

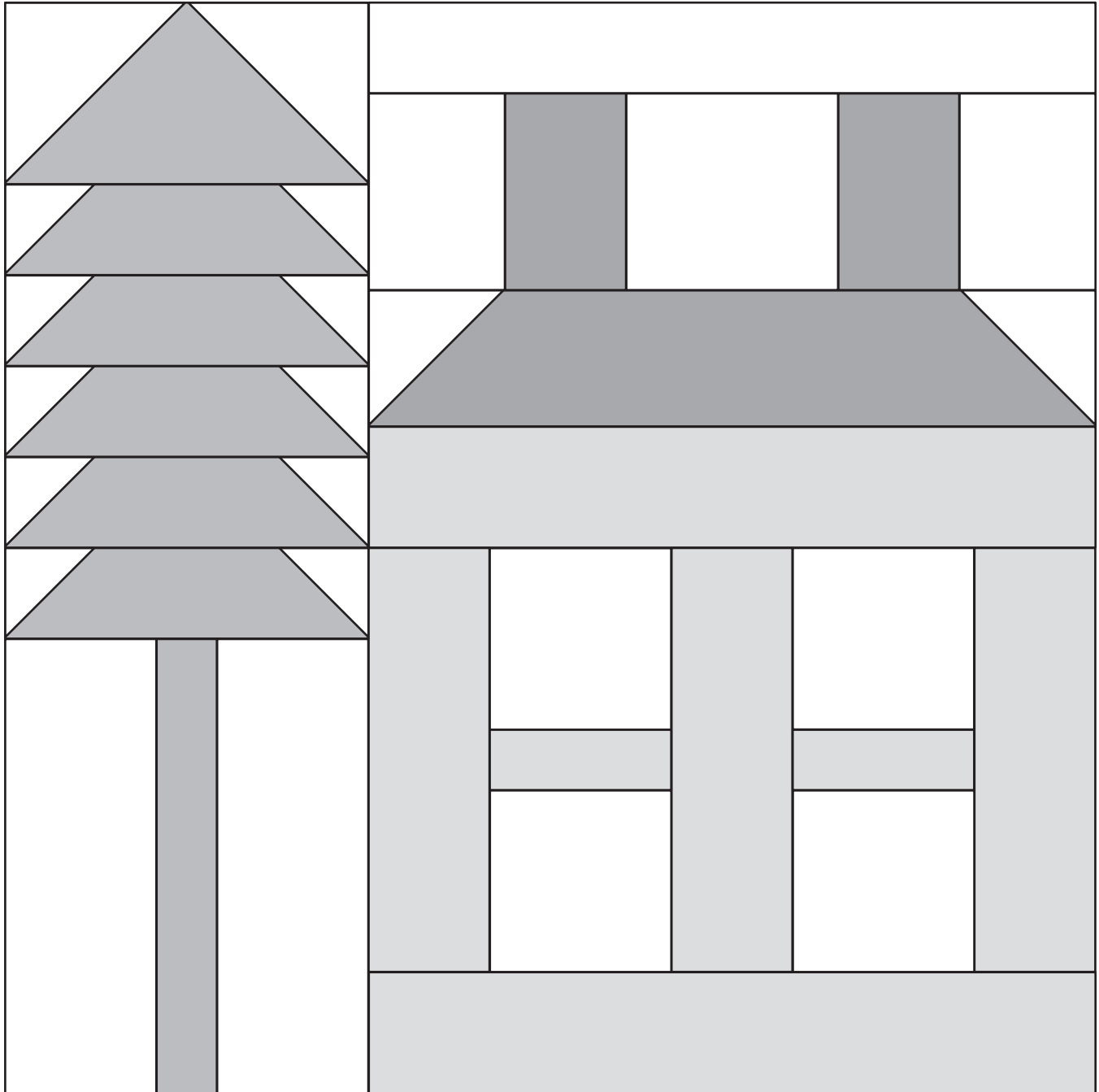

*moda*

# Be My Neighbor

**Block 1**  
18" x 18" finished



## General Information

- These are very scrappy blocks. Mix your favorite Moda prints to create your colorful neighborhood!
- Share your progress and final quilt at #BeMyNeighbor. We love to see your results!!!

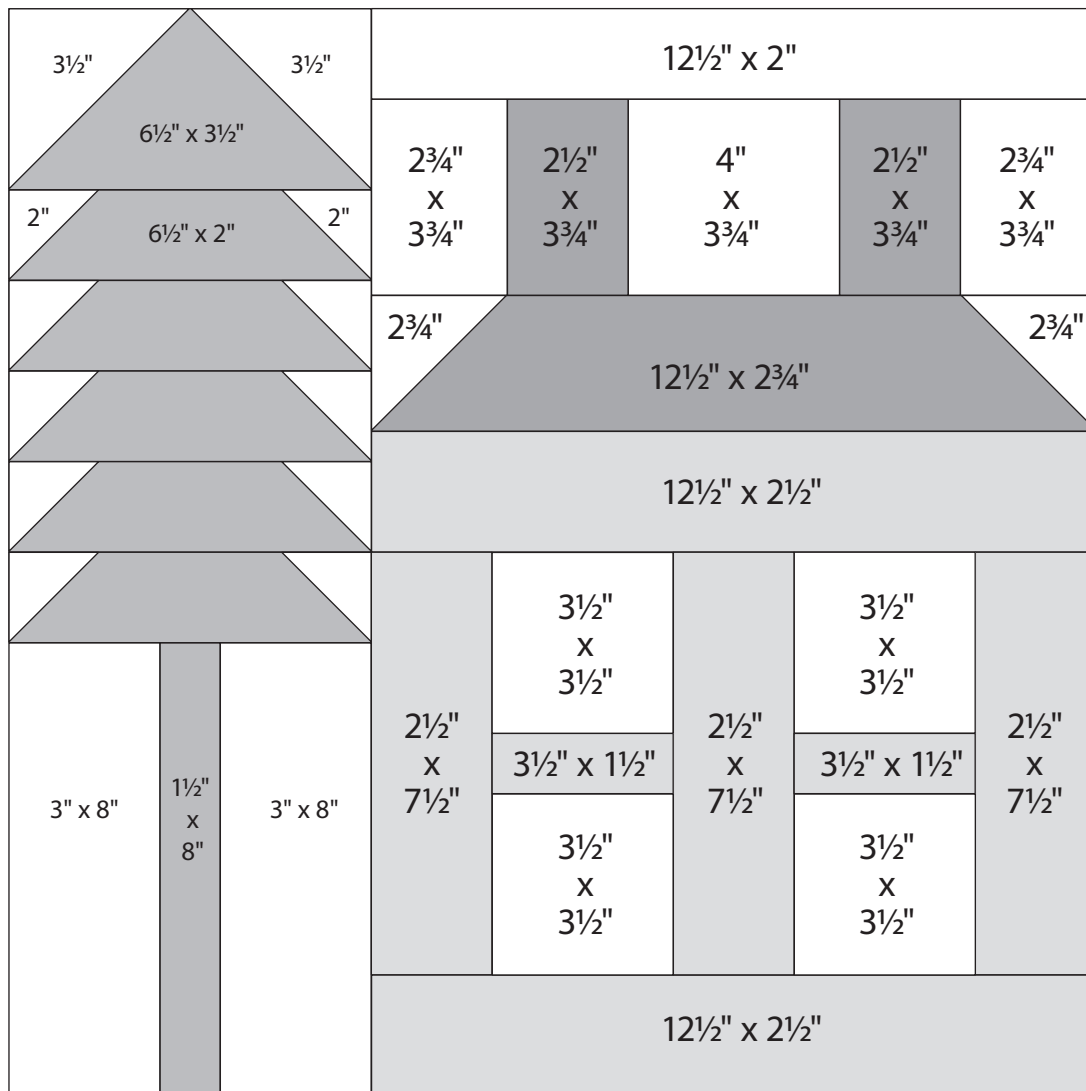

**Block 1**  
18½" x 18½" unfinished

## Cutting

### House

- 2–12½" x 2½" rectangles
- 2–3½" x 1½" rectangles
- 3–2½" x 7½" rectangles

### Windows

- 4–3½" squares

### Roof and Chimneys

- 1–12½" x 2¾" rectangle
- 2–2½" x 3¾" rectangles

### Tree

- 1–6½" x 3½" rectangle
- 5–6½" x 2" rectangles

### Tree Trunk

- 1–1½" x 8" rectangle

### Background

- 10–2" squares
- 1–2" x 12½" rectangle
- 2–2¾" squares
- 2–2¾" x 3¾" rectangles
- 1–3¾" x 4" rectangle
- 2–3" x 8" rectangles
- 2–3½" squares



# moda Be My Neighbor

Block 1 is 18" x 18" finished.

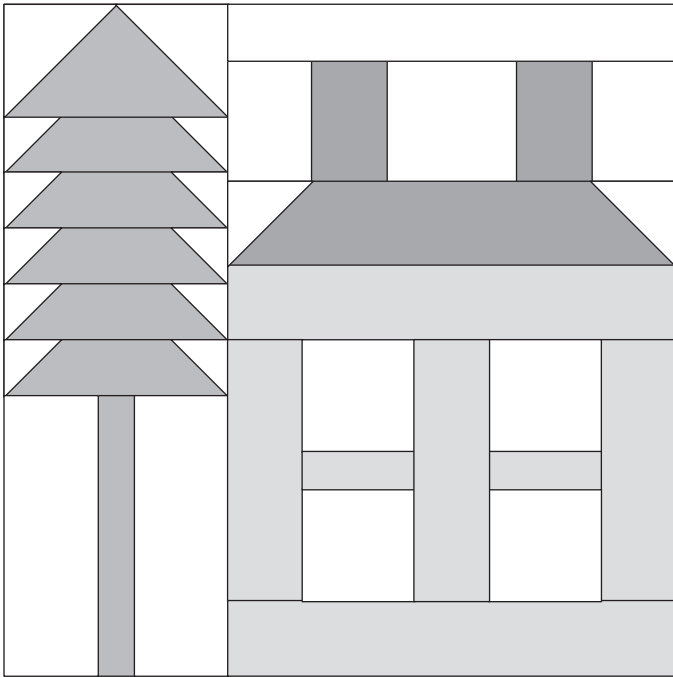

## Construction

Use 1/4" seams. Press in the direction of the arrows in the diagrams.

### 1 Tree

(A) Draw a diagonal line from corner to corner on the wrong side of 2-3 1/2" background squares. Layer a 3 1/2" marked background square, right sides together, on 1-6 1/2" x 3 1/2" tree rectangle as shown. Sew on the diagonal line. Trim 1/4" from the sewn line. Press to reveal the triangle. Repeat on the opposite end of the same rectangle. Make 1.

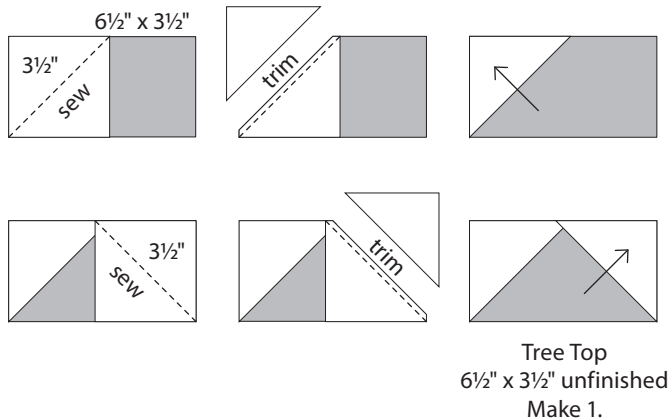

tree continued . . . . .

(B) Draw a diagonal line from corner to corner on the wrong side of 10-2" background squares. Layer 2" marked background square, right sides together, on 1-6 1/2" x 2" tree rectangle as shown. Sew on the diagonal line. Trim 1/4" from the sewn line. Press to reveal the triangle. Repeat on the opposite end of the same rectangle. Make 5.

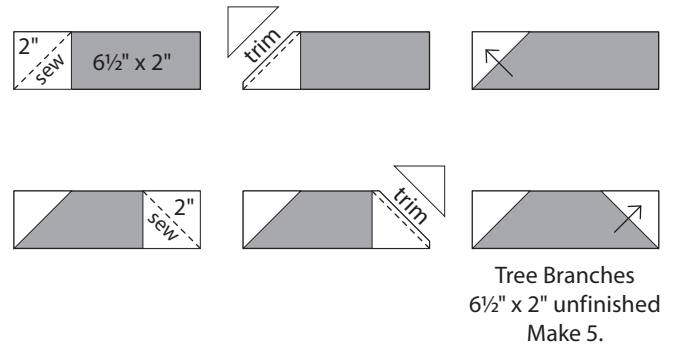

(C) Join 2-3" x 8" background and 1-1 1/2" x 8" tree trunk as shown. Make 1.

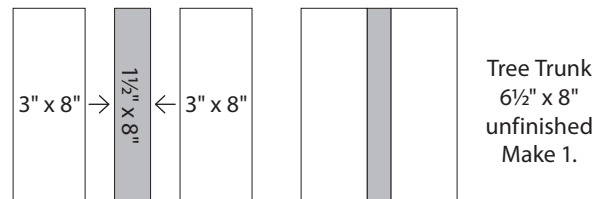

(D) Assemble the tree as shown.

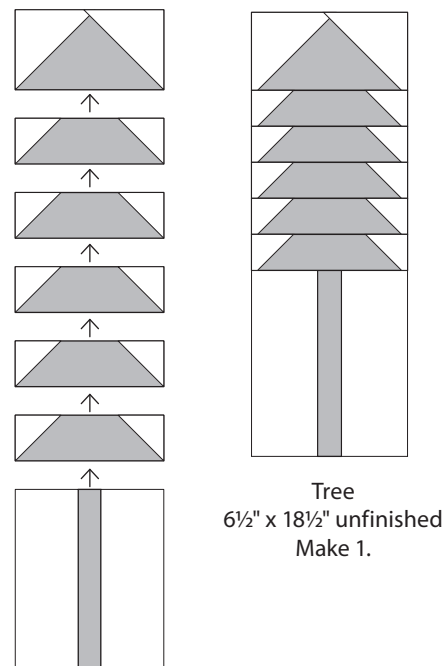

## 2 Chimney, Roof, and Windows

(A) Join  $2-2\frac{3}{4}'' \times 3\frac{3}{4}''$  backgrounds,  $2-2\frac{1}{2}'' \times 3\frac{3}{4}''$  chimneys, and  $1-4'' \times 3\frac{3}{4}''$  background as shown to make the chimneys.

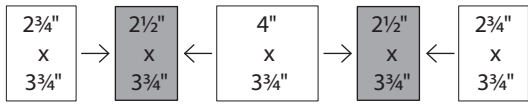

Chimneys  
 $18\frac{1}{2}'' \times 3\frac{3}{4}''$  unfinished  
Make 1.

(B) Draw a diagonal line from corner to corner on the wrong side of  $2-2\frac{3}{4}''$  background squares. Layer a  $2\frac{3}{4}''$  marked background square, right sides to together, on  $1-12\frac{1}{2}'' \times 2\frac{3}{4}''$  roof rectangle as shown. Sew on the diagonal line. Trim  $\frac{1}{4}''$  from the sewn line. Press to reveal the triangle. Repeat on the opposite end of the same rectangle.

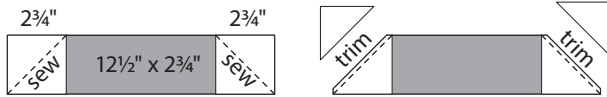

Roof  
 $12\frac{1}{2}'' \times 2\frac{3}{4}''$  unfinished  
Make 1.

(C) Assemble the windows as shown.

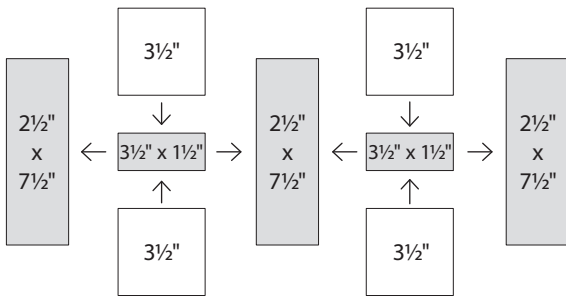

Window  
 $12\frac{1}{2}'' \times 7\frac{1}{2}''$  unfinished  
Make 1.

3 Assemble the house as shown.

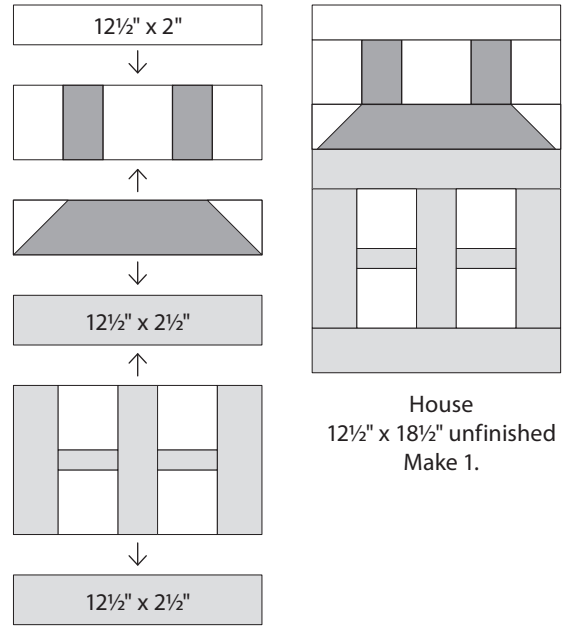

House  
 $12\frac{1}{2}'' \times 18\frac{1}{2}''$  unfinished  
Make 1.

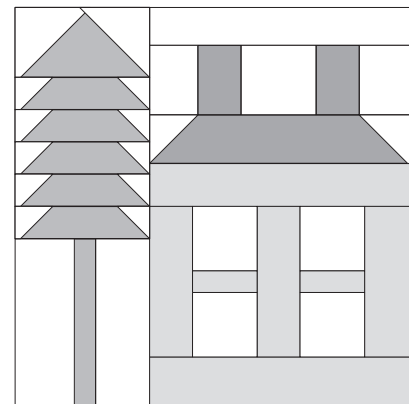
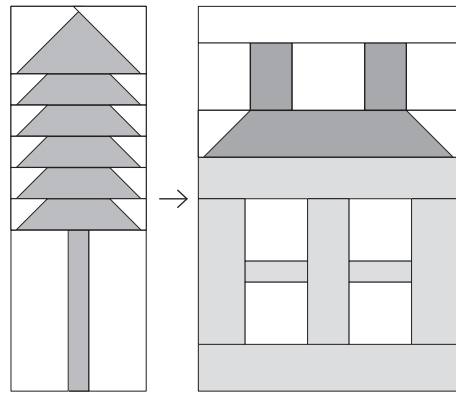

Block 1  
 $18\frac{1}{2}'' \times 18\frac{1}{2}''$  unfinished.

*moda*



*moda*

# Be My Neighbor

**Block 2**  
15" x 18" finished

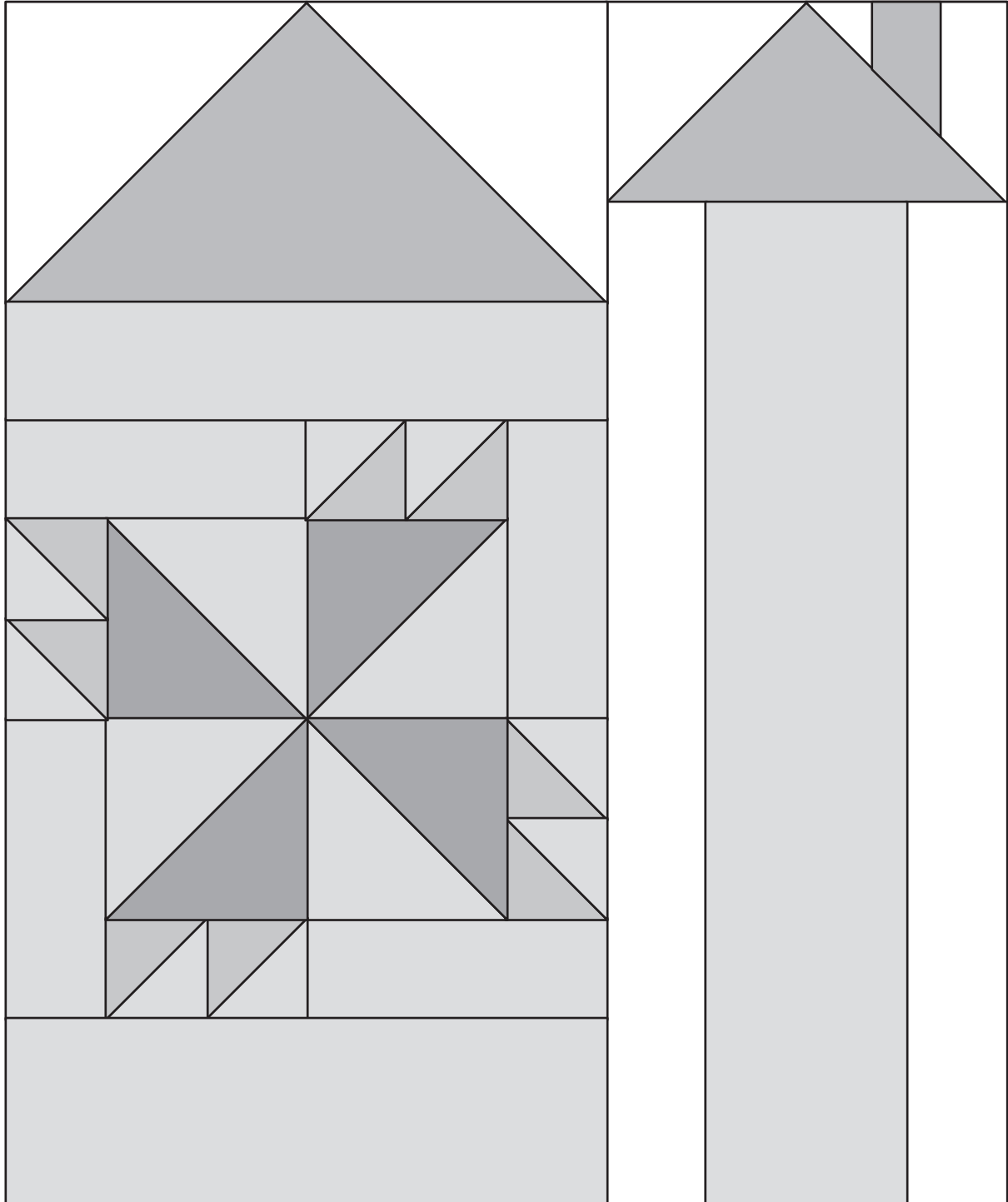

## General Information

- These are very scrappy blocks. Mix your favorite Moda prints to create your colorful neighborhood!
- Share your progress and final quilt at #BeMyNeighbor. We love to see your results!!!

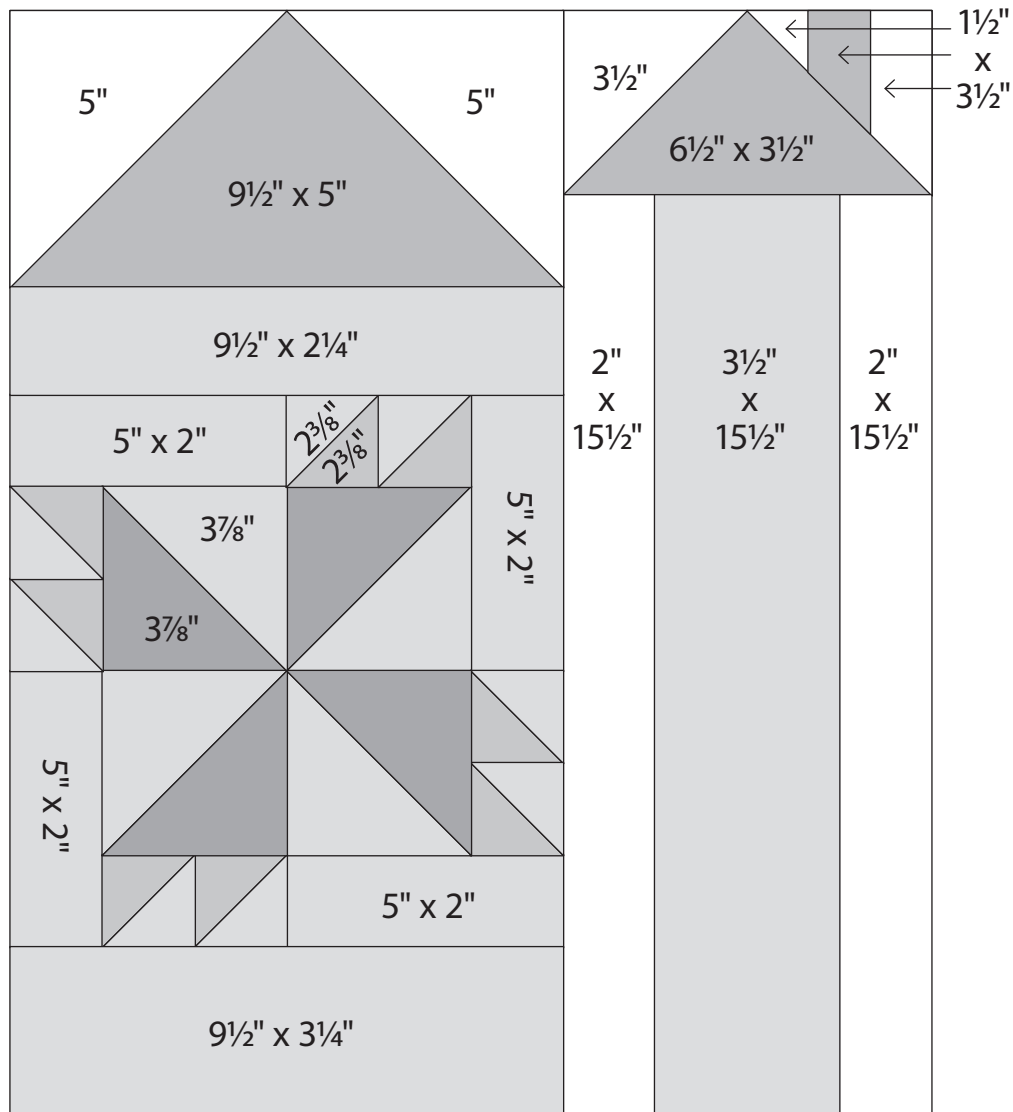

**Block 2**  
15½" x 18½" unfinished

## Cutting

### House

- 1–9½" x 3¼" rectangle
- 1–9½" x 2¼" rectangle
- 4–5" x 2" rectangles
- 2–3⅞" squares
  - cut in half once on the diagonal to make 4 half-square triangles
- 4–2⅜" squares
  - cut in half once on the diagonal to make 8 half-square triangles

### House Roof

- 1–9½" x 5" rectangle

### Pinwheel

- 2–3⅞" squares
  - cut in half once on the diagonal to make 4 half-square triangles

### Pinwheel Points

- 4–2⅜" squares
  - cut in half once on the diagonal to make 8 half-square triangles

### Tower

- 1–3½" x 15½" rectangle

### Tower Roof

- 1–6½" x 3½" rectangle

### Tower Chimney

- 1–3½" x 1½" rectangle

### Background

- 2–5" squares
- 1–3½" square
- 2–3½" x 1½" rectangles
- 2–2" x 15½" rectangles



# Be My Neighbor

Block 2 is 15" x 18" finished.

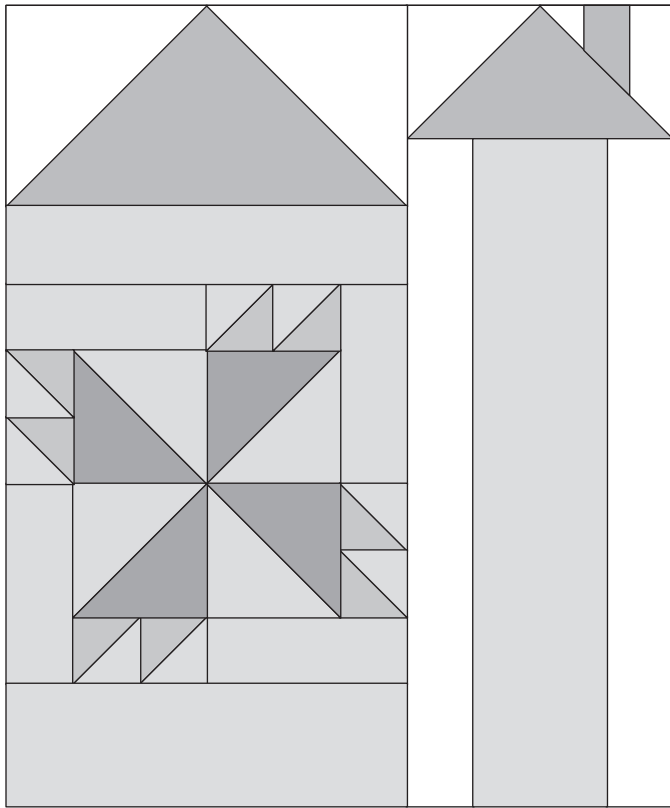

## Construction

Use 1/4" seams. Press in the direction of the arrows in the diagrams.

### 1 House Roof

Draw a diagonal line from corner to corner on the wrong side of 2–5" background squares. Layer a 5" marked background square, right sides to together, on 1–9 1/2" x 5" roof rectangle as shown. Sew on the diagonal line. Trim 1/4" from the sewn line. Press to reveal the triangle. Repeat on the opposite end of the same rectangle. Make 1.

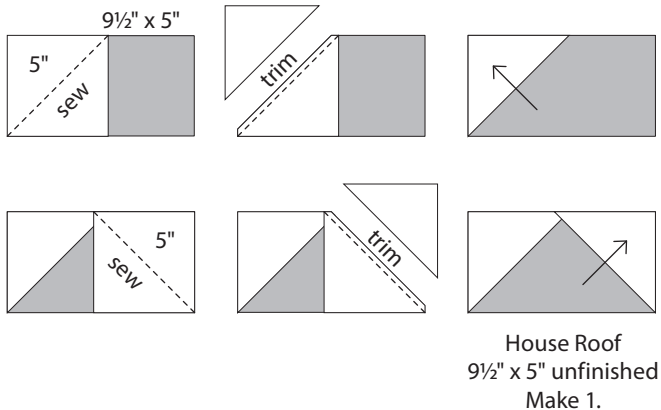

### 2 Pinwheel with points

(A) Join one 2 3/8" house and one 2 3/8" point half-square triangle to make a 2" point half-triangle square. Make 8. Join 2 HTSs to make 1 point pair. Make 4.

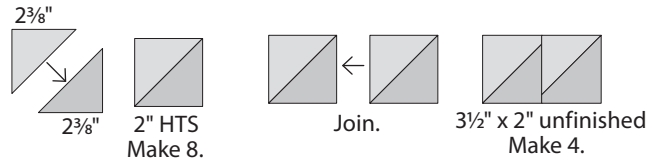

(B) Join one 3 7/8" house and one 3 7/8" pinwheel half-square triangle to make a 3 1/2" pinwheel half-triangle square. Make 4.

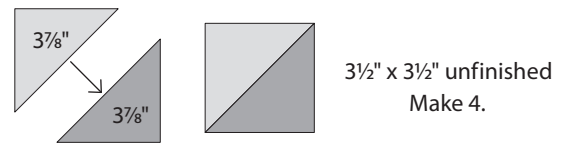

(C) Assemble a pointed pinwheel as shown.

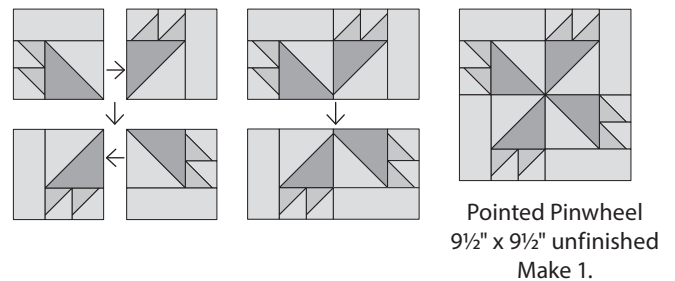
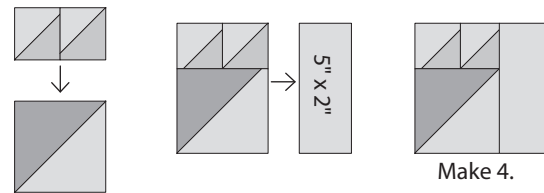

3 Assemble the house as shown.

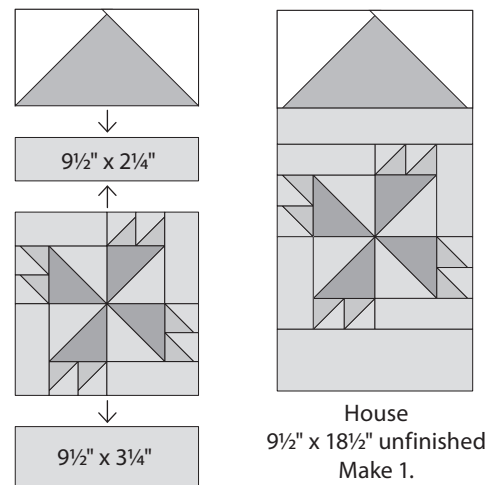

#### 4 Assemble the tower.

(A) Join 2-1½" x 3½" backgrounds and 1-1½" x 3½" chimney to make the chimney.

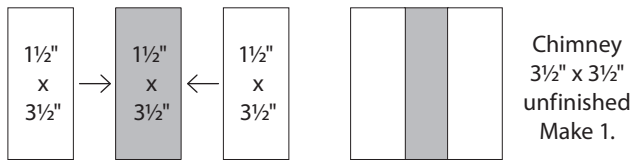

(B) Draw a diagonal line from corner to corner on the wrong side of the chimney square and a 3½" background square. Layer the marked background square, right sides to together, on 1-6½" x 3½" roof rectangle as shown. Sew on the diagonal line. Trim ¼" from the sewn line. Press to reveal the triangle. Repeat on the opposite end of the same rectangle using the marked chimney square. Make 1.

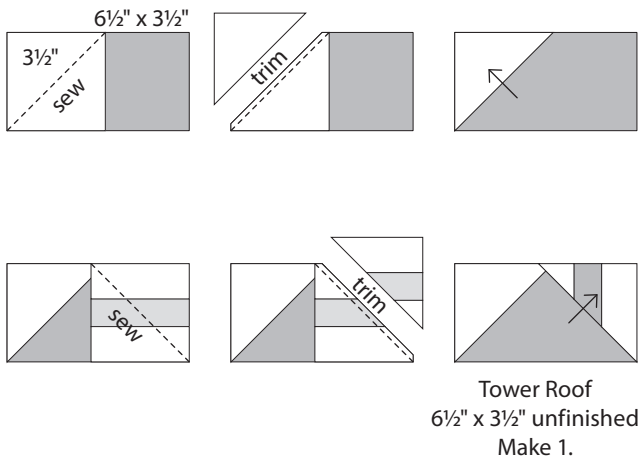

(C) Join 2-2" x 15½" backgrounds and 1-3½" x 15½" tower as shown.

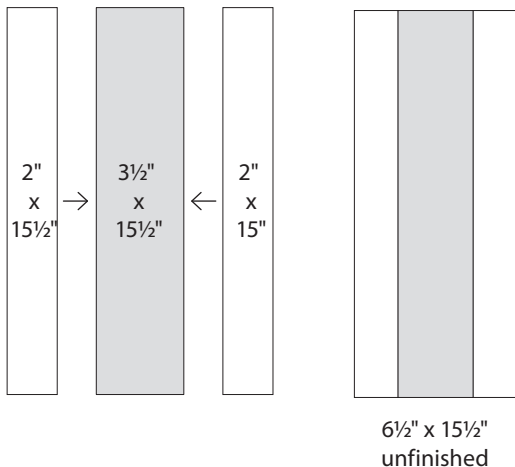

(C) Add the roof to finish the tower.

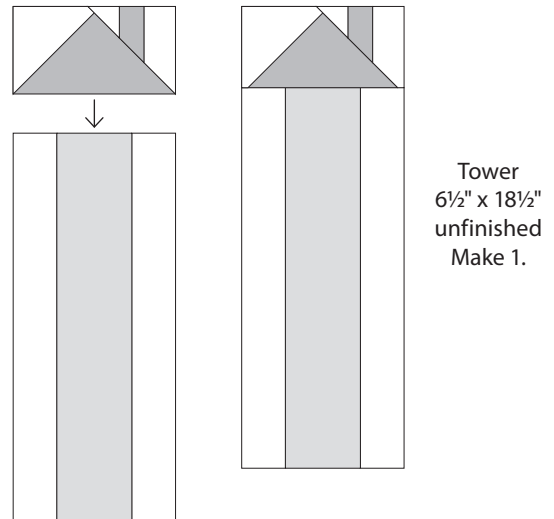

*moda*

#### 5 Assemble the block as shown.

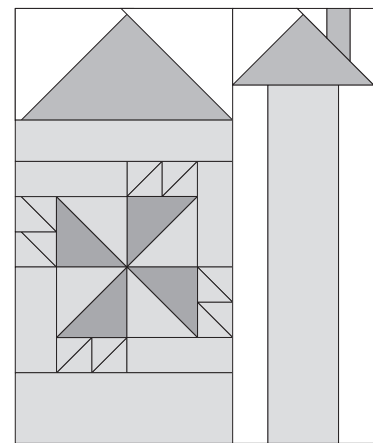
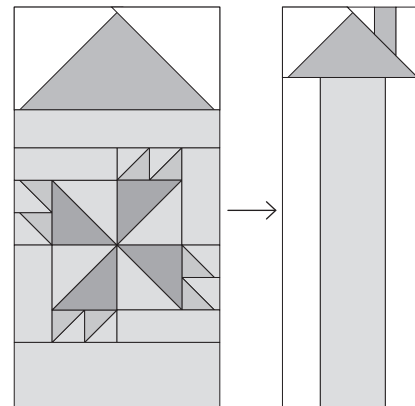

**Block 2**  
15½" x 18½" unfinished





*moda*

# Be My Neighbor

**Block 3**  
15" x 18" finished

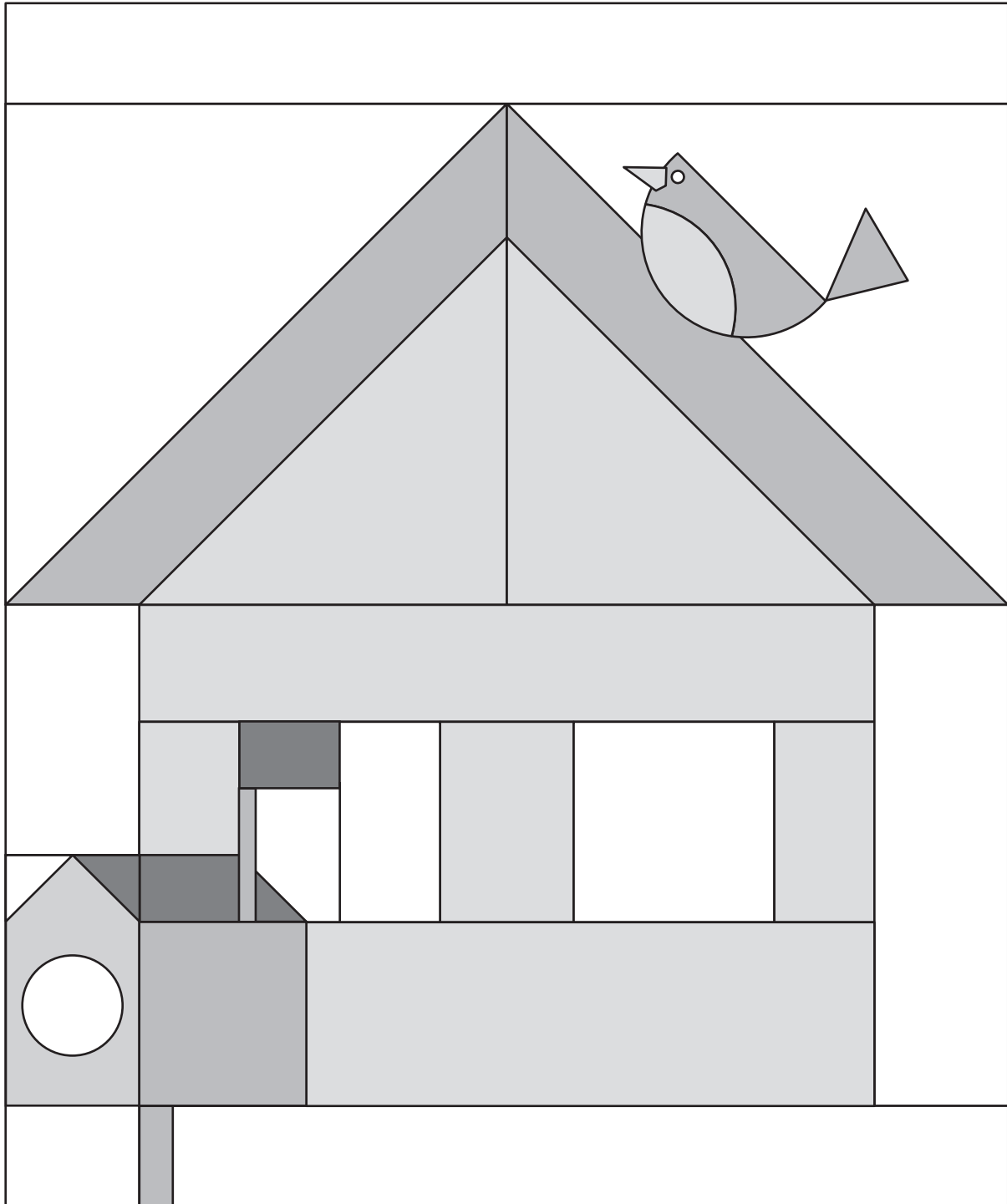

## General Information

- These are very scrappy blocks. Mix your favorite Moda prints to create your colorful neighborhood!
- Share your progress and final quilt at #BeMyNeighbor. We love to see your results!!!

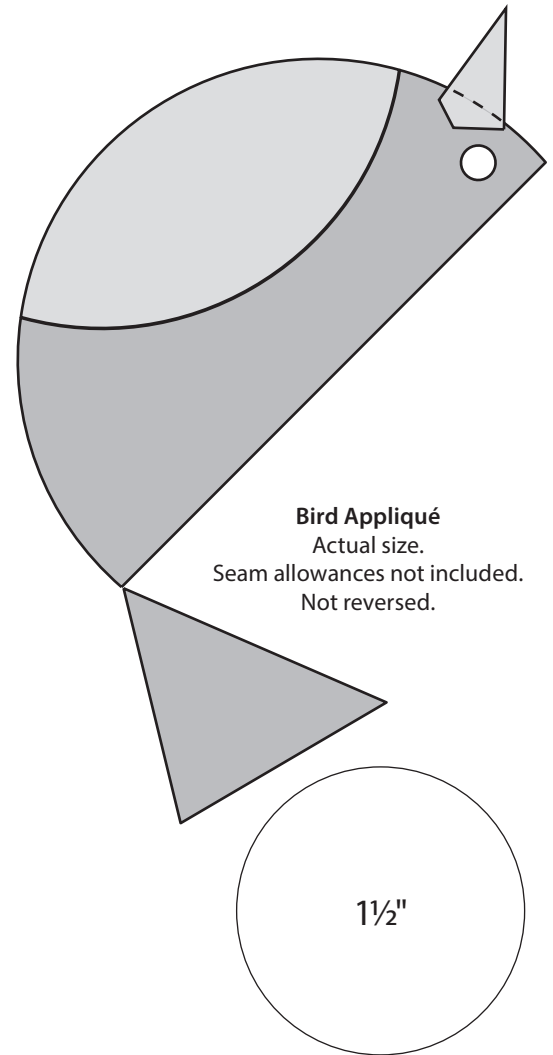
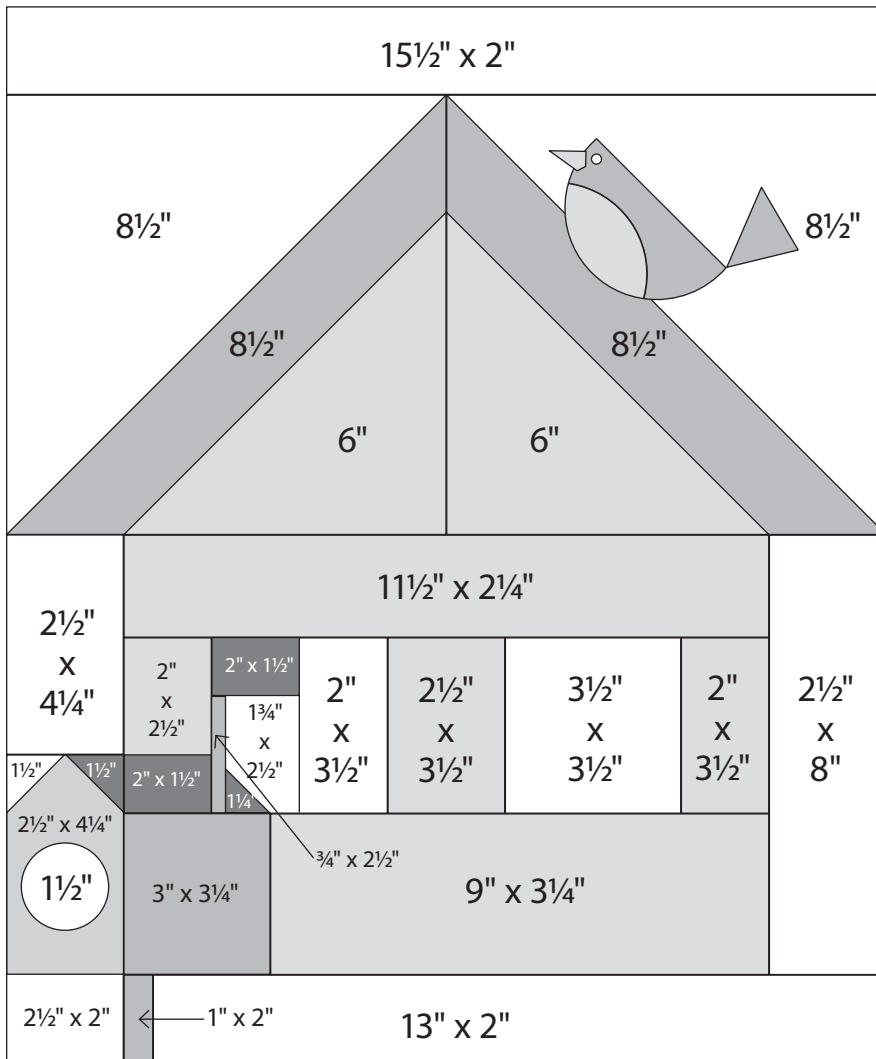

**Block 3**  
15 1/2" x 18 1/2" unfinished

## Cutting

### House

- 1-11 1/2" x 2 1/4" rectangle
- 1-9" x 3 1/4" rectangle
- 2-6" squares
- 1-2 1/2" x 3 1/2" rectangle
- 1-2" x 3 1/2" rectangle
- 1-2" x 2 1/2" rectangle

### House Roof

- 1-8 1/2" square  
cut in half once on the diagonal to make 2 half-square triangles

### Mailbox Front

- 1-2 1/2" x 4 1/4" rectangle
- 1-1 1/2" circle

### Mailbox Side and Pole

- 1-3" x 3 1/4" rectangle
- 1-1" x 2" rectangle

### Mailbox Roof

- 1-1 1/4" square
- 1-1 1/2" square
- 1-2" x 1 1/2" rectangle

### Windows

- 1-3 1/2" square
- 1-2" x 3 1/2" rectangle
- 1-1 3/4" x 2 1/2" rectangle

### Flag

- 1-2 1/2" x 1 1/2" rectangle

### Flag Pole

- 1-3/4" x 2 1/2" rectangle

### Bird Appliqué

- 1-beak
- 1-body
- 1-tail
- 1-wing
- 1-eye

### Background

- 1-15 1/2" x 2" rectangle
- 1-13" x 2" rectangle
- 1-8 1/2" square  
cut in half once on the diagonal to make 2 half-square triangles
- 1-2 1/2" x 8" rectangle
- 1-2 1/2" x 4 1/4" rectangle
- 1-2 1/2" x 2" rectangle
- 1-1 1/2" square



# moda Be My Neighbor

Block 3 is 15" x 18" finished.

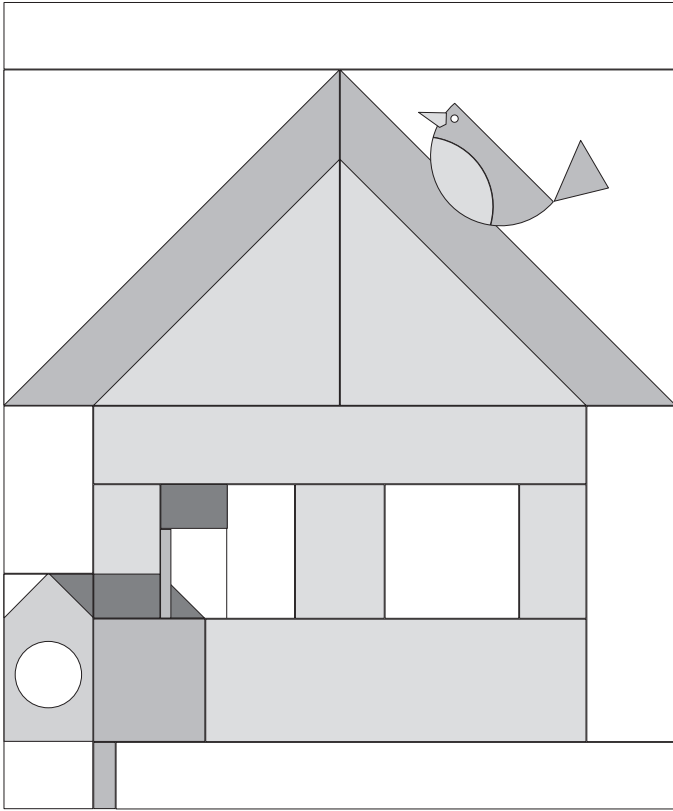

## Construction

Use  $\frac{1}{4}$ " seams. Press in the direction of the arrows in the diagrams.

### 1 House Roof

- (A) Join one  $8\frac{1}{2}$ " roof and one  $8\frac{1}{2}$ " background half-square triangle to make one half-triangle square (HTS). Make 2. Trim to 8".

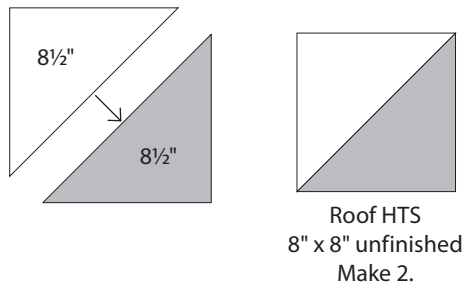

moda

house roof continued . . .

- (B) Draw a diagonal line from corner to corner on the wrong side of 2–6" house squares. Layer a marked house square, right sides to together, on a roof HTS as shown. Sew on the diagonal line. Trim the 6" house square only,  $\frac{1}{4}$ " from the diagonal line. Press to reveal the triangle. Make 2. Join to make the house roof.

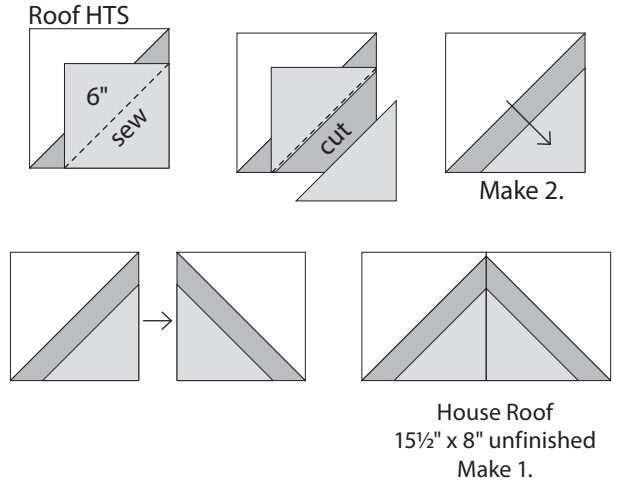

### 2 Mailbox

- Draw a diagonal line from corner to corner on the wrong side of 1–1 1/2" background and 1–1 1/2" mailbox roof squares. Layer a marked background square, right sides to together, on the  $2\frac{1}{2}$ " x  $4\frac{1}{4}$ " mailbox front as shown. Sew on the diagonal line. Trim  $\frac{1}{4}$ " from the diagonal line. Press to reveal the triangle. Repeat using the marked  $1\frac{1}{2}$ " mailbox square on the opposite corner as shown. Appliqué the circle to the front. Add a  $2\frac{1}{2}$ " x  $4\frac{1}{4}$ " background rectangle as shown.

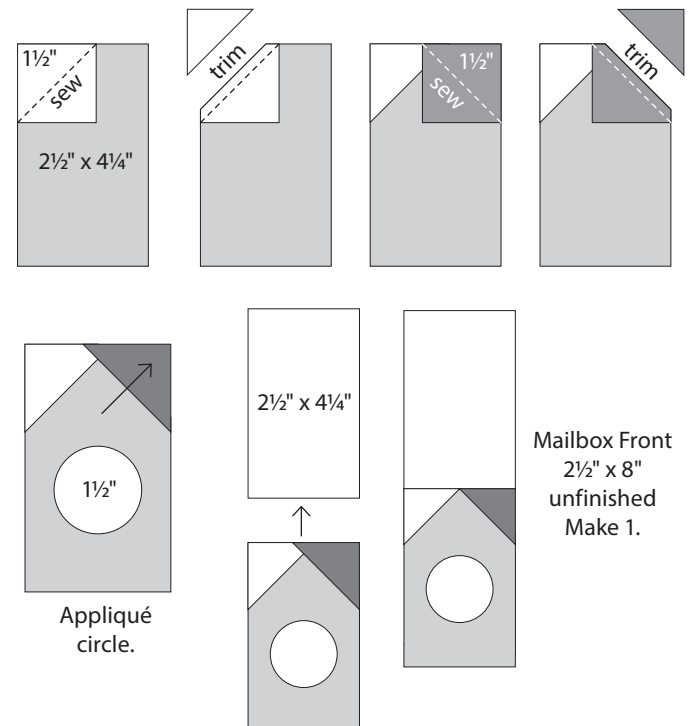

### 3 Mailbox Flag and House Windows

Draw a diagonal line from corner to corner on the wrong side of 1-1/4" mailbox roof square. Layer the marked square, right sides to together, on the 1 3/4" x 2 1/2" window as shown. Sew on the diagonal line. Trim 1/4" from the diagonal line. Press to reveal the triangle.

Follow the steps to assemble the mailbox flag and house windows.

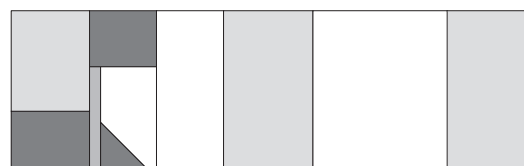
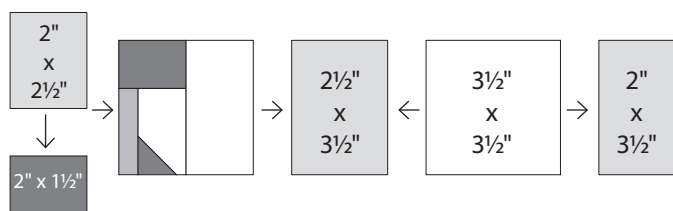
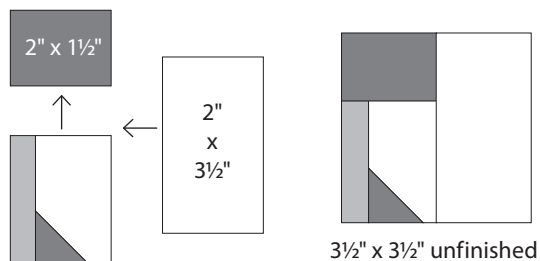
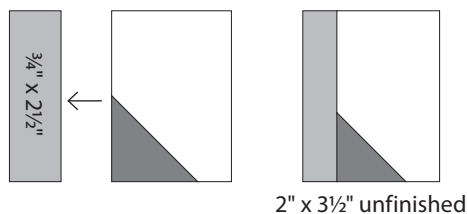
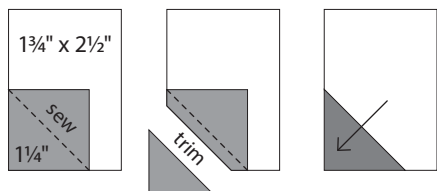

Mailbox Flag and House Windows  
1 1/2" x 3 1/2" unfinished

### 4 Assemble the block.

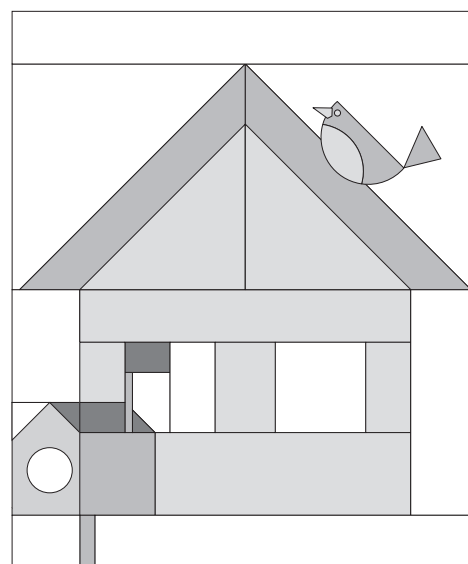
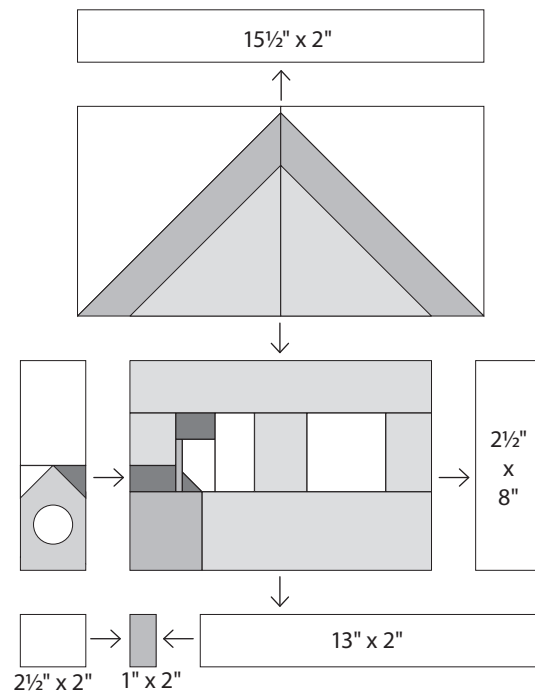
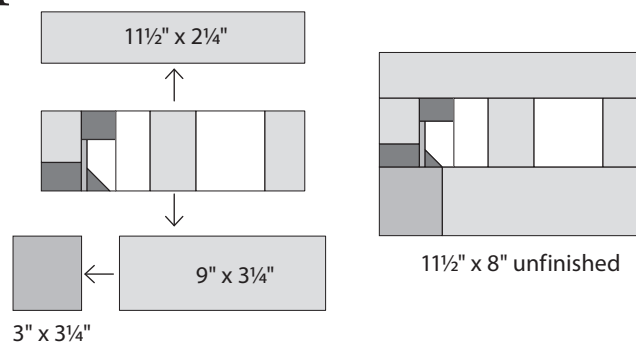

Block 3  
15 1/2" x 18 1/2" unfinished



*moda*

# Be My Neighbor

## Block 4

12" x 18" finished

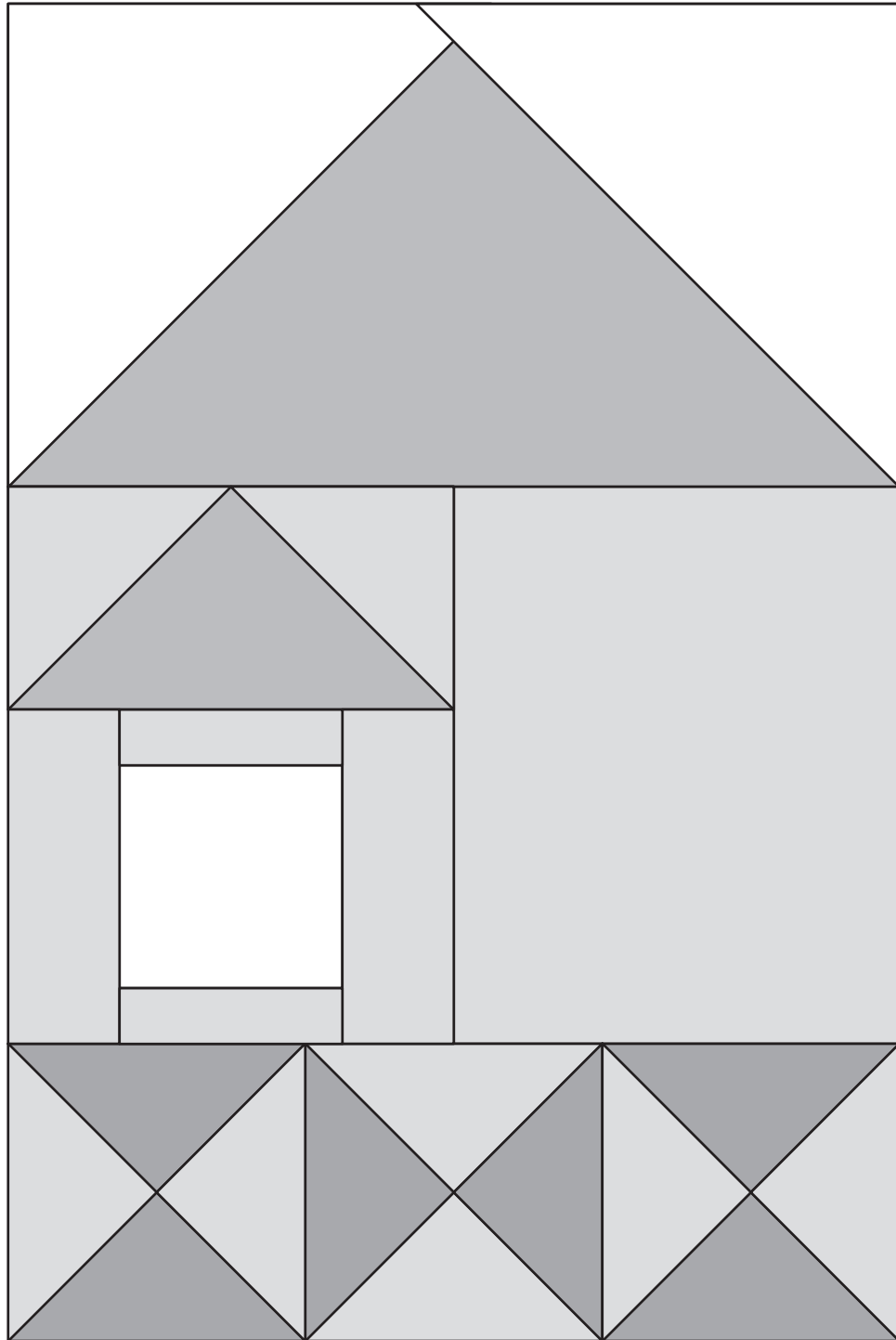

## General Information

---

- These are very scrappy blocks. Mix your favorite Moda prints to create your colorful neighborhood!
- Share your progress and final quilt at #BeMyNeighbor. We love to see your results!!!

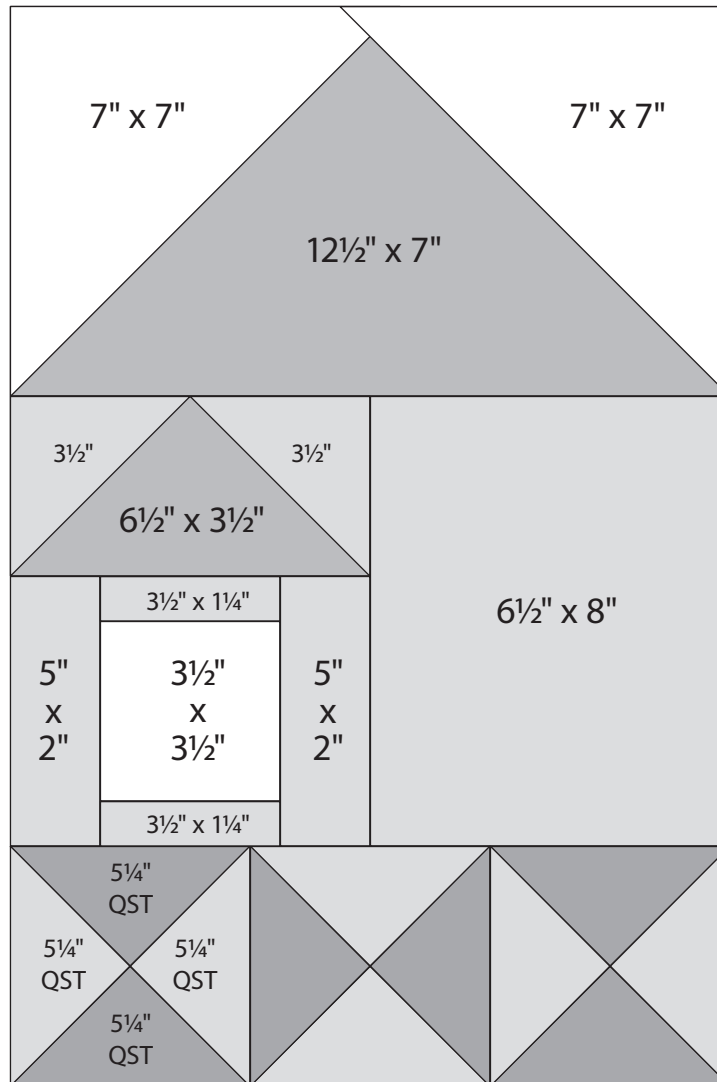

**Block 4**  
12 1/2" x 18 1/2" unfinished

## Cutting

---

### House Roof Large

1-12 1/2" x 7" rectangle

### House Roof Small

1-6 1/2" x 3 1/2" rectangle

### Quarter-Square Triangles

2-5 1/4" squares

cut in half twice on the diagonal to  
make 8 quarter-square triangles (need 6)

### House

1-6 1/2" x 8" rectangle

2-5 1/4" squares

cut in half twice on the diagonal to  
make 8 quarter-square triangles (need 6)

2-5" x 2" rectangles

2-3 1/2" squares

2-3 1/2" x 1 1/4" rectangles

### Window

1-3 1/2" square

### Background

2-7" squares



moda  
Be My Neighbor

Block 4 is 12" x 18" finished.

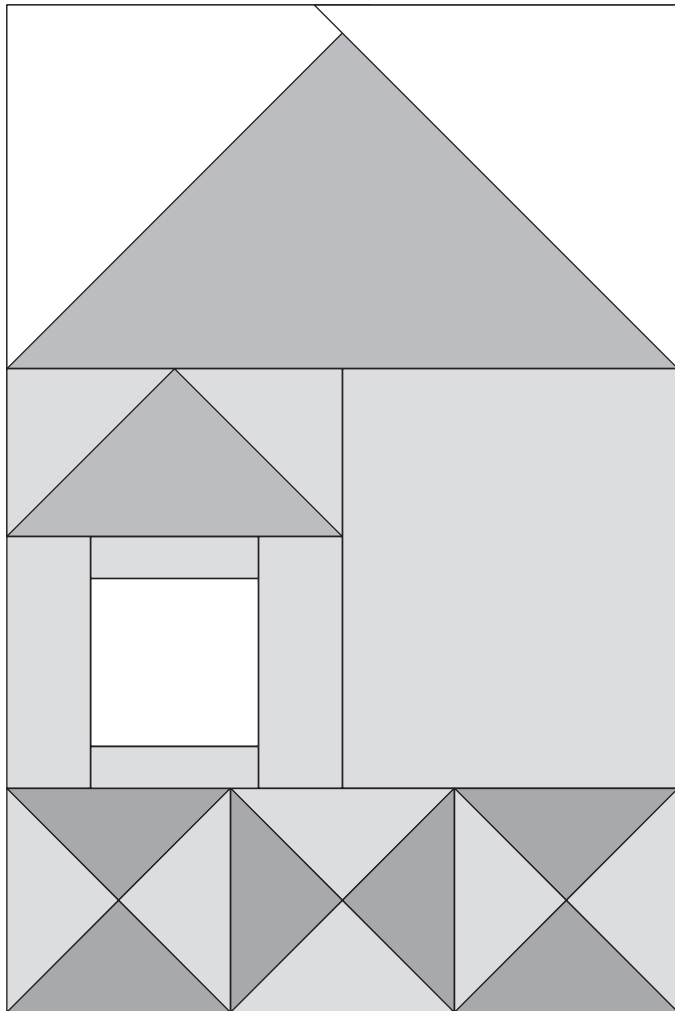

moda

## Construction

Use ¼" seams. Press in the direction of the arrows in the diagrams.

### 1 House Roof Large

Draw a diagonal line from corner to corner on the wrong side of 2-7" background squares. Layer a 7" marked background square, right sides to together, on 1-12½" x 7" large roof rectangle as shown. Sew on the diagonal line. Trim ¼" from the sewn line. Press to reveal the triangle. Repeat on the the opposite end of the same rectangle. Make 1.

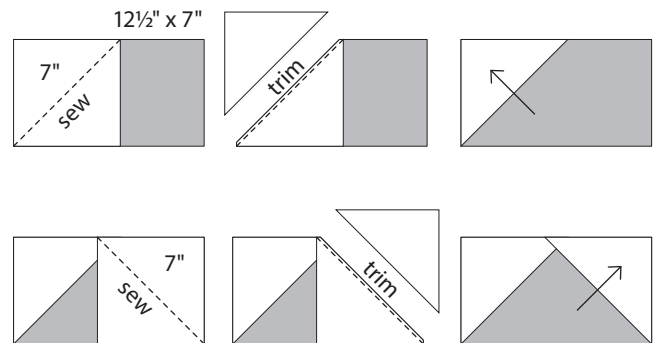

House Roof Large  
12½" x 7" unfinished  
Make 1.

### 2 House Roof Small

Draw a diagonal line from corner to corner on the wrong side of 2-3½" house squares. Layer a 3½" marked house square, right sides to together, on 1-6½" x 3½" small roof rectangle as shown. Sew on the diagonal line. Trim ¼" from the sewn line. Press to reveal the triangle. Repeat on the the opposite end of the same rectangle. Make 1.

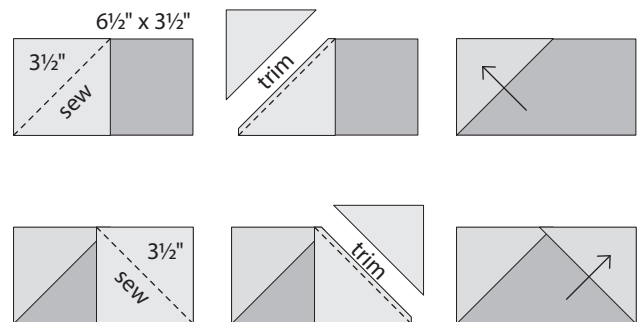

House Roof Small  
6½" x 3½" unfinished  
Make 1.

3 Assemble the window section as shown.

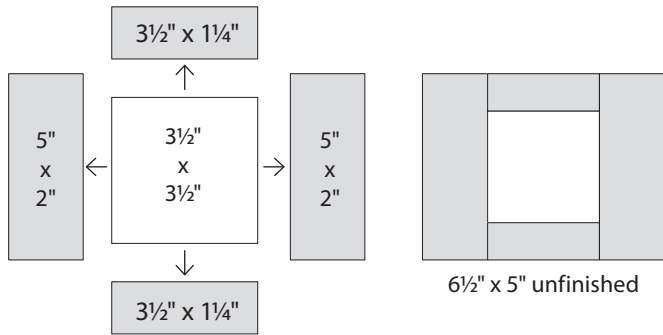

House Roof Small

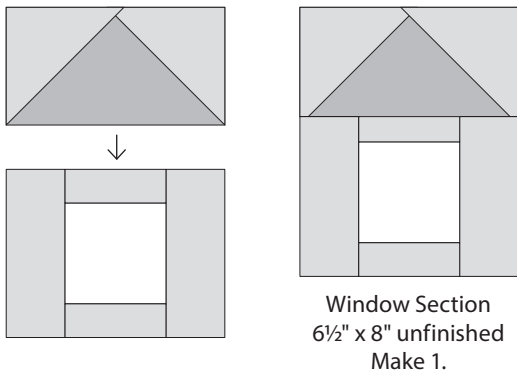

4 House Base

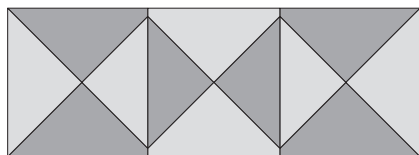
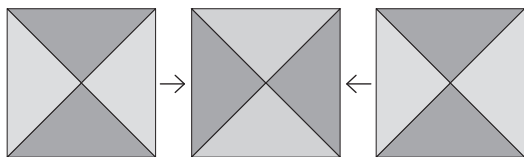
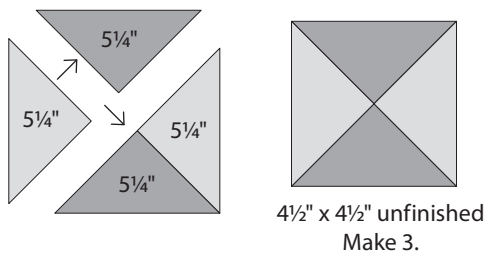

House Base  
 12 1/2" x 4 1/2" unfinished  
 Make 1.

5 Assemble the block as shown.

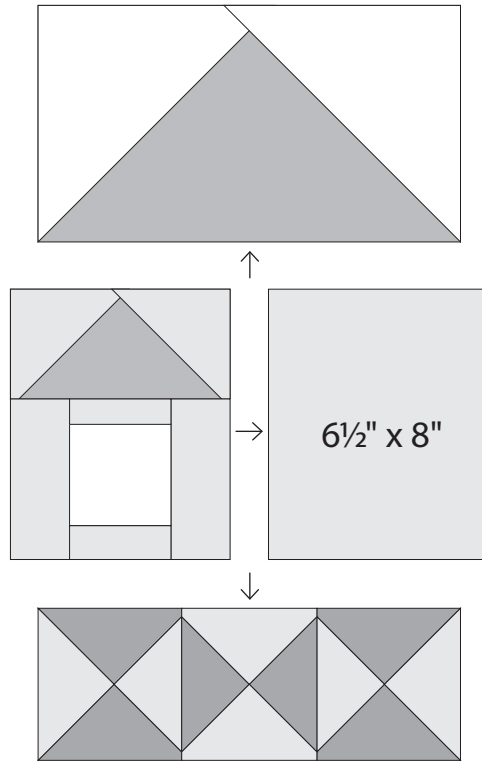

*moda*

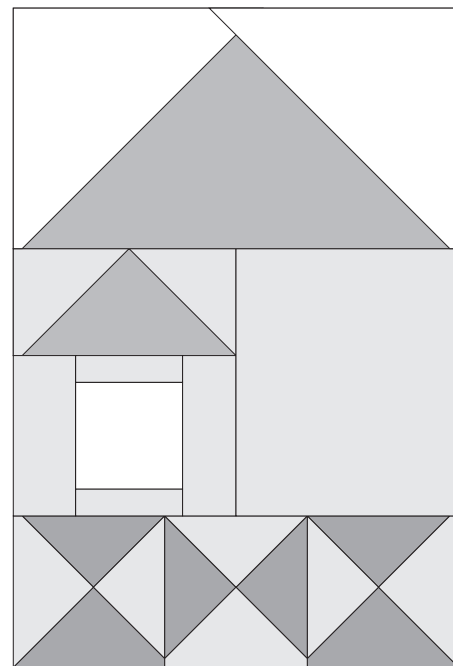

Block 4  
 12 1/2" x 18 1/2" unfinished





*moda*

# Be My Neighbor

## Block 5

12" x 18" finished

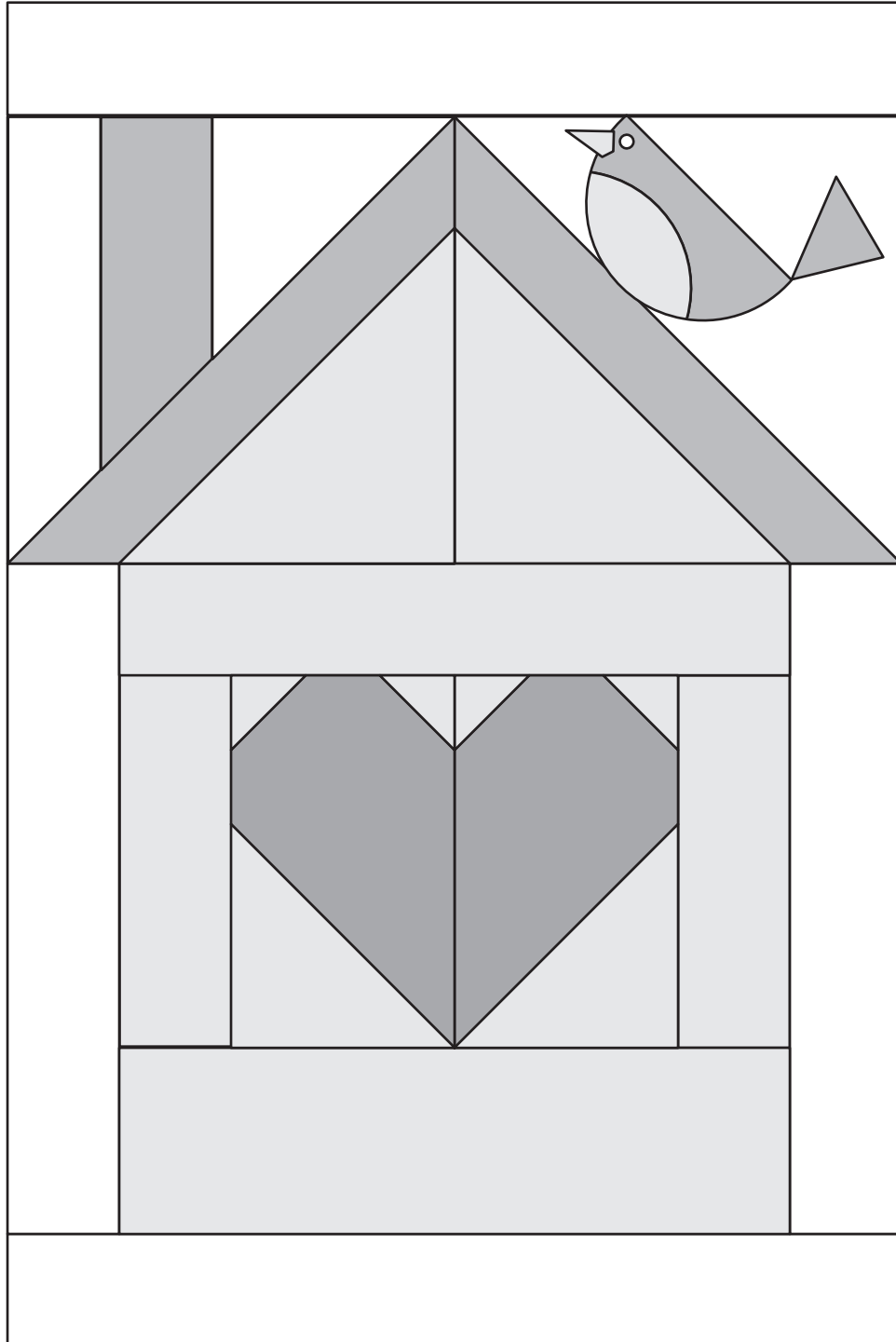

## General Information

- These are very scrappy blocks. Mix your favorite Moda prints to create your colorful neighborhood!
- Share your progress and final quilt at #BeMyNeighbor. We love to see your results!!!

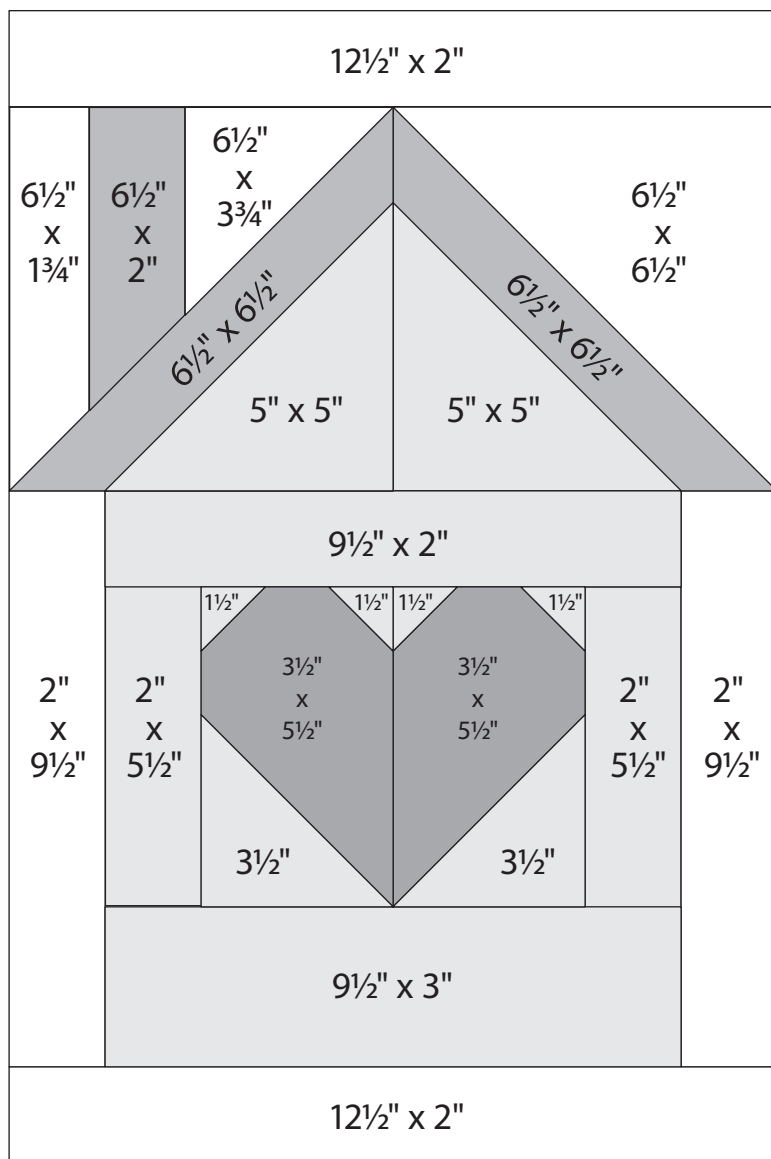

**Block 5**  
12½" x 18½" unfinished

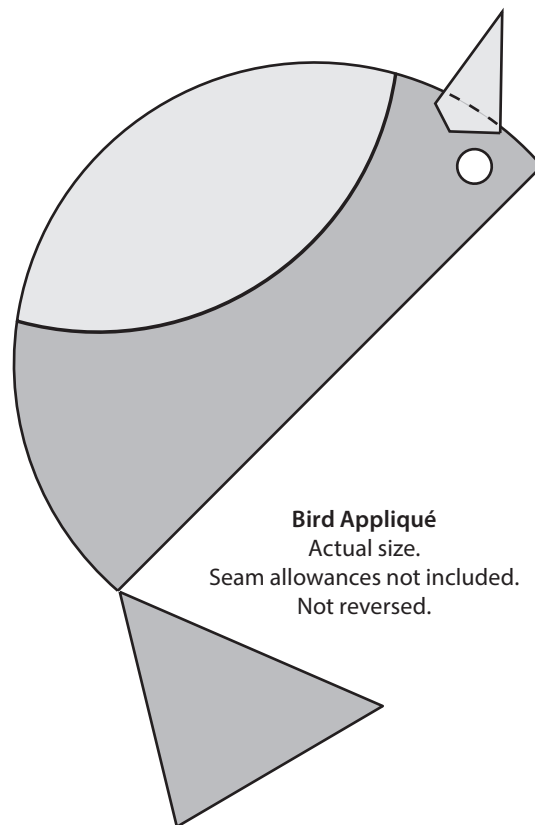

**Bird Appliqué**  
Actual size.  
Seam allowances not included.  
Not reversed.

## Cutting

### House

- 1–9½" x 3" rectangles
- 1–9½" x 2" rectangles
- 2–5½" x 2" rectangles
- 2–5" squares
- 2–3½" squares
- 4–1½" squares

**Roof:** 2–6½" squares

**Chimney:** 1–2" x 6½"

**Heart:** 2–3½" x 5½"

### Background

- 1–6½" square
- 1–6½" x 3¾" rectangle
- 1–6½" x 1¾" rectangle
- 2–2" x 12½" rectangles
- 2–2" x 9½" rectangles

### Bird Appliqué

- 1–beak
- 1–body
- 1–tail
- 1–wing
- 1–eye



# moda Be My Neighbor

Block 5 is 12" x 18" finished.

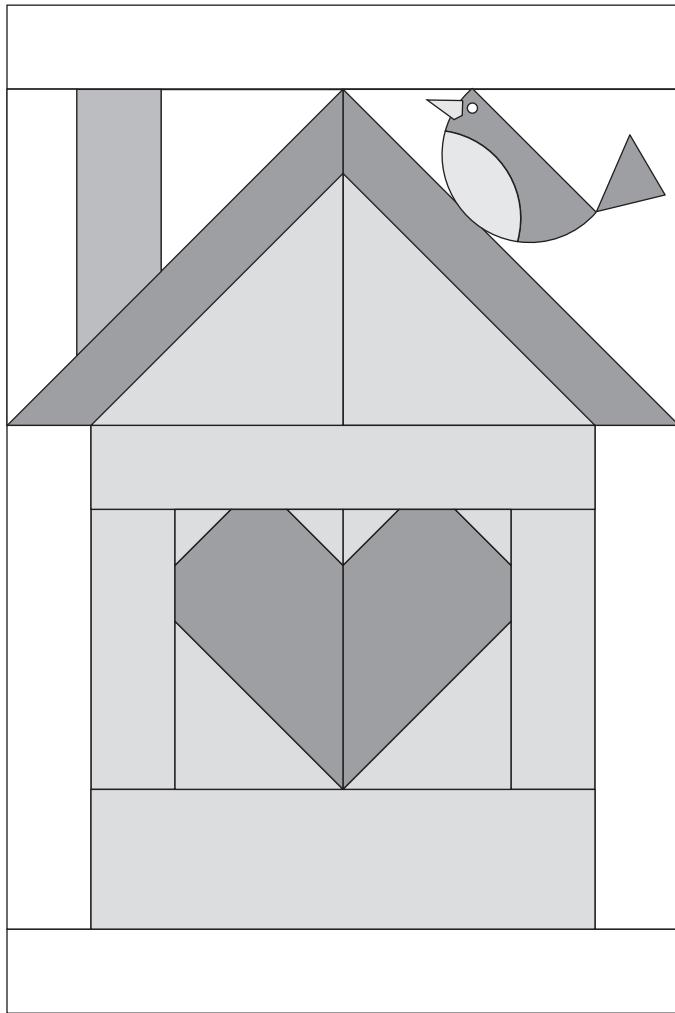

## Construction

Use  $\frac{1}{4}$ " seams. Press in the direction of the arrows in the diagrams.

### 1 Roof

- (A) Join a  $1\frac{3}{4}$ " x  $6\frac{1}{2}$ " background, 2" x  $6\frac{1}{2}$ " chimney, and  $3\frac{3}{4}$ " x  $6\frac{1}{2}$ " background strip as shown.

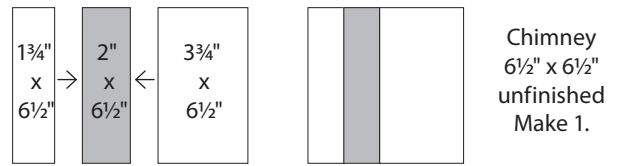

- (B) Draw a diagonal line from corner to corner on the wrong side of 2–5" house squares. Layer a 5" marked background square, right sides to together, on 1– $6\frac{1}{2}$ " roof square as shown. Sew on the diagonal line. Trim  $\frac{1}{4}$ " from the sewn line. Press to reveal the triangle. Make 2.

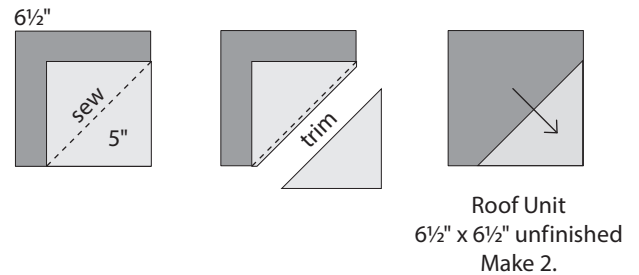

- (C) Draw a diagonal line from corner to corner on the wrong side of the chimney as shown. Layer the marked chimney, right sides together, on a roof unit as shown. Sew, trim, and press. Make 1.

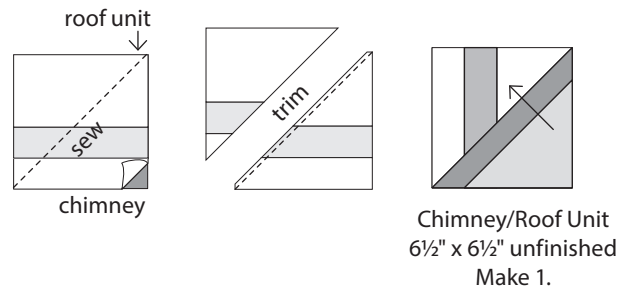

moda

(D) Draw a diagonal line from corner to corner on the wrong side of a 6½" background square. Layer the marked square, right sides together, on a roof unit as shown. Sew, trim, and press to reveal the triangle. Make 1. Join units to make the roof.

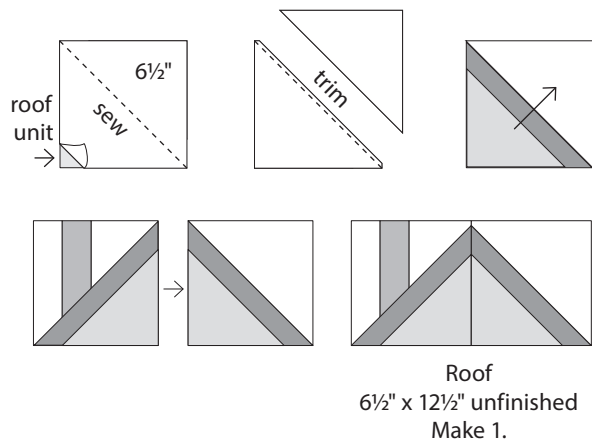

**2 Heart** Draw a diagonal line from corner to corner on the wrong side of 2–3½" house squares, and 4–1½" house squares. Layer, sew, trim, and press as shown on 2–3½" x 5½" hearts. Join the 2 sides to make the heart.

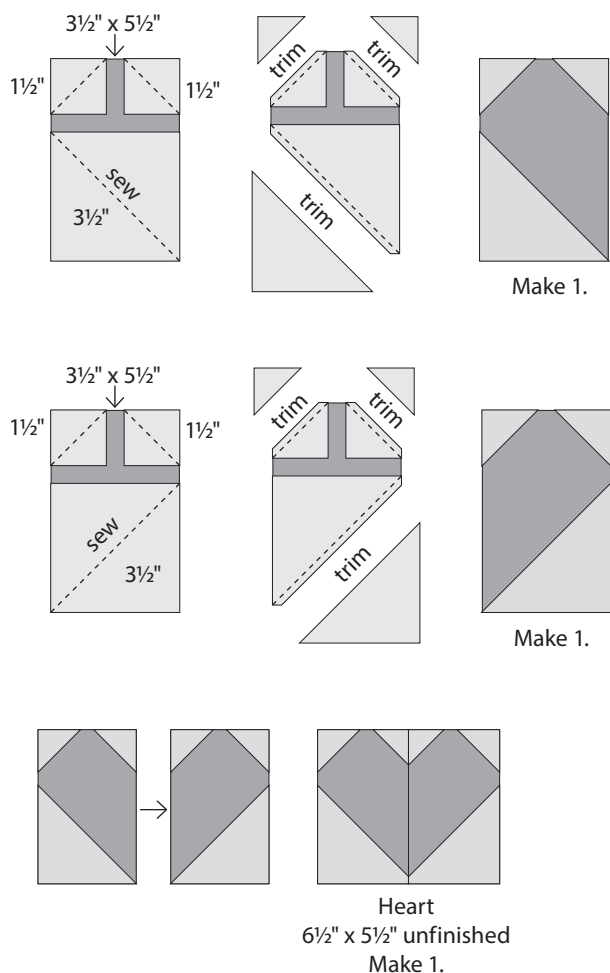

**3 House assembly** Assemble the heart house as shown. Use fusible web and a zig zag or blanket stitch to add the bird to the completed house block.

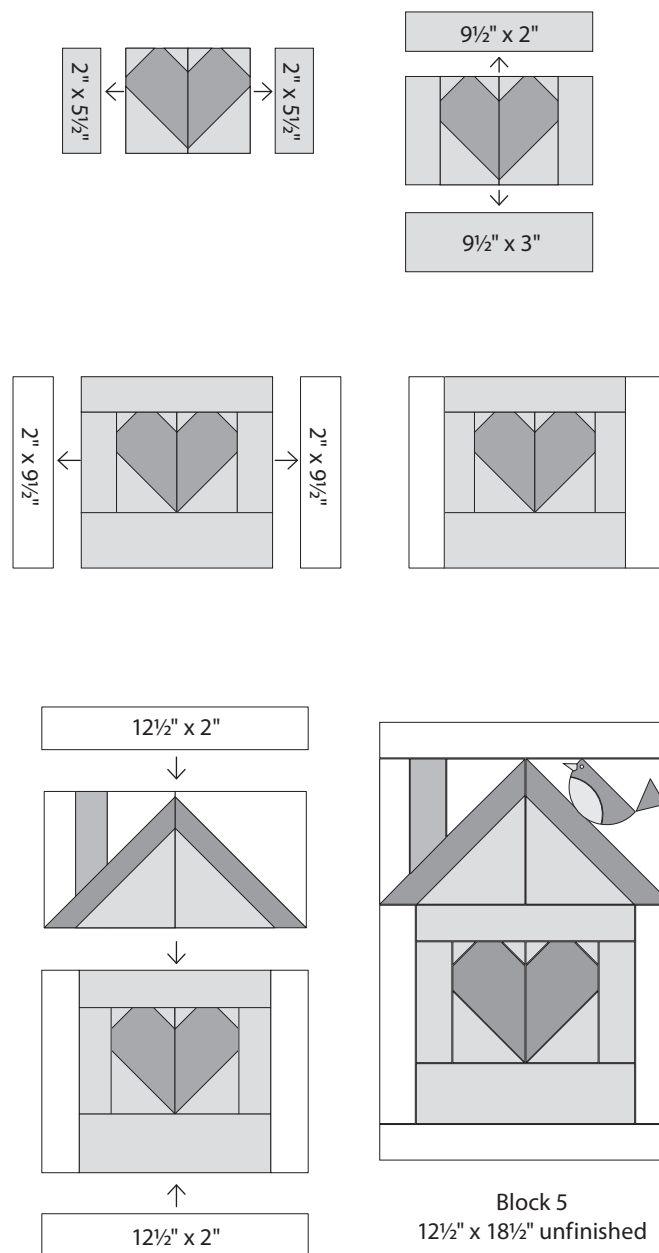

*moda*



*moda*

# Be My Neighbor

## Block 6

18" x 18" finished

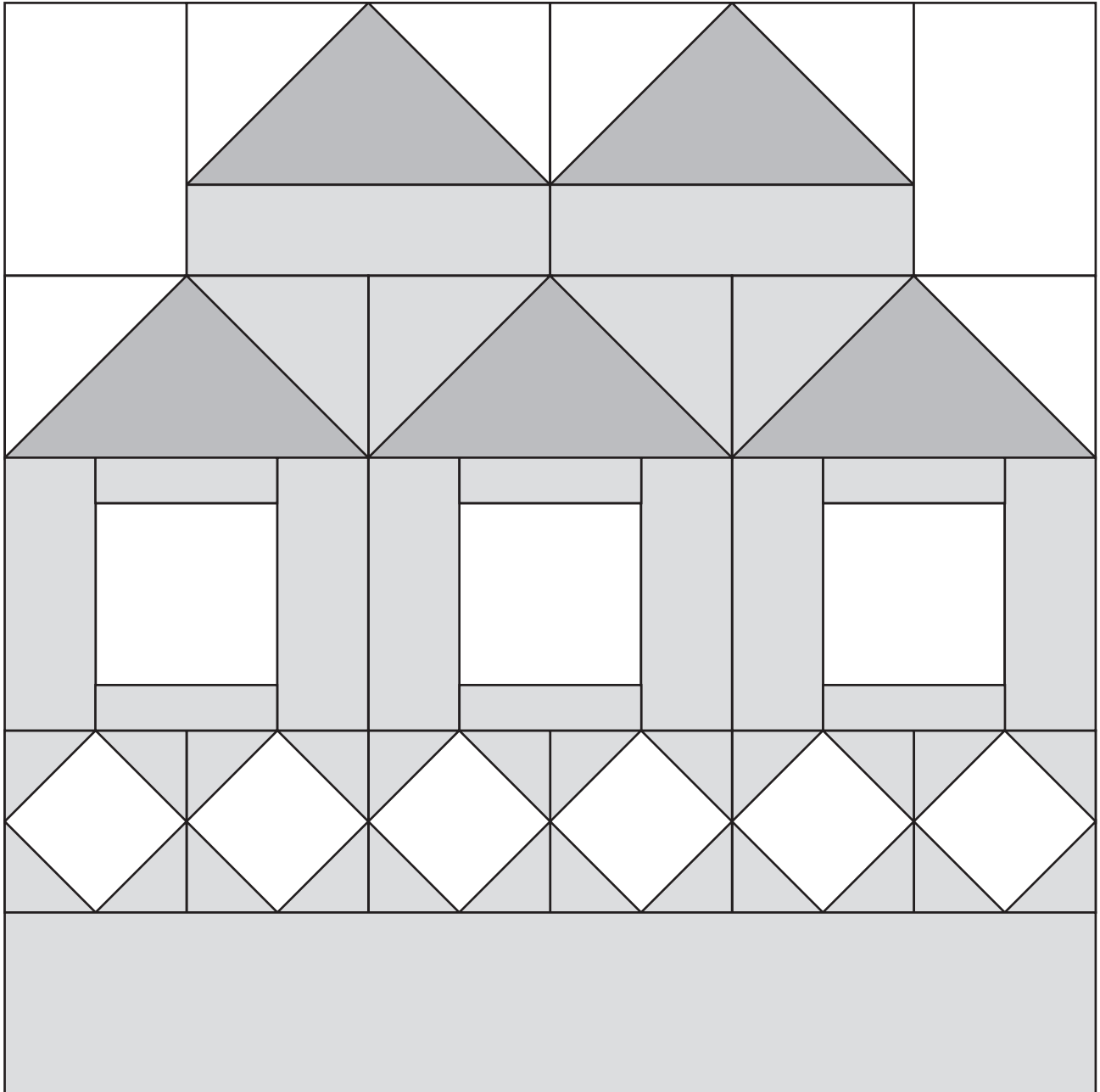

## General Information

- These are very scrappy blocks. Mix your favorite Moda prints to create your colorful neighborhood!
- Share your progress and final quilt at #BeMyNeighbor. We love to see your results!!!

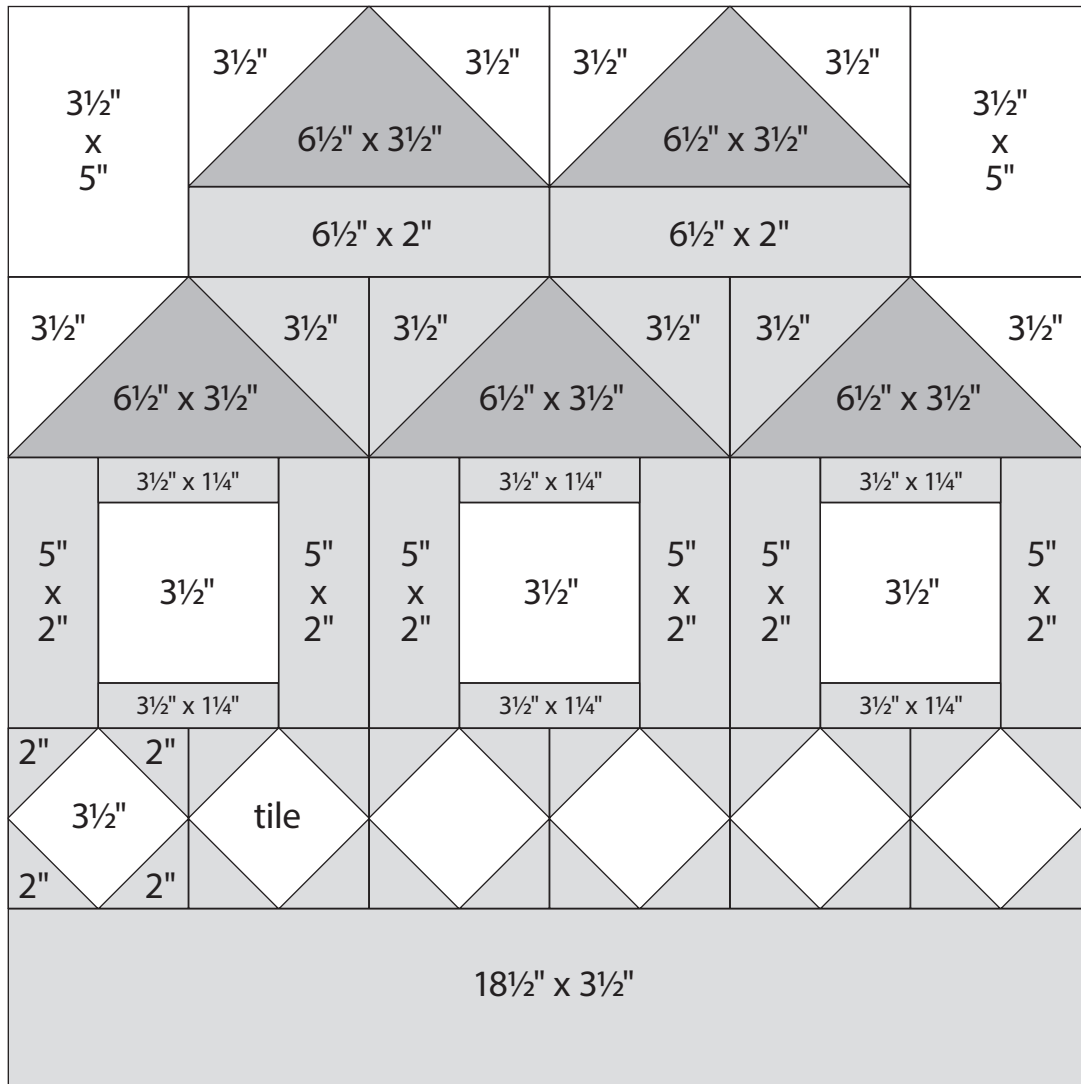

**Block 6**  
18½" x 18½" unfinished

## Cutting

### House Rooftops

5–6½" x 3½" rectangles

### Tiles

6–3½" squares

### Windows

3–3½" squares

### House

1–18½" x 3½" rectangle

2–6½" x 2" rectangles

6–5" x 2" rectangles

4–3½" squares

6–3½" x 1¼" rectangles

24–2" squares

### Background

2–3½" x 5" rectangles

6–3½" squares

# Be My Neighbor

Block 6 is 18" x 18" finished.

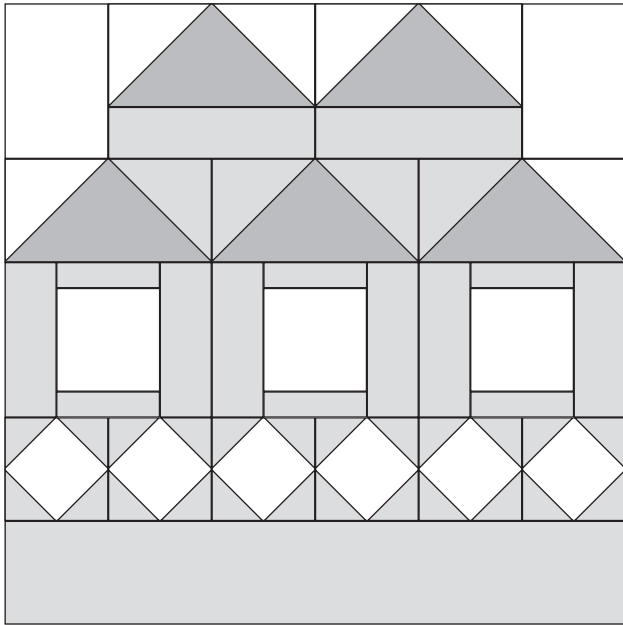

## Construction

Use  $\frac{1}{4}$ " seams. Press in the direction of the arrows in the diagrams.

### 1 House Rooftops A, B, C, and D

Draw a diagonal line from corner to corner on the wrong side of  $4-3\frac{1}{2}$ " house squares and  $6-3\frac{1}{2}$ " background squares.

The same technique is used to make all the roof tops. Just note whether you are using a marked house or marked background square. Layer a marked square, right sides to together, on  $1-6\frac{1}{2}$ " x  $3\frac{1}{2}$ " roof rectangle as shown. Sew on the diagonal line. Trim  $\frac{1}{4}$ " from the sewn line. Press to reveal the triangle. Repeat on the opposite end of the same rectangle.

#### House Roof A

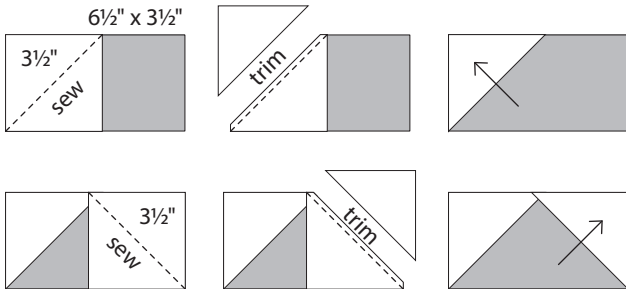

House Roof A  
 $6\frac{1}{2}$ " x  $3\frac{1}{2}$ " unfinished  
Make 2.

house roof tops continued . . .

#### House Roof B

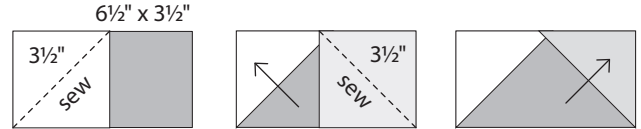

House Roof B  
 $6\frac{1}{2}$ " x  $3\frac{1}{2}$ " unfinished  
Make 1.

#### House Roof C

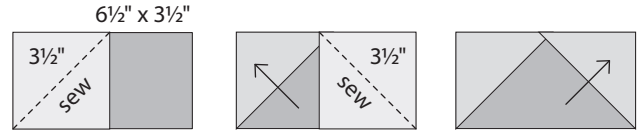

House Roof C  
 $6\frac{1}{2}$ " x  $3\frac{1}{2}$ " unfinished  
Make 1.

#### House Roof D

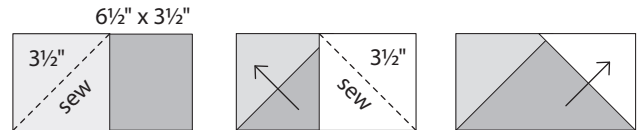

House Roof D  
 $6\frac{1}{2}$ " x  $3\frac{1}{2}$ " unfinished  
Make 1.

### 2 Assemble windows and rooftops as shown.

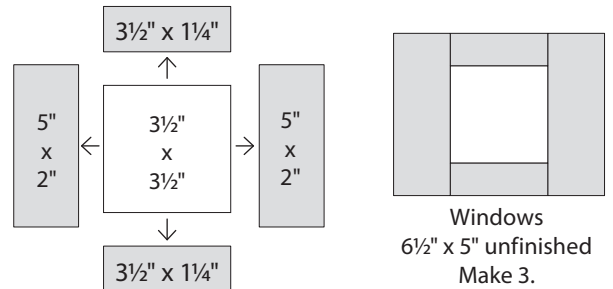

Windows  
 $6\frac{1}{2}$ " x 5" unfinished  
Make 3.

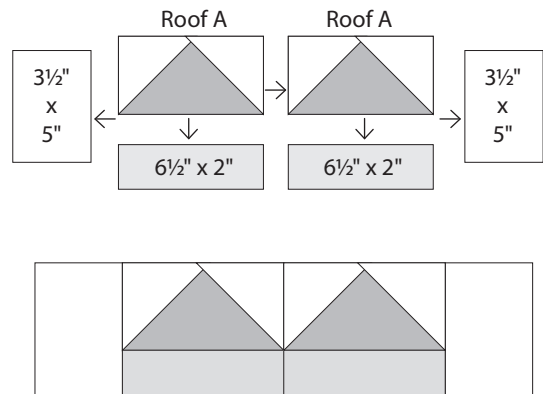

$18\frac{1}{2}$ " x 5" unfinished

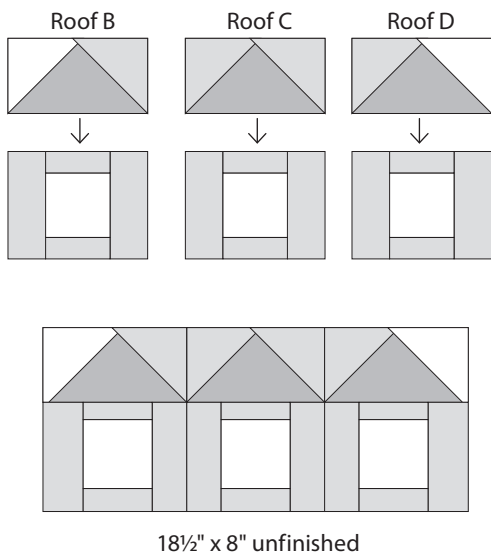

### 3 House Tiles

Draw a diagonal line from corner to corner on the wrong side of 24-2" house squares. Layer 2 marked squares on opposite corners of a 3" tile square, right sides to together. Sew on the diagonal lines. Trim 1/4" from the sewn line. Press to reveal the triangles. Repeat on the opposite ends of the same square. Make 6.

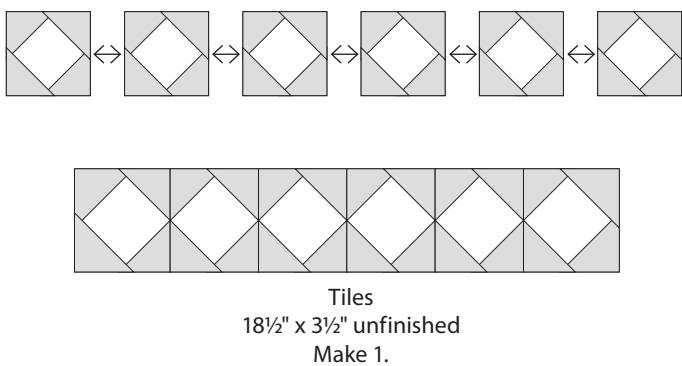
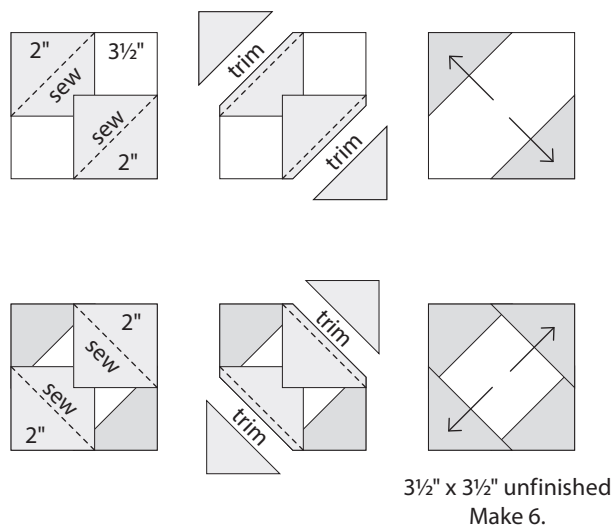

### 4 Assemble the block as shown.

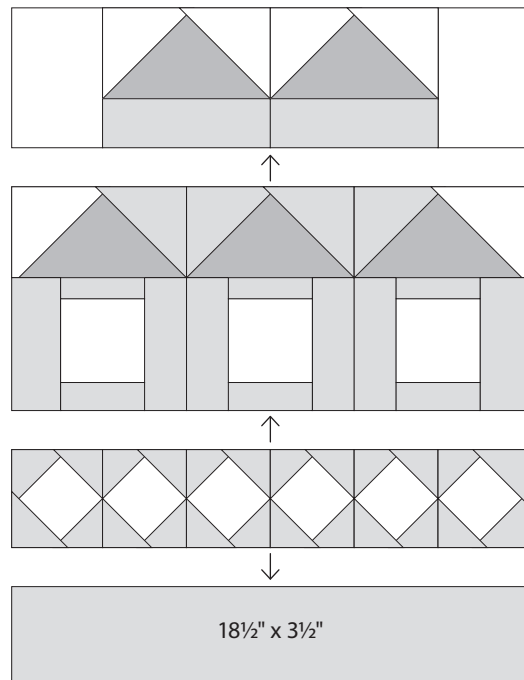

*moda*

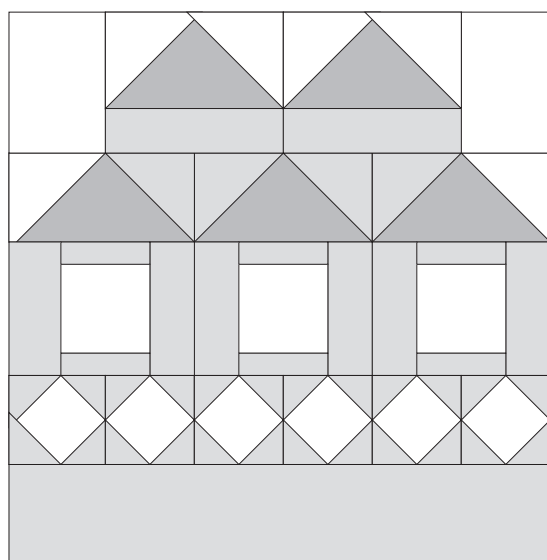

Block 6  
18 1/2" x 18 1/2" unfinished





*moda*

# Be My Neighbor

## Block 7

15" x 18" finished

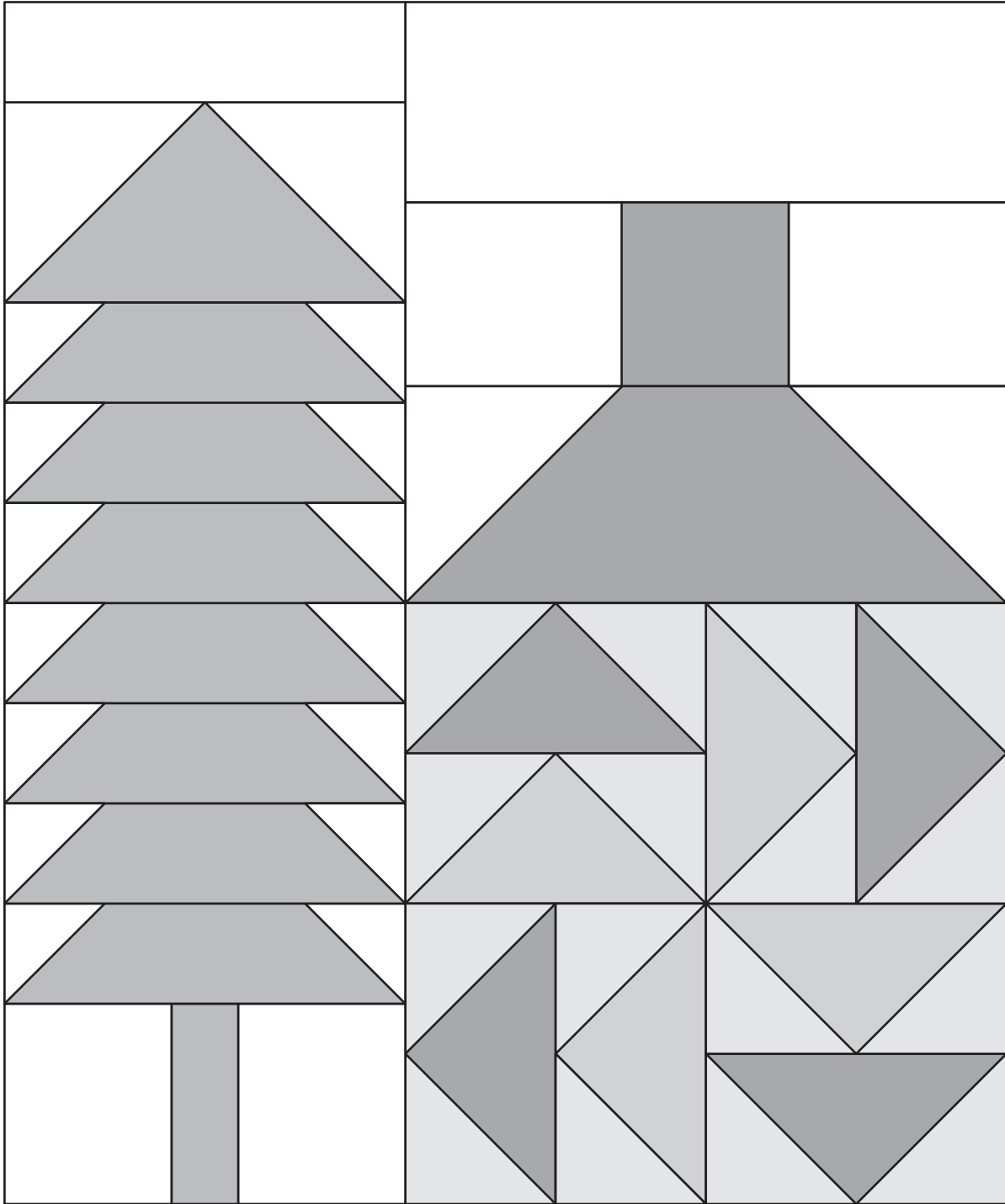

## General Information

- These are very scrappy blocks. Mix your favorite Moda prints to create your colorful neighborhood!
- Share your progress and final quilt at #BeMyNeighbor. We love to see your results!!!

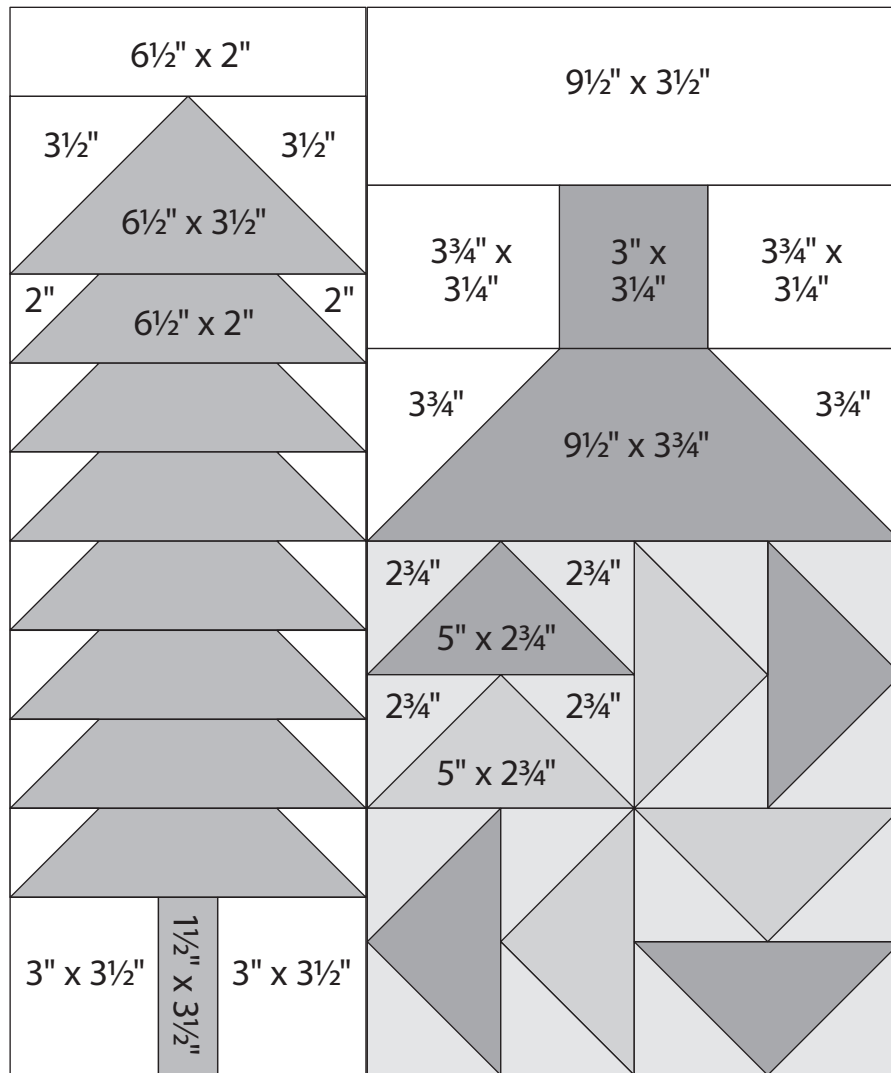

**Block 7**  
15 1/2" x 18 1/2" unfinished

## Cutting

### Tree

- 1-6 1/2" x 3 1/2" rectangle
- 7-6 1/2" x 2" rectangles

### Tree Trunk

- 1-1 1/2" x 3 1/2" rectangle

### House Roof and Chimney

- 1-9 1/2" x 3 3/4" rectangle
- 1-3" x 3 1/4" rectangle

### House

- 16-2 3/4" squares

### Flying Geese Dark

- 4-5" x 2 3/4" rectangles

### Flying Geese Medium

- 4-5" x 2 3/4" rectangles

### Background

- 1-9 1/2" x 3 1/2" rectangle
- 1-6 1/2" x 2" rectangle
- 2-3 3/4" squares
- 2-3 3/4" x 3 1/4" rectangles
- 2-3 1/2" squares
- 2-3" x 3 1/2" rectangles
- 14-2" squares



# moda Be My Neighbor

Block 7 is 15" x 18" finished.

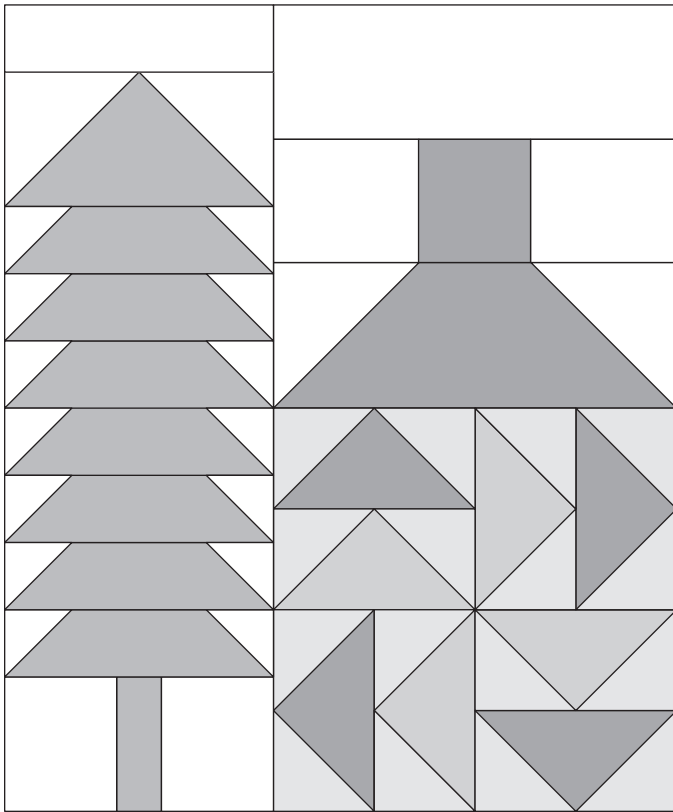

## Construction

Use  $\frac{1}{4}$ " seams. Press in the direction of the arrows in the diagrams.

### 1 House

- (A) Draw a diagonal line from corner to corner on the wrong side of  $2-3\frac{3}{4}$ " background squares. Layer a  $3\frac{3}{4}$ " marked background square, right sides to together, on both ends of a  $1-9\frac{1}{2}$ " x  $3\frac{3}{4}$ " roof rectangle as shown. Sew on the diagonal lines. Trim  $\frac{1}{4}$ " from the sewn lines. Press to reveal the triangles.

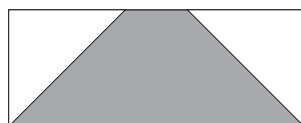
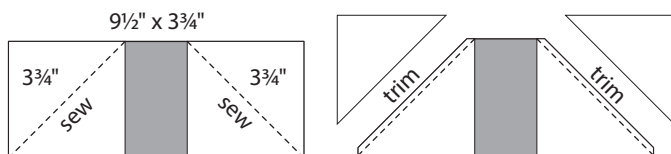

Roof  
 $9\frac{1}{2}$ " x  $3\frac{3}{4}$ " unfinished

House continued . . .

- (B) Draw a diagonal line from corner to corner on the wrong side of  $16-2\frac{3}{4}$ " house squares. Layer a  $2\frac{3}{4}$ " marked house square, right sides to together, on  $1-5$ " x  $2\frac{3}{4}$ " flying geese rectangle as shown. Sew on the diagonal line. Trim  $\frac{1}{4}$ " from the sewn line. Press to reveal the triangle. Repeat on the opposite end of the same rectangle. Make 4 dark and 4 medium.

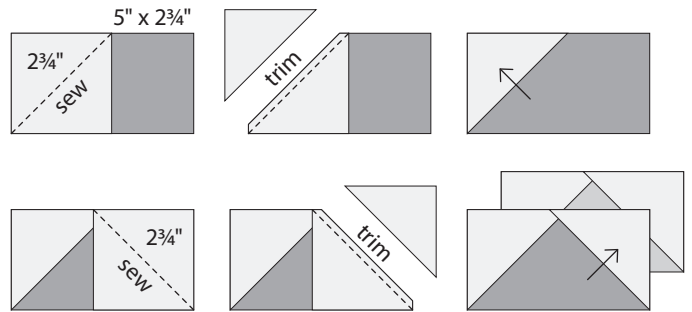

Flying Geese  
 $5$ " x  $2\frac{3}{4}$ " unfinished  
Make 4 dark and 4 medium.

- (C) Join 1 dark and medium flying geese as shown. Make 4.

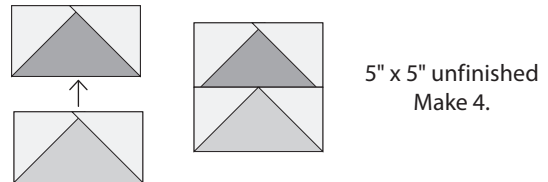

$5$ " x  $5$ " unfinished  
Make 4.

- (D) Assemble the house bottom.

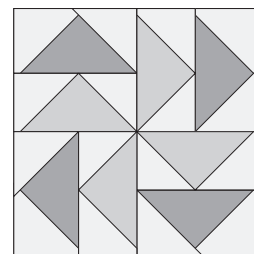
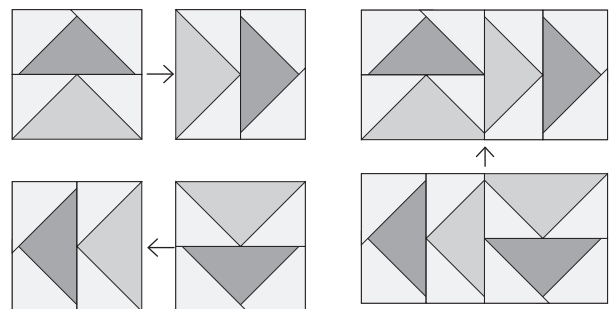

House Bottom  
 $9\frac{1}{2}$ " x  $9\frac{1}{2}$ " unfinished

moda

House continued . . .

(E) Assemble the house as shown.

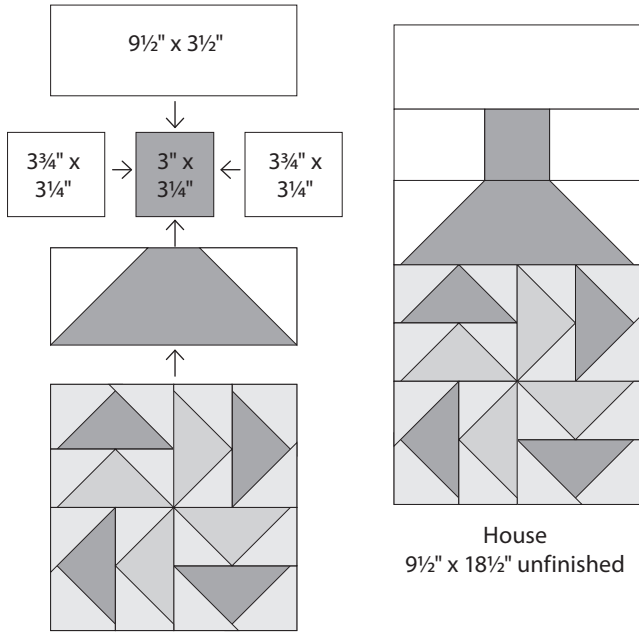

(C) Assemble the tree as shown.

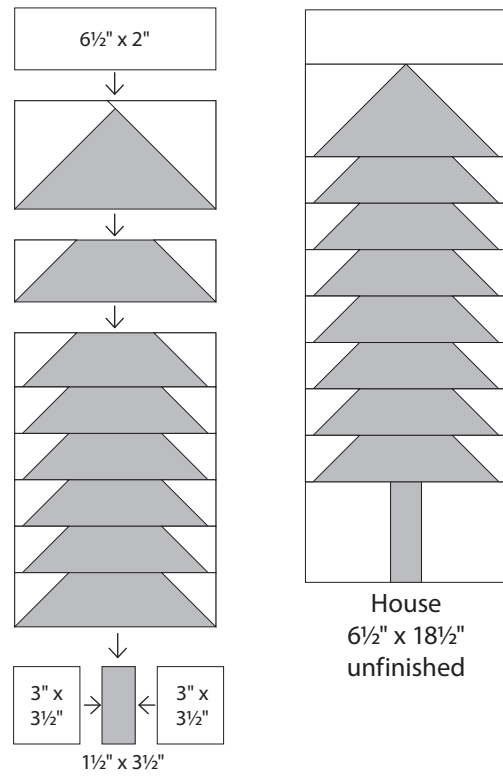

## 2 Tree

(A) Draw a diagonal line from corner to corner on the wrong side of 2–3 1/2" background squares. Layer a 3 1/2" marked background square, right sides to together, on 1–6 1/2" x 3 1/2" tree rectangle as shown. Sew on the diagonal line. Trim 1/4" from the sewn line. Press to reveal the triangle. Repeat on the opposite end of the same rectangle. Make 1.

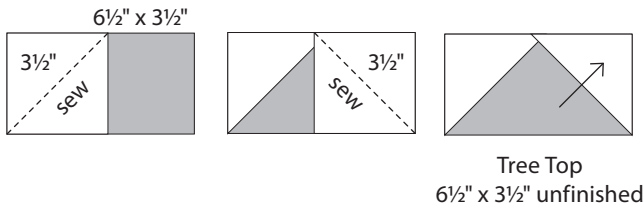

(B) Draw a diagonal line from corner to corner on the wrong side of 14–2" background squares. Layer 2" marked background square, right sides to together, on 1–6 1/2" x 2" tree rectangle as shown. Sew on the diagonal line. Trim 1/4" from the sewn line. Press to reveal the triangle. Repeat on the opposite end of the same rectangle. Make 7.

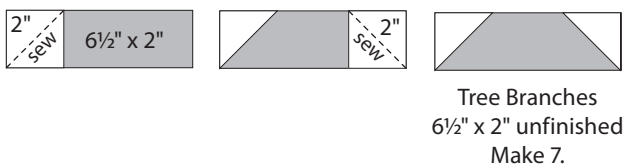

## 3 Assemble the block as shown.

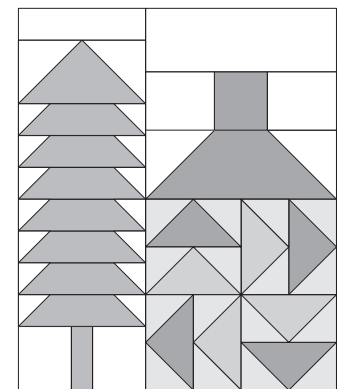
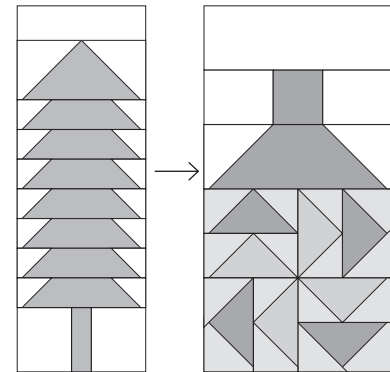

Block 7  
15 1/2" x 18 1/2" unfinished



*moda*

# Be My Neighbor

## Block 8

15" x 18" finished

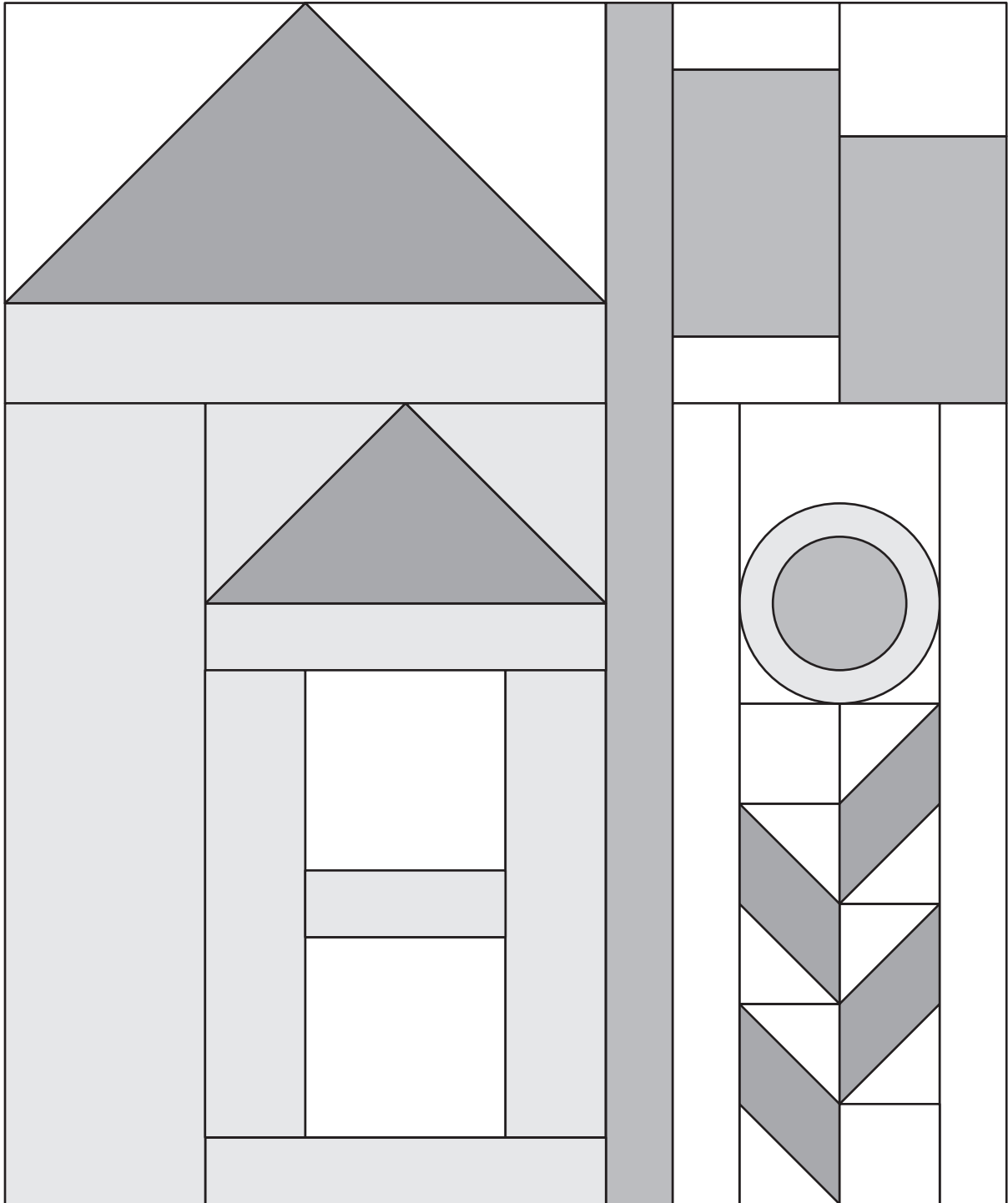

## General Information

- These are very scrappy blocks. Mix your favorite Moda prints to create your colorful neighborhood!
- Share your progress and final quilt at #BeMyNeighbor. We love to see your results!!!

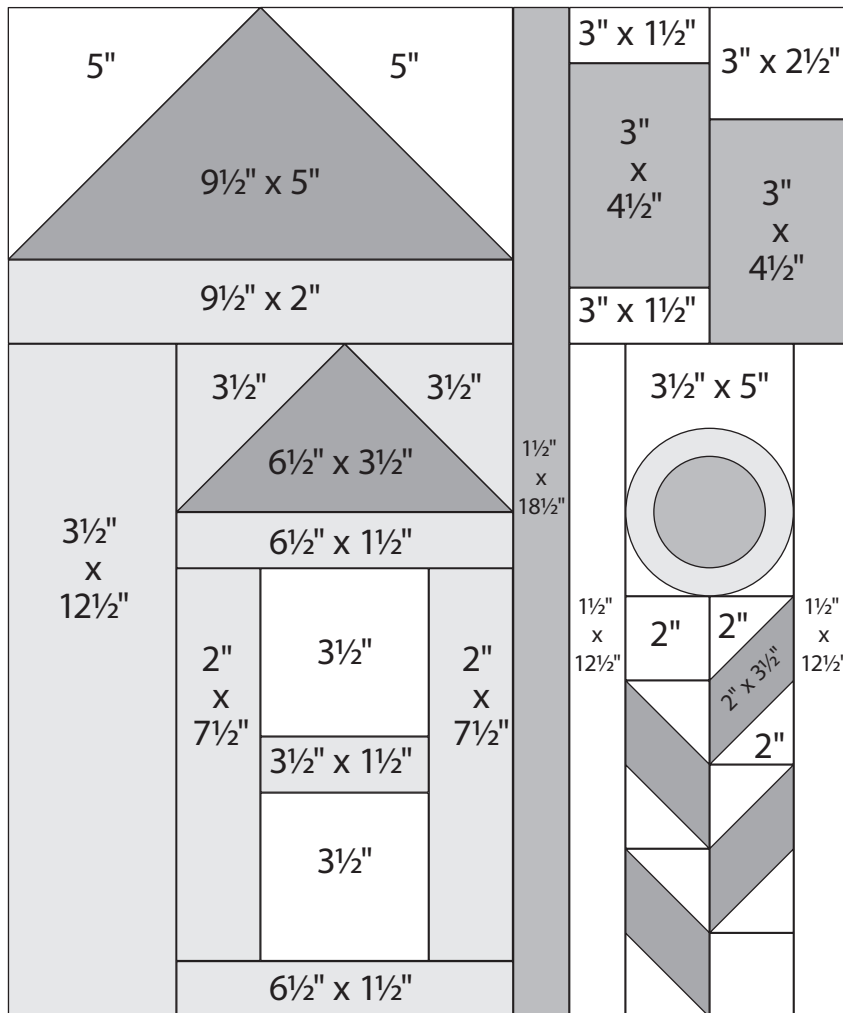

**Block 8**  
15½" x 18½" unfinished

## Cutting

### Leaves

4–2" x 3½" rectangles

### Flowers

2 circles

### Roof

1–9½" x 5" rectangle

1–6½" x 3½" rectangle

### Flag

2–3" x 4½" rectangles

### Flag Pole

1–1½" x 18½" rectangle

### Window

2–3½" squares

### House

1–9½" x 2" rectangle

2–6½" x 1½" rectangles

1–3½" x 12½" rectangle

1–3½" x 1½" rectangle

2–3½" squares

2–2" x 7½" rectangles

### Background

2–5" squares

1–3½" x 5" rectangle

2–3" x 1½" rectangles

1–3" x 2½" rectangle

10–2" squares

2–1½" x 12½" rectangles



# moda Be My Neighbor

Block 8 is 15" x 18" finished.

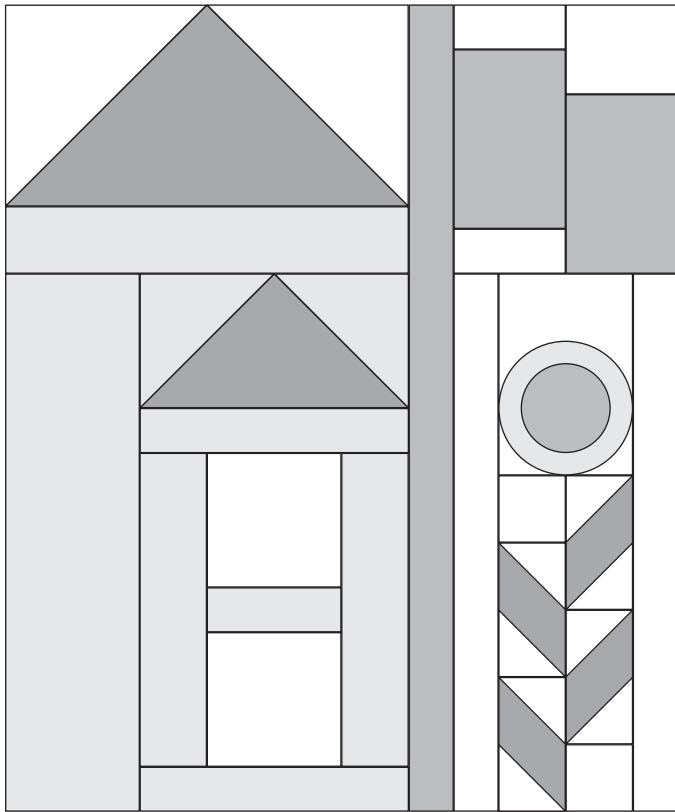

- 2 House Roof Small**  
 Draw a diagonal line from corner to corner on the wrong side of 2-3½" house squares. Layer a 3½" marked house square, right sides to together, on 1-6½" x 3½" small roof rectangle as shown. Sew, trim, and press. Repeat on the the opposite end of the same rectangle. Make 1.

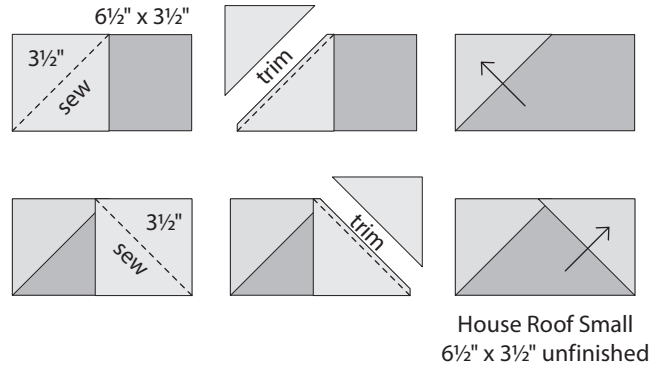

- 3** Assemble the house as shown.

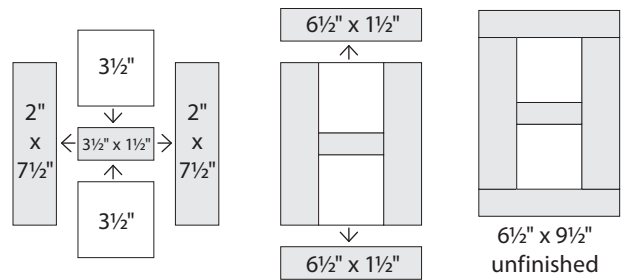

## Construction

Use ¼" seams. Press in the direction of the arrows in the diagrams.

- 1 House Roof Large**  
 Draw a diagonal line from corner to corner on the wrong side of 2-5" background squares. Layer a 5" marked background square, right sides to together, on 1-9½" x 5" roof rectangle as shown. Sew on the diagonal line. Trim ¼" from the sewn line. Press to reveal the triangle. Repeat on the the opposite end of the same rectangle. Make 1.

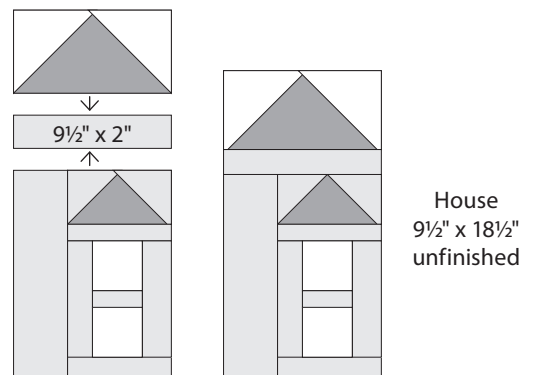
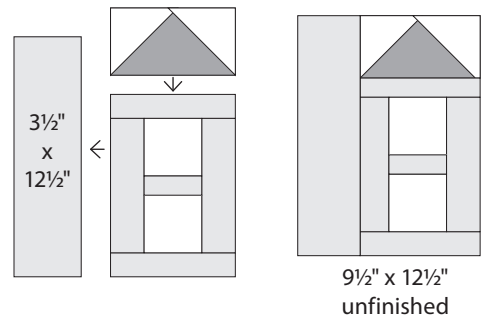
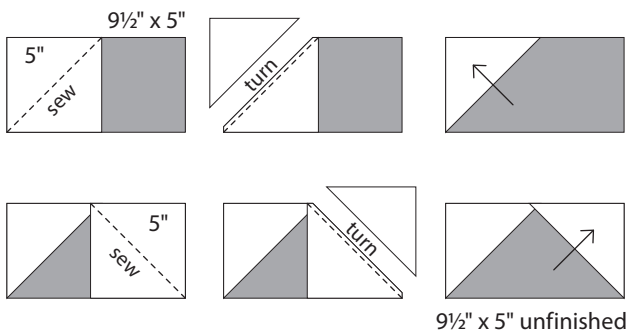

# 4 Flower

(A) Draw a diagonal line from corner to corner on the wrong side of 8-2" background squares. Layer a 2" marked background square, right sides to together, on 1-2" x 3 1/2" leaf rectangle as shown. Sew on the diagonal line. Trim 1/4" from the sewn line. Press to reveal the triangle. Repeat on the the opposite end of the same rectangle. Make 2 leaf As and 2 leaf Bs. *Note the 2" square placement is different.*

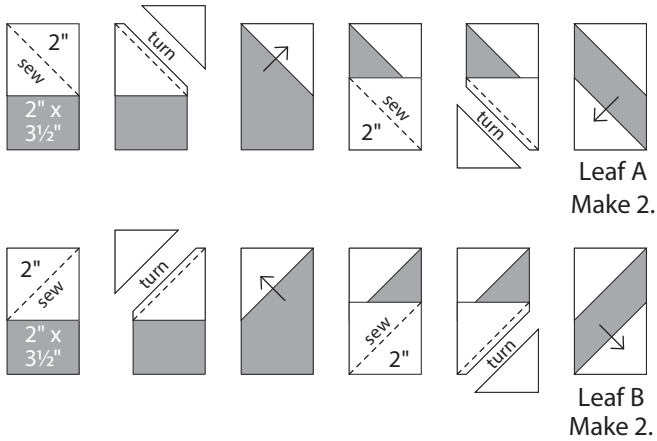

(B) Arrange and sew 2-Leaf As and 1-2" background square to make column A. Arrange sew 1-2" background square and sew 2-Leaf Bs to make column B. Join the columns, add a 3 1/2" x 5" background rectangle. Add 2-1 1/2" x 12 1/2" background rectangles. Use you appliqué method of choice to add the circles.

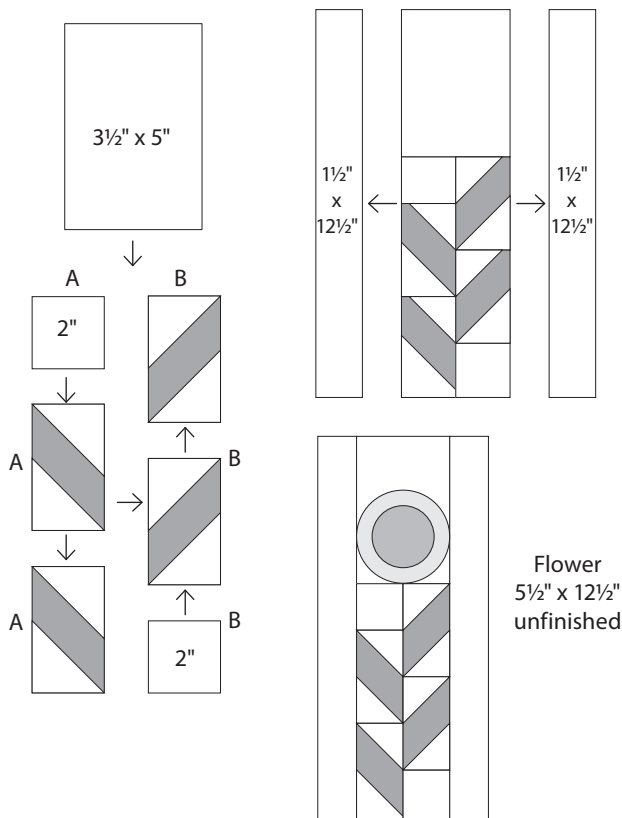

# 5 Assemble the flag as shown.

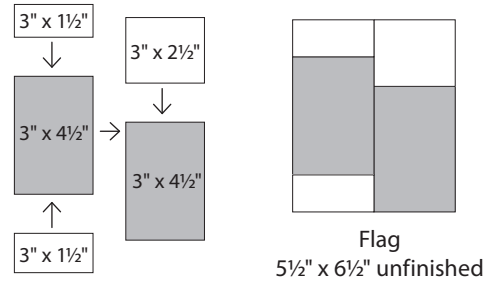

moda

# 6 Assemble the block as shown.

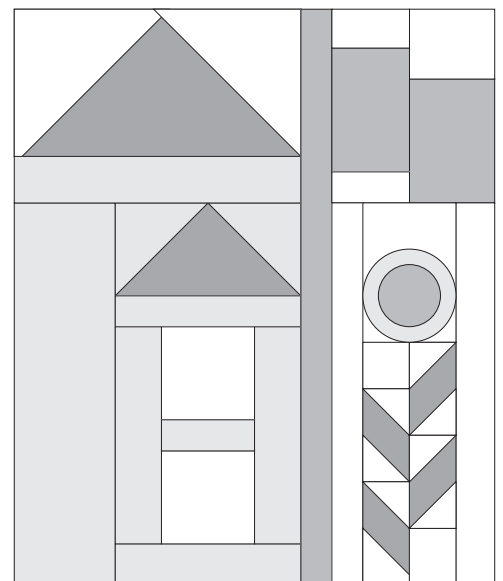
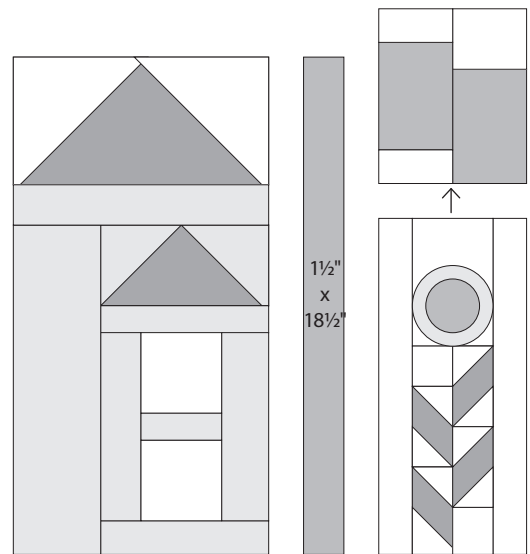





*moda*

# Be My Neighbor

**Block 9**  
15" x 18" finished

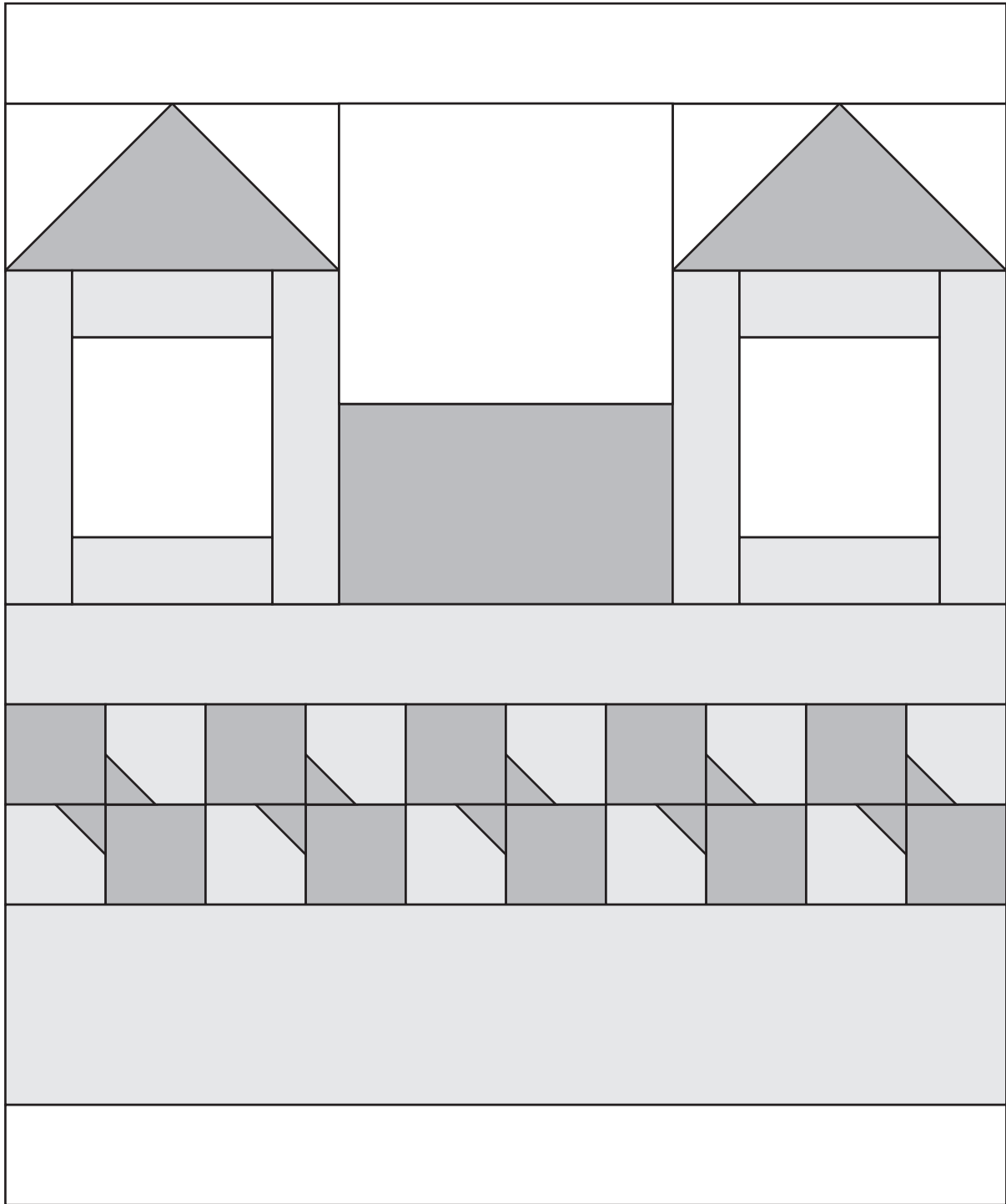

## General Information

- These are very scrappy blocks. Mix your favorite Moda prints to create your colorful neighborhood!
- Share your progress and final quilt at #BeMyNeighbor. We love to see your results!!!

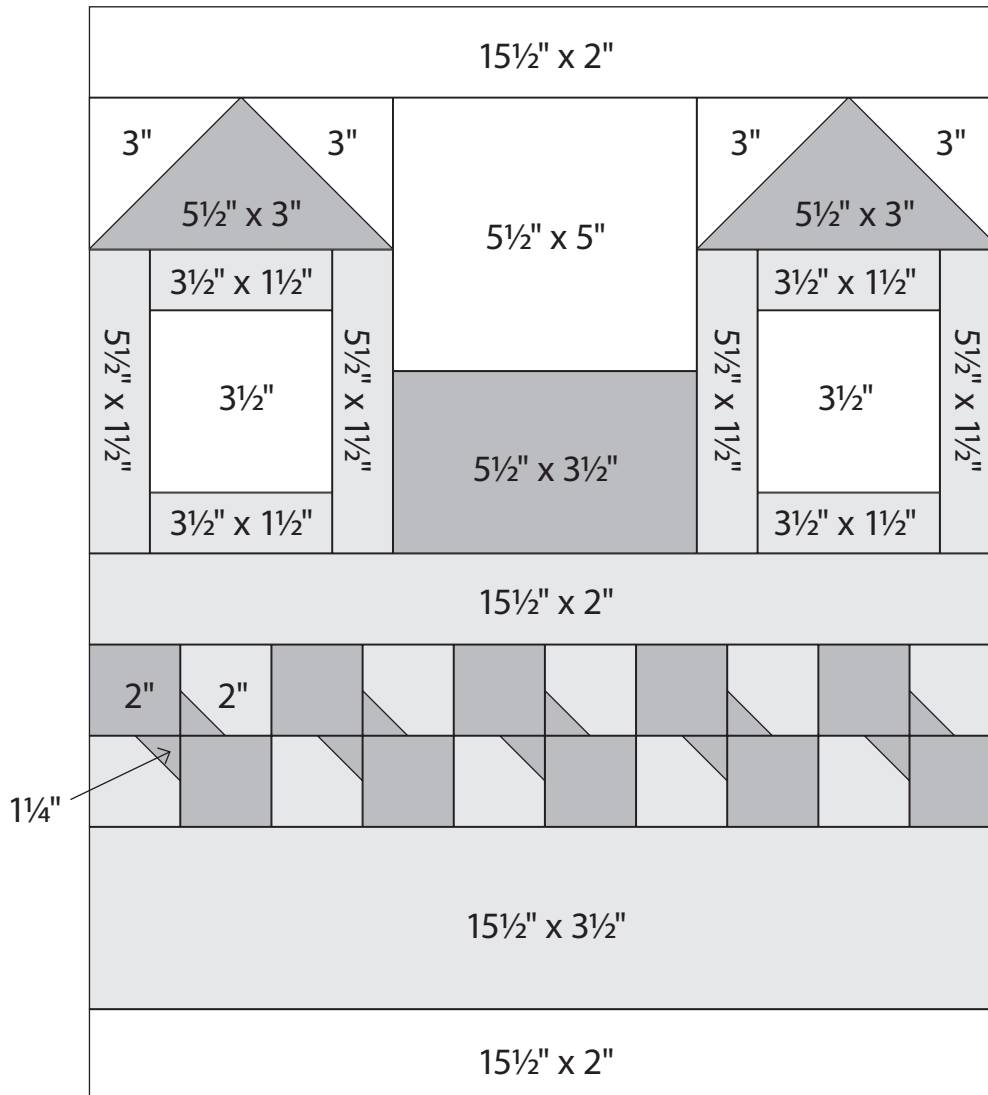

**Block 9**  
15 1/2" x 18 1/2" unfinished

## Cutting

### House Roof

- 1-5 1/2" x 3 1/2" rectangle
- 2-5 1/2" x 3" rectangles

### Bowties (5 total)

- For EACH bowtie cut
- 2-2" squares and 2-1/4" squares

### Windows

- 2-3 1/2" squares

### House

- 1-15 1/2" x 3 1/2" rectangle
- 1-15 1/2" x 2" rectangle
- 10-2" squares
- 4-5 1/2" x 1 1/2" rectangles
- 4-3 1/2" x 1 1/2" rectangles

### Background

- 2-15 1/2" x 2" rectangles
- 1-5 1/2" x 5" rectangles
- 4-3" squares

# Be My Neighbor

Block 9 is 15" x 18" finished.

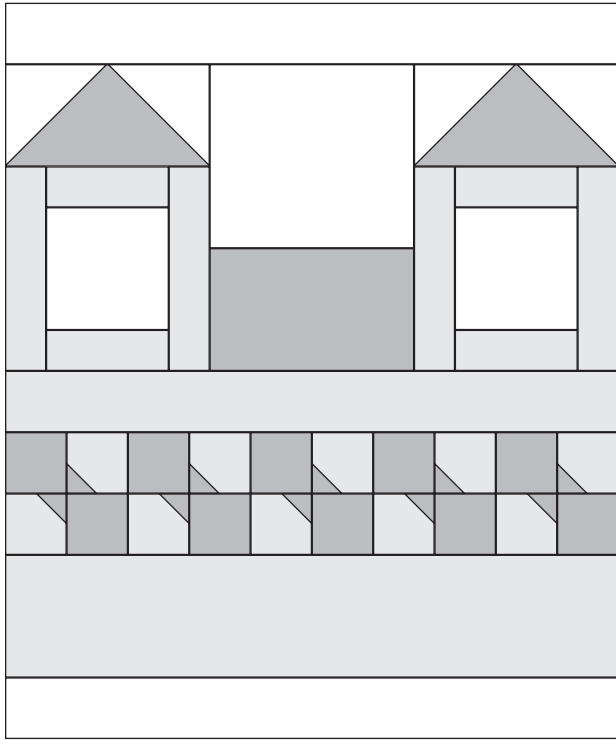

House Rooftops and Windows continued . . .

(B) Assemble windows and rooftops as shown.

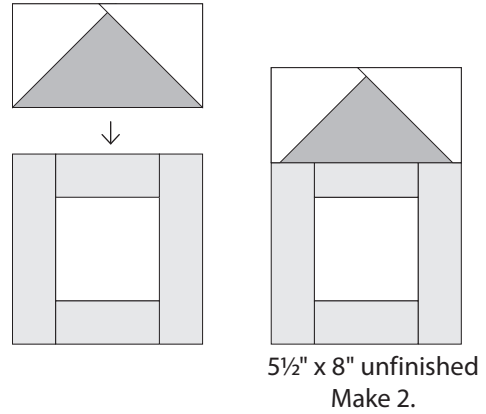
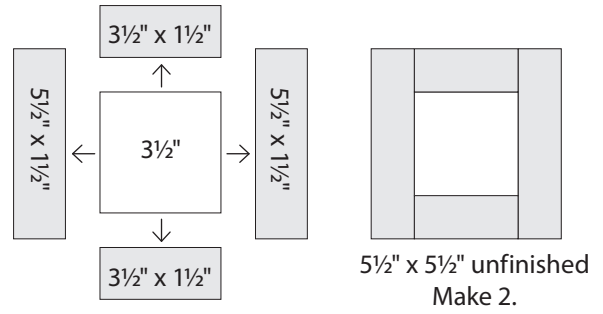

## Construction

Use 1/4" seams. Press in the direction of the arrows in the diagrams.

### 1 House Rooftops and Windows

(A) Draw a diagonal line from corner to corner on the wrong side of 4-3" background squares. Layer a 3" marked background square, right sides to together, on 1-5 1/2" x 3" roof rectangle as shown. Sew on the diagonal line. Trim 1/4" from the sewn line. Press to reveal the triangle. Repeat on the opposite end of the same rectangle. Make 2.

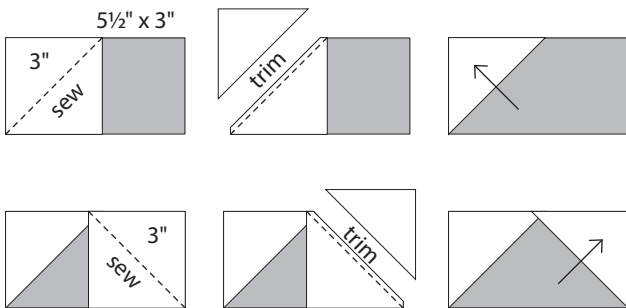

House  
5 1/2" x 3" unfinished  
Make 2.

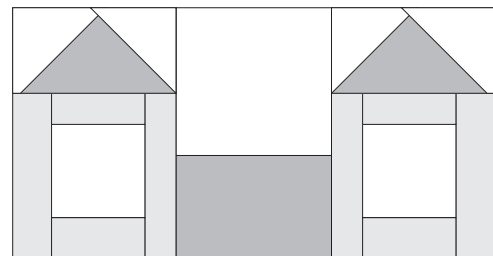
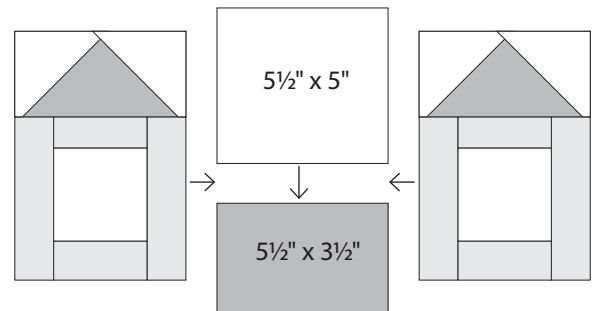

15 1/2" x 8" unfinished

## 2 To make one Bowtie

(A) Draw a diagonal line from corner to corner on the wrong side of 2-1¼" bowtie squares. Layer a 1¼" marked bowtie square, right sides together, on 1-2" house square as shown. Sew on the diagonal line. Trim ¼" from the sewn line. Press to reveal the triangle.

Make 2.

Arrange and sew 2 rows of 1-2" bowtie square and 1 bowtie as shown. Join the rows. Repeat to make bowties.

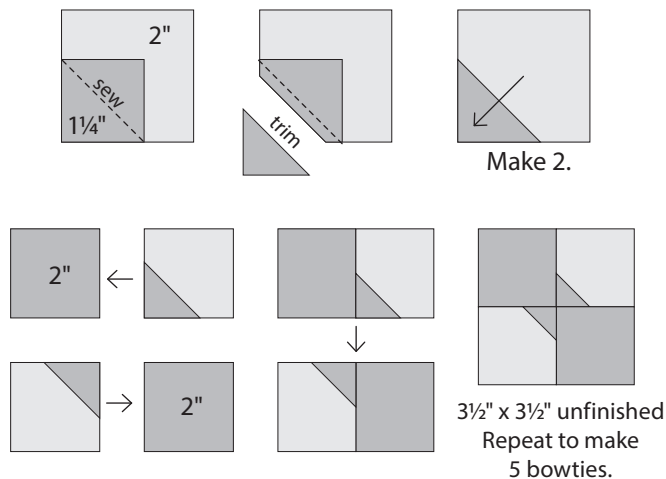

(B) Join the 5 bowties in one row.

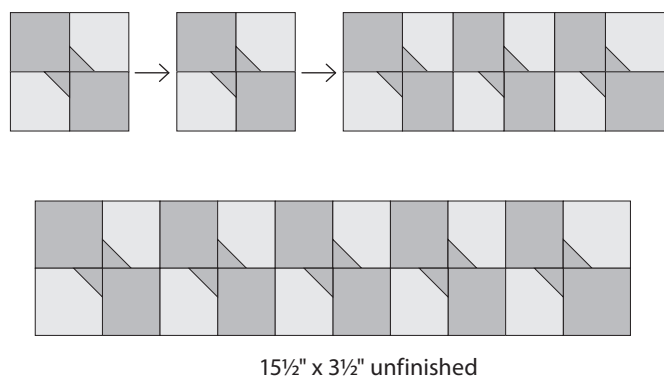

*moda*

## 3 Assemble the block as shown.

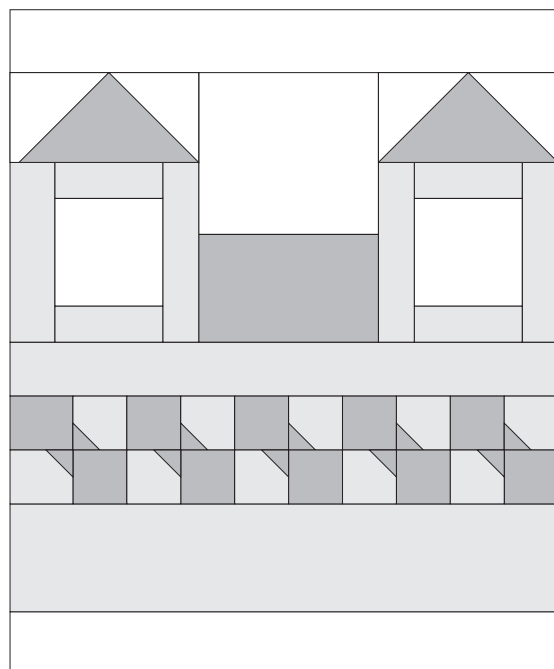
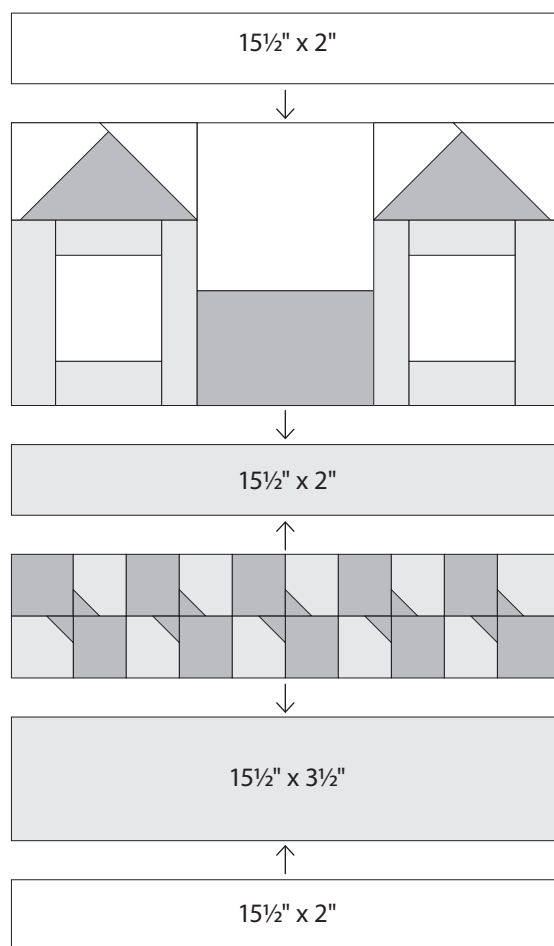

Block 9  
15½" x 18½" unfinished



*moda*

# Be My Neighbor

## Block 10

15" x 18" finished

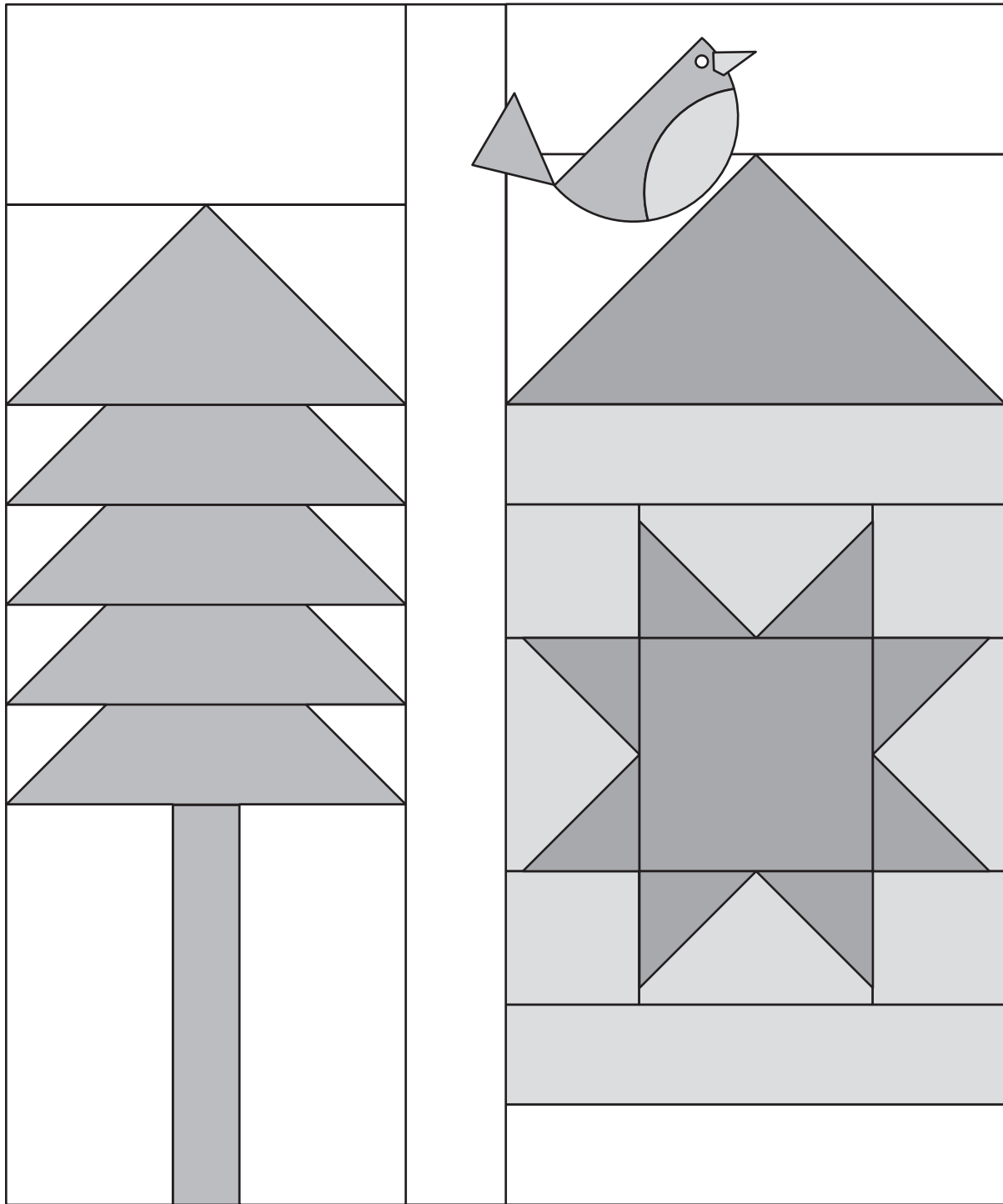

## General Information

- These are very scrappy blocks. Mix your favorite Moda prints to create your colorful neighborhood!
- Share your progress and final quilt at #BeMyNeighbor. We love to see your results!!!

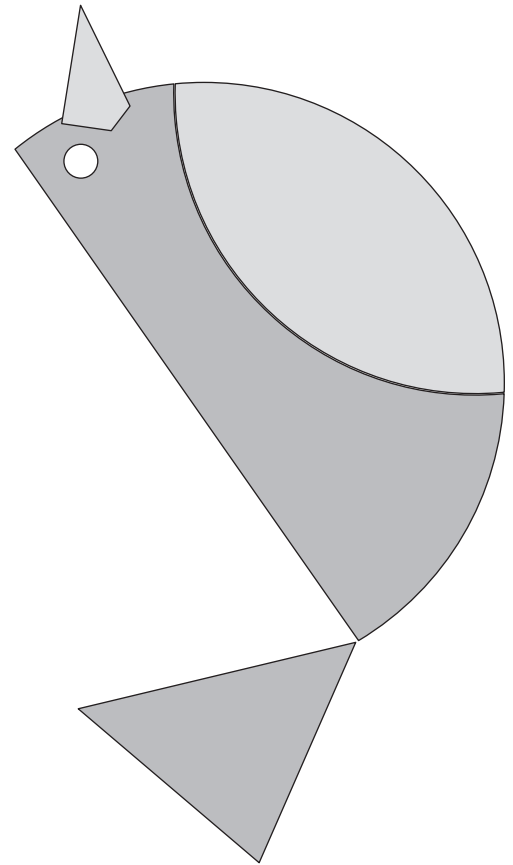
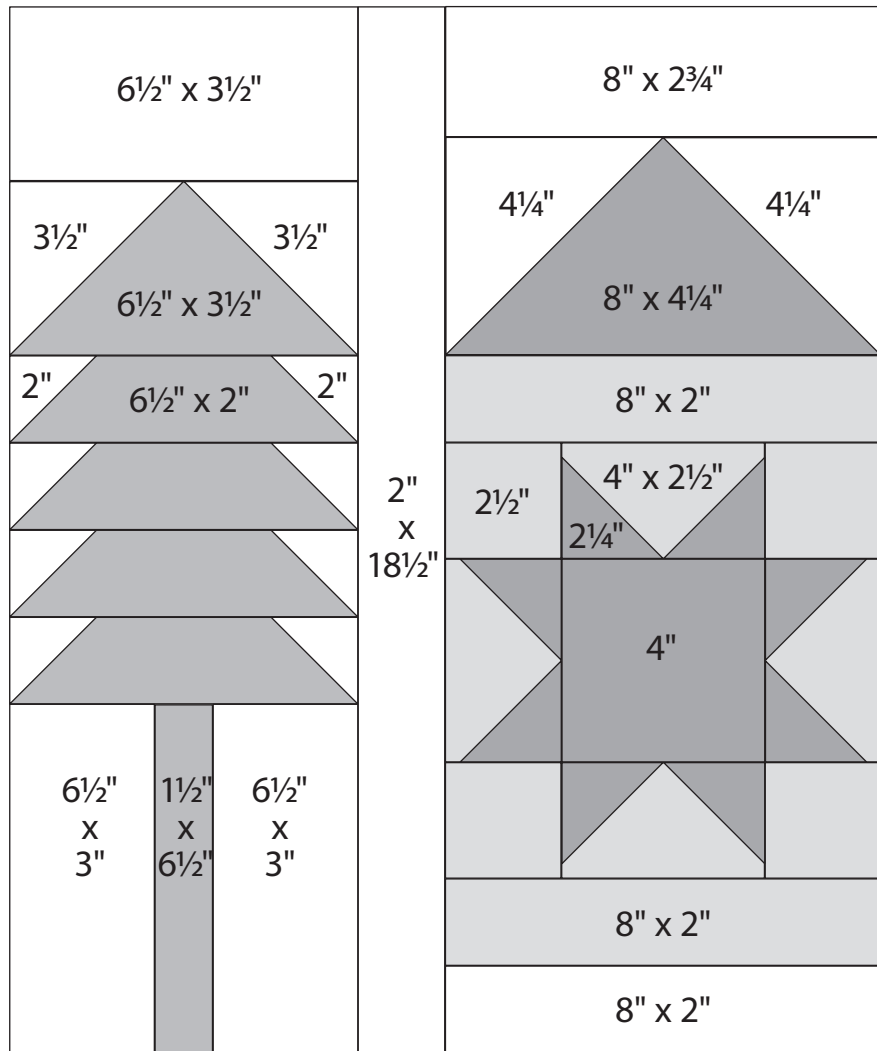

**Bird Appliqué**  
Actual size.  
Seam allowances not included.  
Not reversed.

**Block 10**  
15 1/2" x 18 1/2" unfinished

## Cutting

### Tree

1-6 1/2" x 3 1/2" rectangle  
4-6 1/2" x 2" rectangles

### Tree Trunk

1-1 1/2" x 6 1/2" rectangle

### Star

1-4" square  
8-2 1/4" squares

### House Roof

1-8" x 4 1/4" rectangle

### House

2-8" x 2" rectangles  
4-4" x 2 1/2" rectangles  
4-2 1/2" squares

### Bird Appliqué

1-beak  
1-body  
1-tail  
1-wing  
1-eye

### Background

1-8" x 2 3/4" rectangle  
1-8" x 2" rectangle  
1-6 1/2" x 3 1/2" rectangle  
2-4 1/4" squares  
2-3 1/2" squares  
2-3" x 6 1/2" rectangles  
1-2" x 18 1/2" rectangle  
8-2 squares



# Be My Neighbor

Block 10 is 15" x 18" finished.

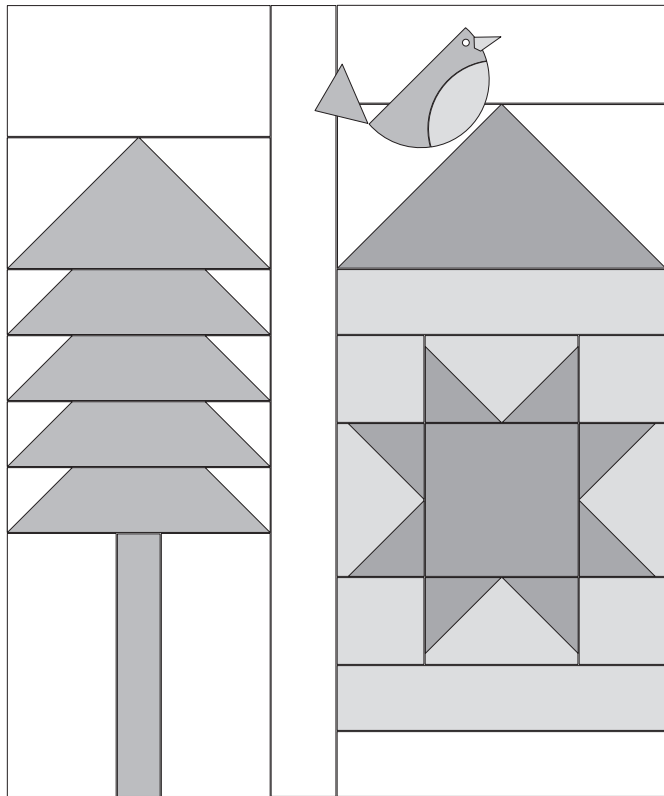

## Construction

Use  $\frac{1}{4}$ " seams. Press in the direction of the arrows in the diagrams.

### 1 Tree

- (A) Draw a diagonal line from corner to corner on the wrong side of 2- $\frac{3}{2}$ " background squares. Layer a 3- $\frac{1}{2}$ " marked background square, right sides to together, on 1-6- $\frac{1}{2}$ " x 3- $\frac{1}{2}$ " tree rectangle as shown. Sew on the diagonal line. Trim  $\frac{1}{4}$ " from the sewn line. Press to reveal the triangle. Repeat on the opposite end of the same rectangle. Make 1.

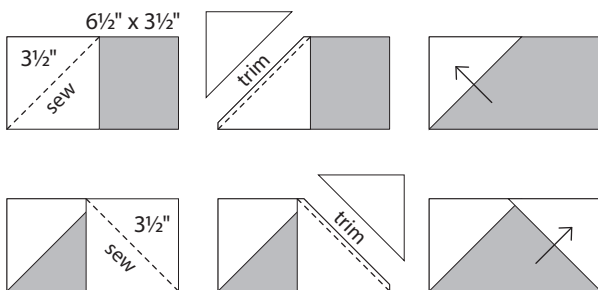

Tree Top  
6- $\frac{1}{2}$ " x 3- $\frac{1}{2}$ " unfinished

tree continued . . .

- (B) Draw a diagonal line from corner to corner on the wrong side of 8-2" background squares. Layer a 2" marked background square, right sides to together, on both ends of a 1-6- $\frac{1}{2}$ " x 2" tree rectangle as shown. Sew on the diagonal lines. Trim  $\frac{1}{4}$ " from the sewn lines. Press to reveal the triangles. Make 4.

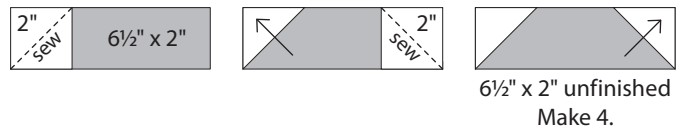

- (C) Assemble the tree as shown.

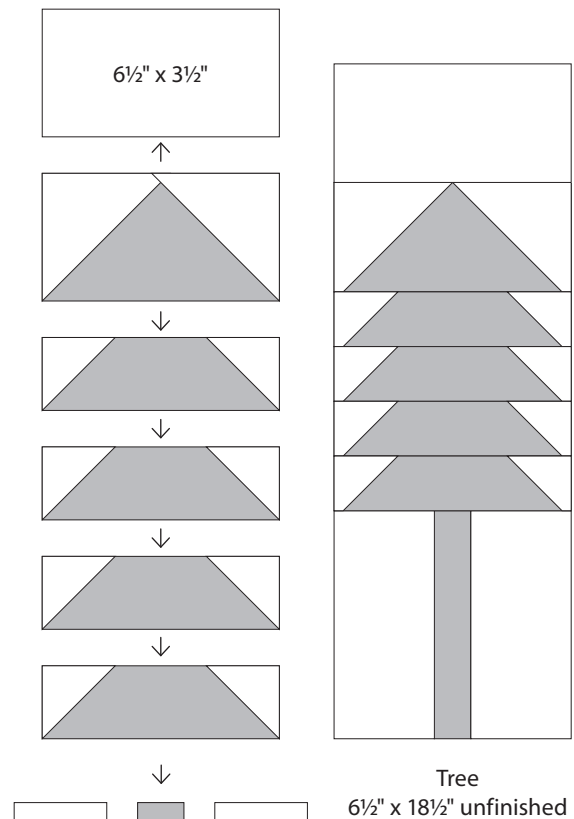

moda

## 2 House

(A) Draw a diagonal line from corner to corner on the wrong side of 2-4 1/4" background squares. Layer a 4 1/4" marked background square, right sides to together, on 1-8" x 4 1/4" roof rectangle as shown. Sew on the diagonal line. Trim 1/4" from the sewn line. Press to reveal the triangle. Repeat on the opposite end of the same rectangle. Make 1.

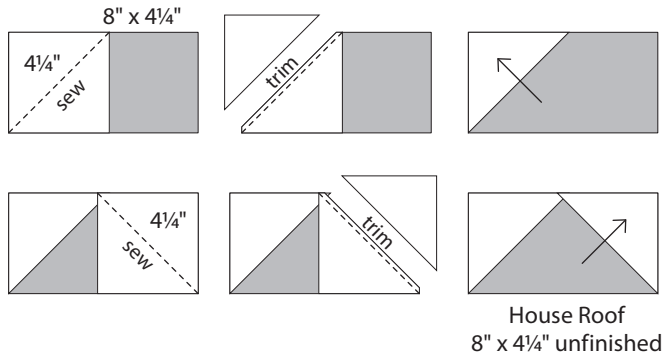

(B) Draw a diagonal line from corner to corner on the wrong side of 8-2 1/4" star point squares. Layer 2 1/4" marked star point square, right sides to together, on 1-4" x 2 1/2" house rectangle as shown. Sew on the diagonal line. Trim 1/4" from the sewn line. Press to reveal the triangle. Repeat on the opposite end of the same rectangle. Make 4 star points.

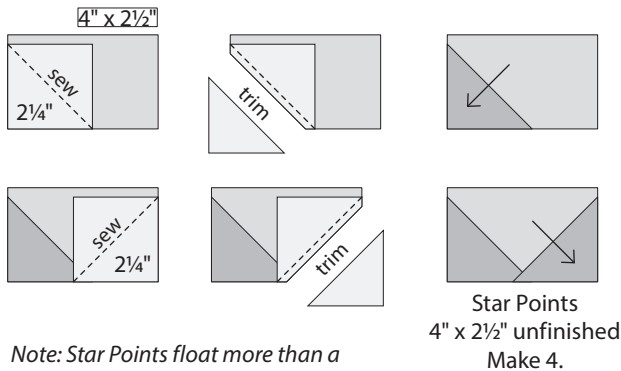

*Note: Star Points float more than a 1/4" from the edges.*

(C) Assemble the star as shown.

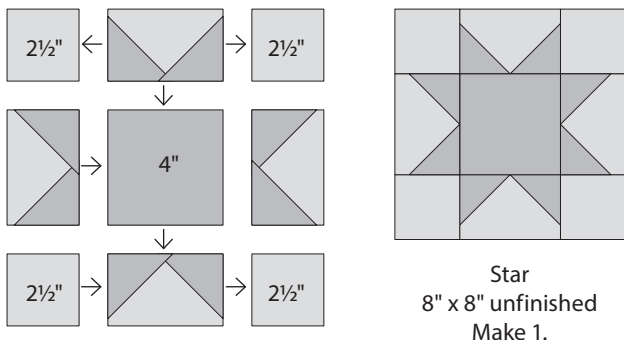

3 Assemble the block as shown. Use fusible web and a zig zag or blanket stitch to add the bird to the completed house block.

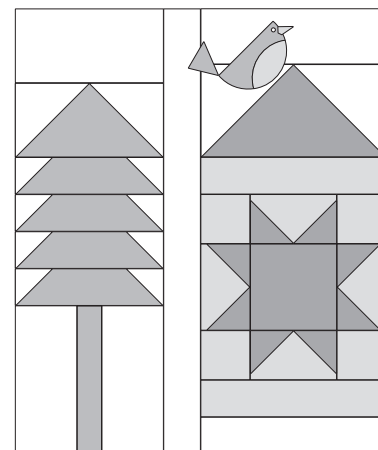
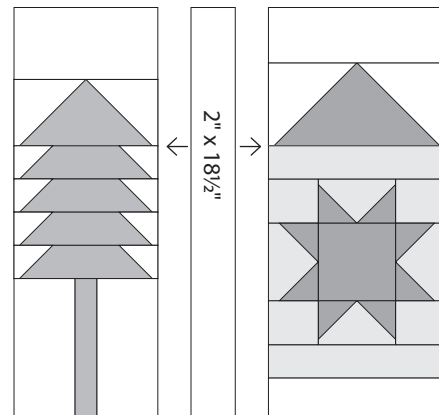
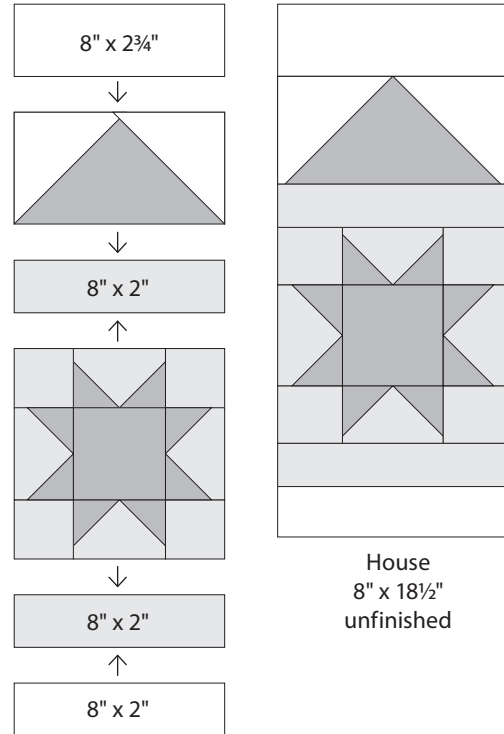

**Block 10**  
15 1/2" x 18 1/2" unfinished





*moda*

# Be My Neighbor

## Block 11

21" x 18" finished

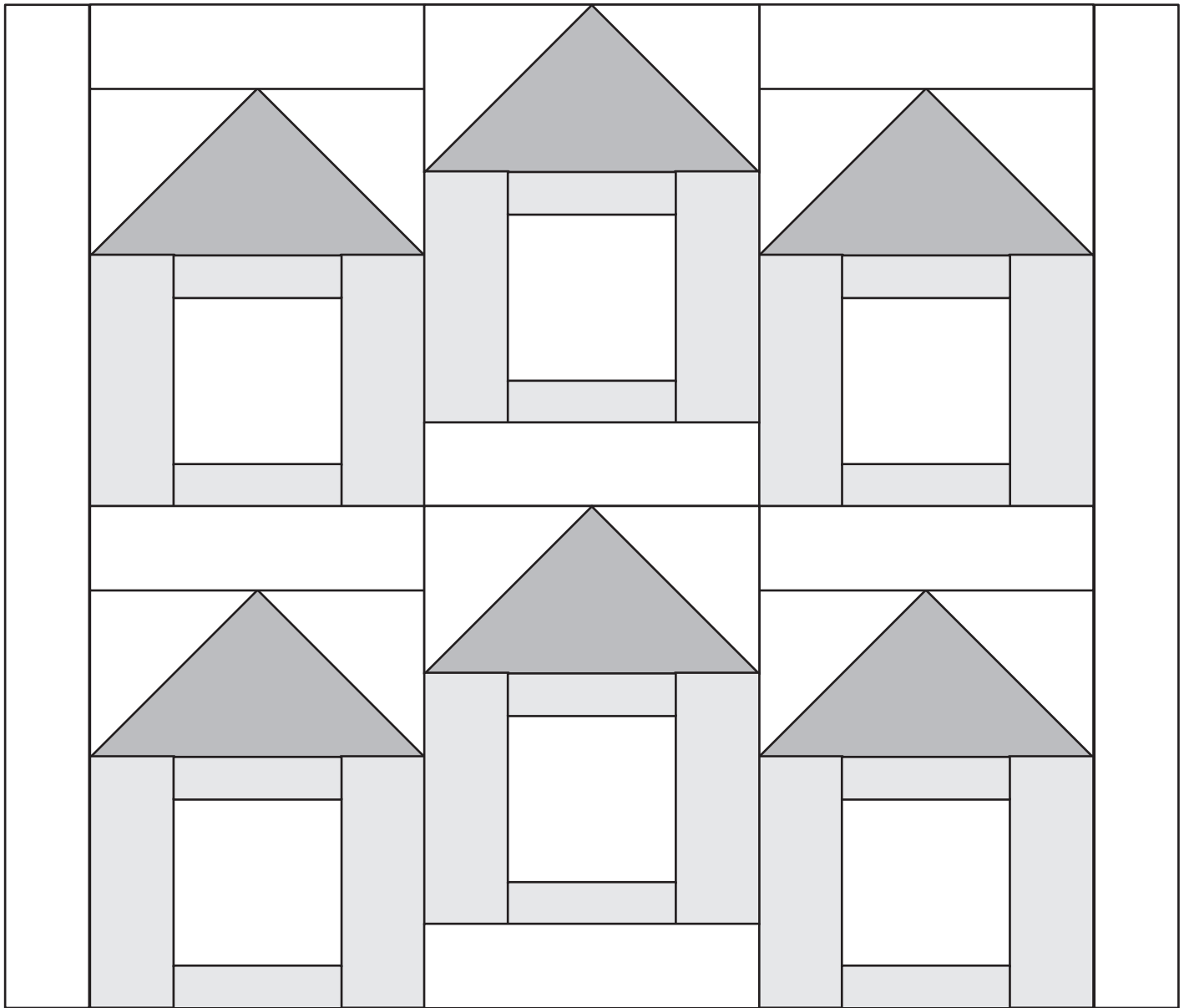

## General Information

- These are very scrappy blocks. Mix your favorite Moda prints to create your colorful neighborhood!
- Share your progress and final quilt at #BeMyNeighbor. We love to see your results!!!

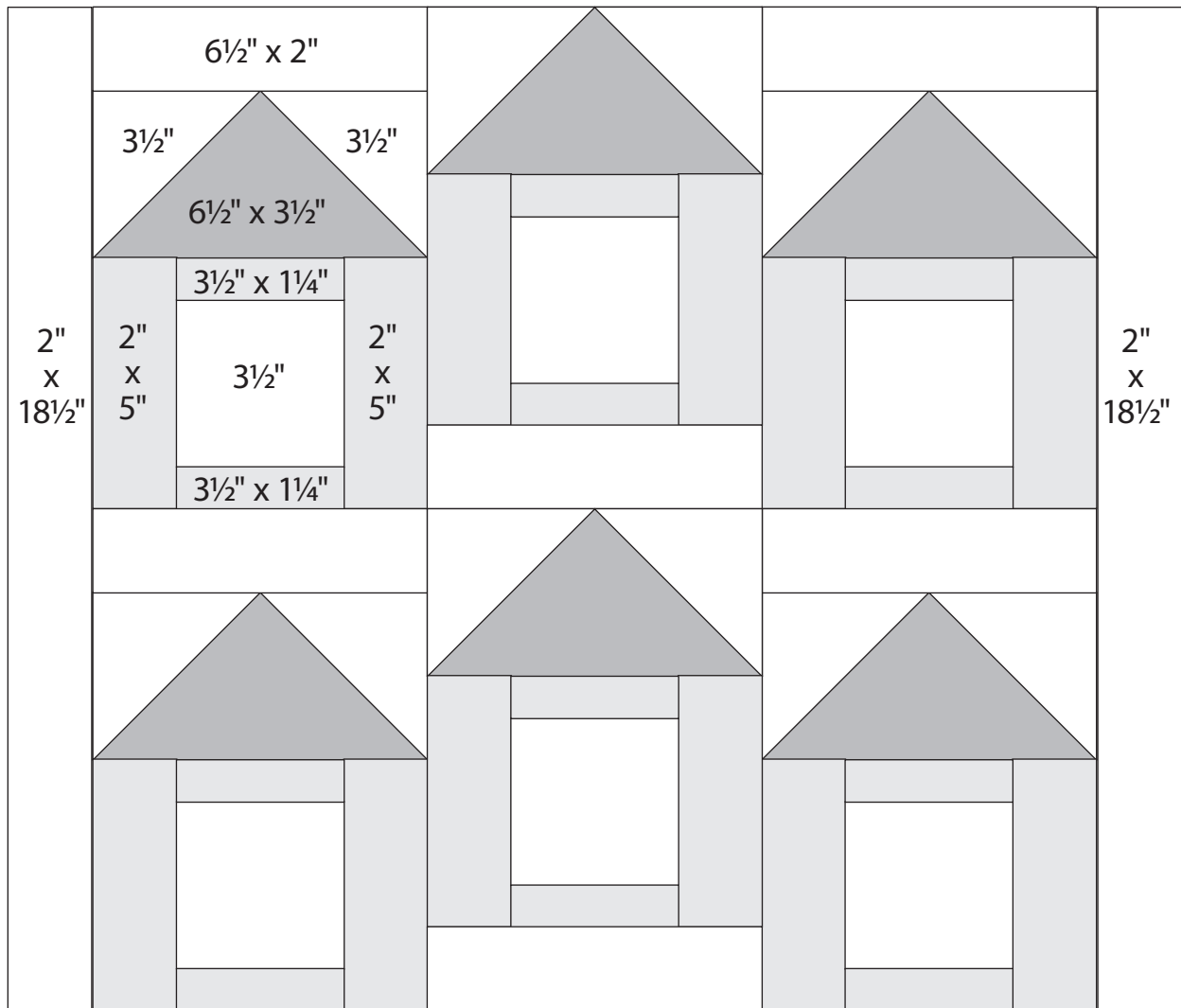

Block 11  
21½" x 18½" unfinished

## Cutting

### House Roof

6–6½" x 3½" rectangles

### Window

6–3½" squares

### House

12–5" x 2" rectangles

12–3½" x 1¼" rectangles

### Background

6–6½" x 2" rectangles

12–3½" squares

2–2" x 18½" rectangles

*moda*



moda

# Be My Neighbor

Block 11 is 21" x 18" finished.

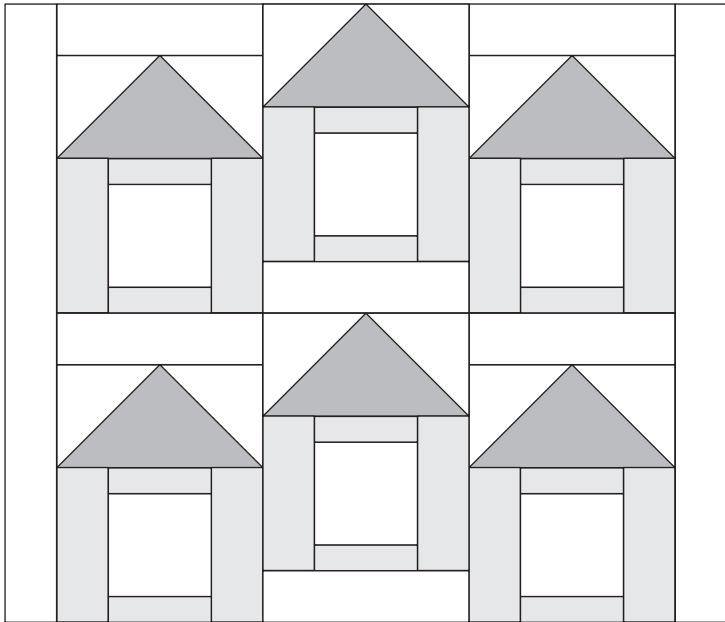

moda

## Construction

Use 1/4" seams. Press in the direction of the arrows in the diagrams.

**1 House Roof**  
 Draw a diagonal line from corner to corner on the wrong side of 12-3/2" background squares. Layer a 3-1/2" marked background square, right sides together, on 1-6-1/2" x 3-1/2" roof rectangle as shown. Sew on the diagonal line. Trim 1/4" from the sewn line. Press to reveal the triangle. Repeat on the the opposite end of the same rectangle. Make 6.

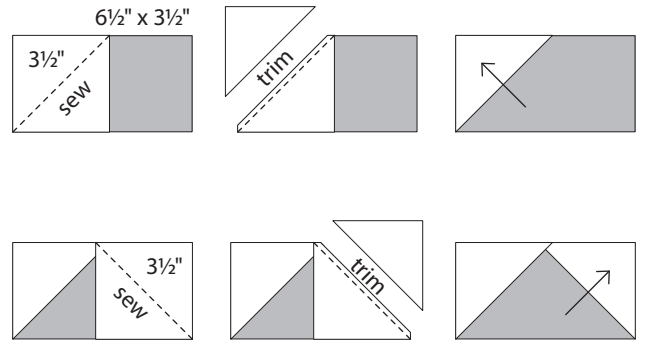

House Roof  
6 1/2" x 3 1/2" unfinished  
Make 6.

**2 Assemble the house as shown.**

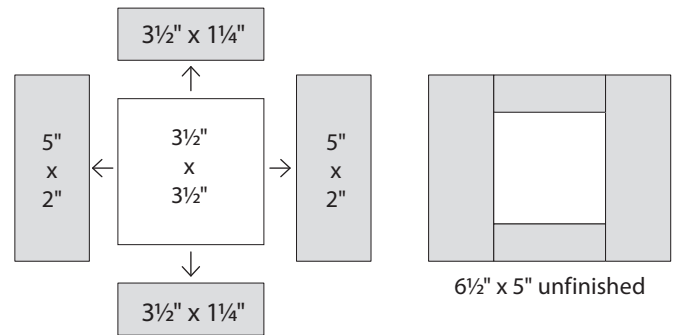

6 1/2" x 5" unfinished

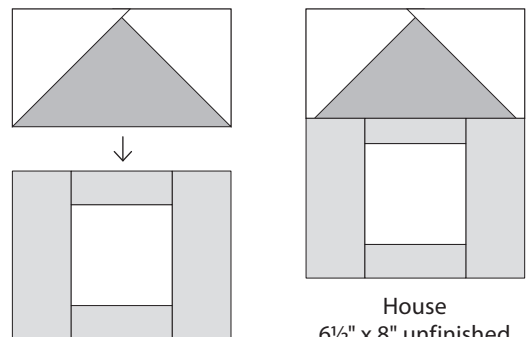

House  
6 1/2" x 8" unfinished  
Make 1.

3 Assemble the block as shown.

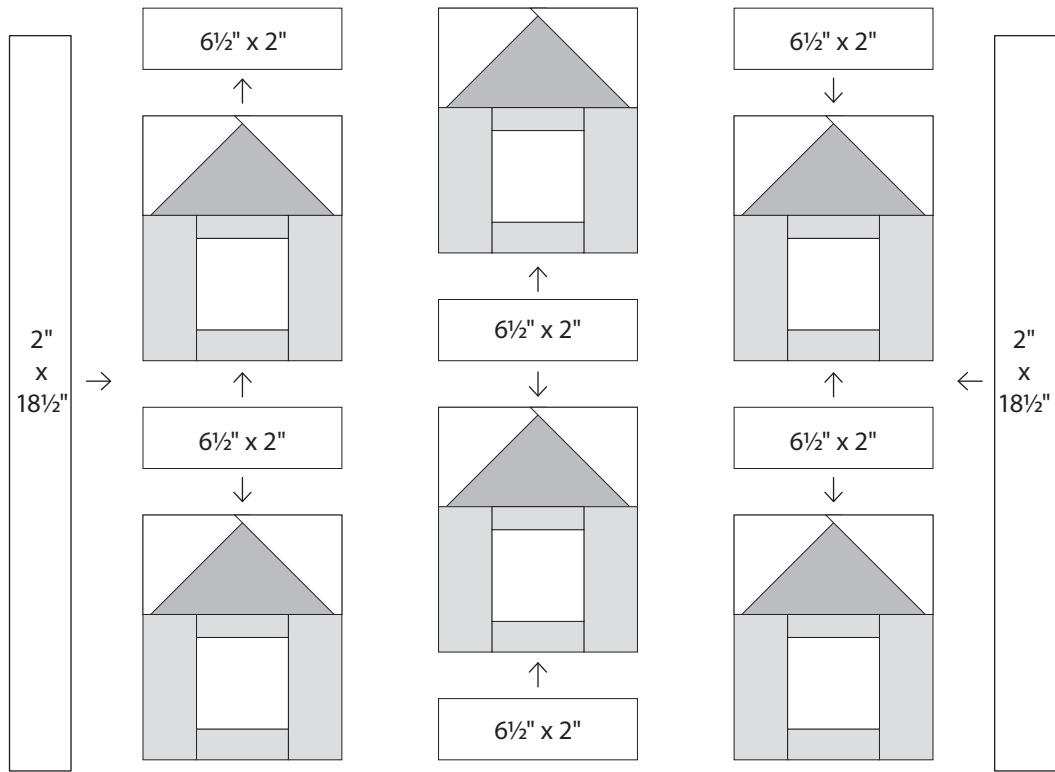

*moda*

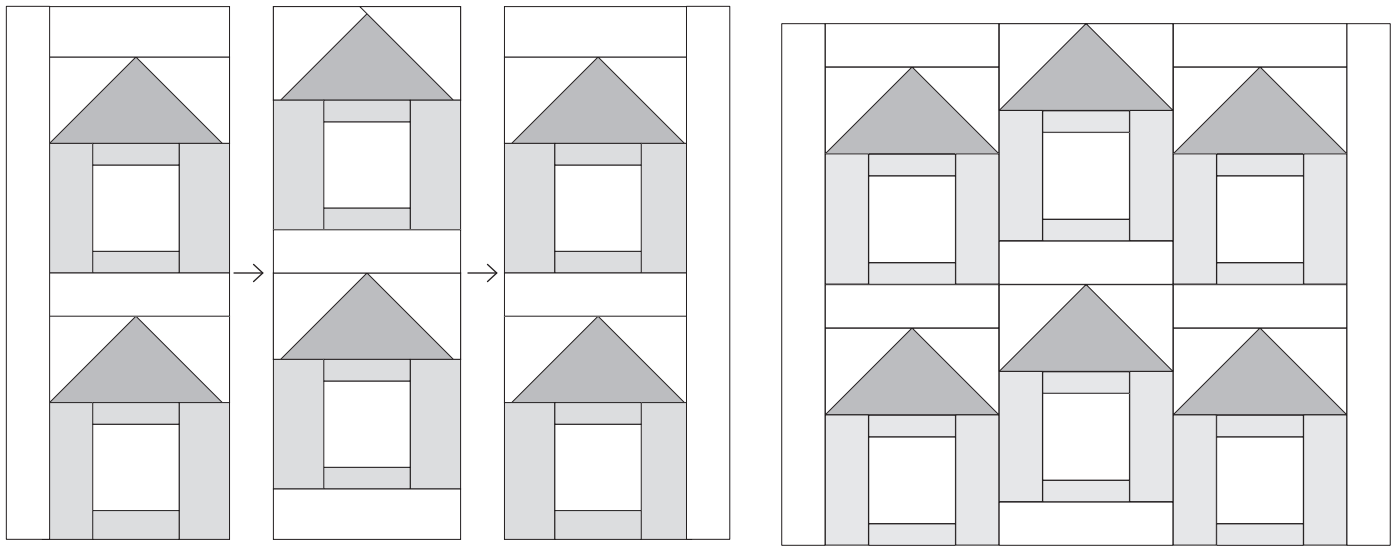

Block 11  
21 1/2" x 18 1/2" unfinished



*moda*

# Be My Neighbor

## Block 12

9" x 18" finished

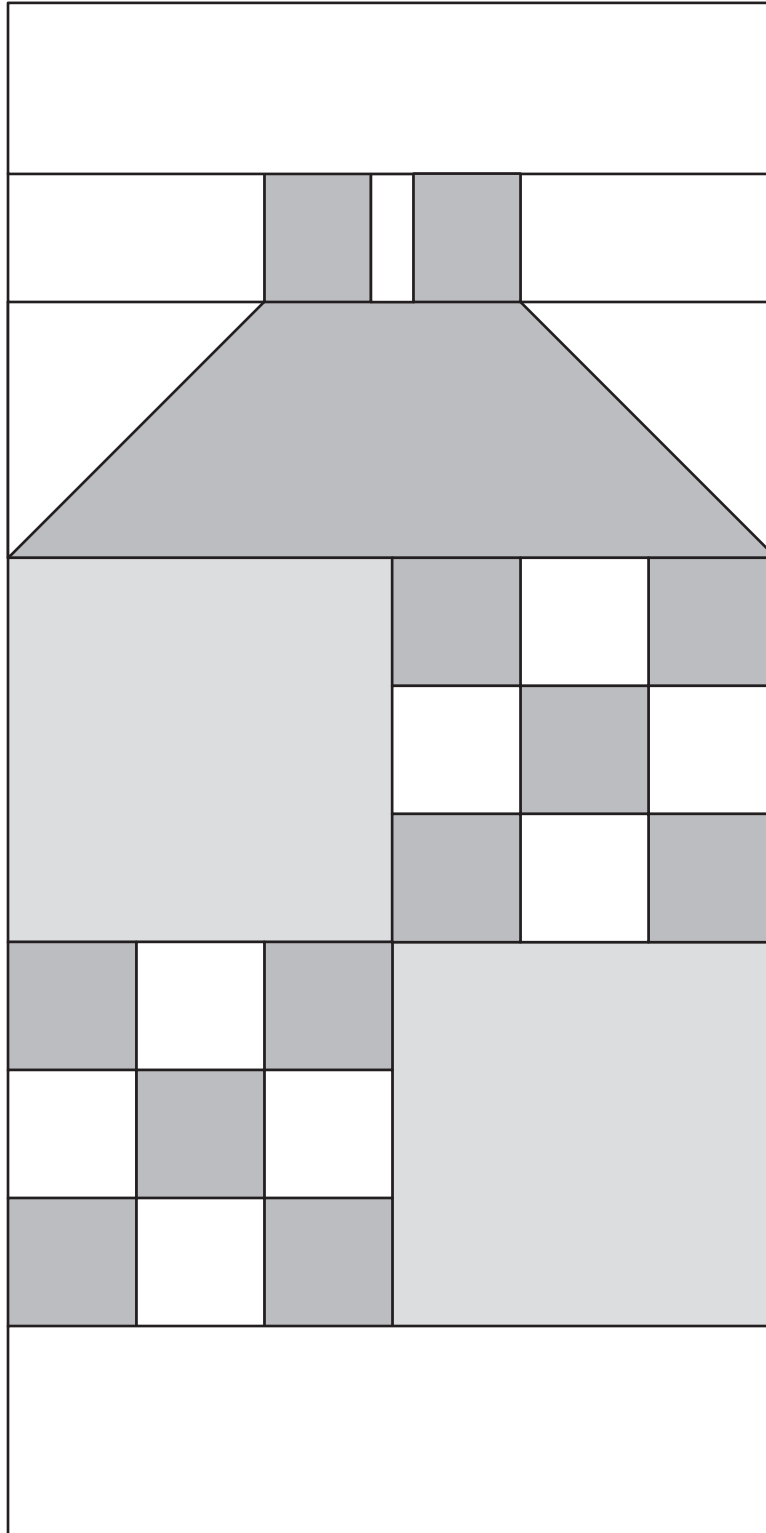

## General Information

- These are very scrappy blocks. Mix your favorite Moda prints to create your colorful neighborhood!
- Share your progress and final quilt at #BeMyNeighbor. We love to see your results!!!

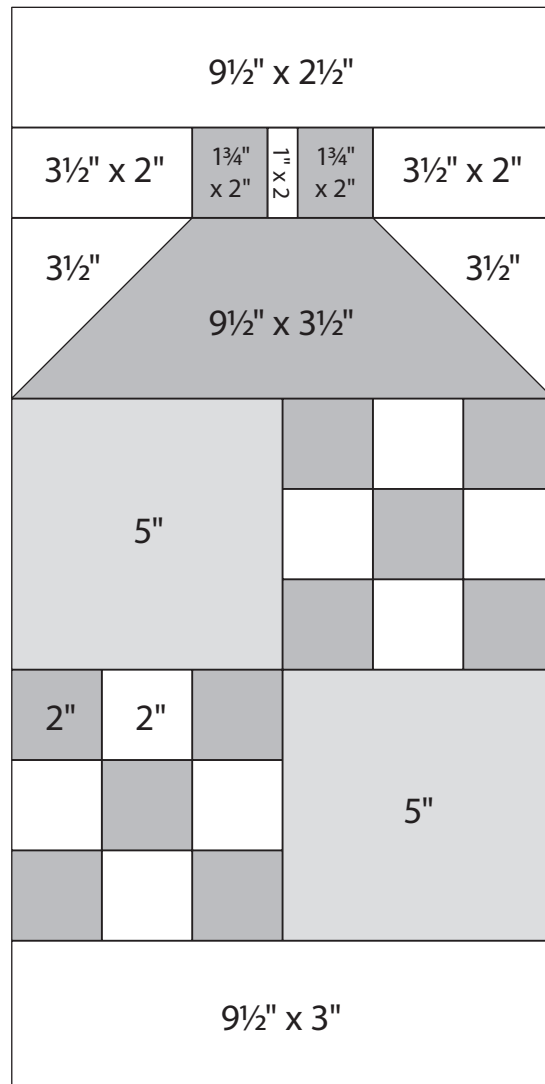

**Block 12**  
9 1/2" x 18 1/2" unfinished

## Cutting

### House Roof

1-9 1/2" x 3 1/2" rectangle

### House

2-5" squares

### Chimneys

2-1 3/4" x 2" rectangles

### Nine-Patches (dark/medium)

10-2" squares

### Background

1-9 1/2" x 3" rectangle

1-9 1/2" x 2 1/2" rectangle

2-3 1/2" squares

2-3 1/2" x 2" rectangles

8-2" squares

1-1" x 2" rectangle



# Be My Neighbor

Block 12 is 9" x 18" finished.

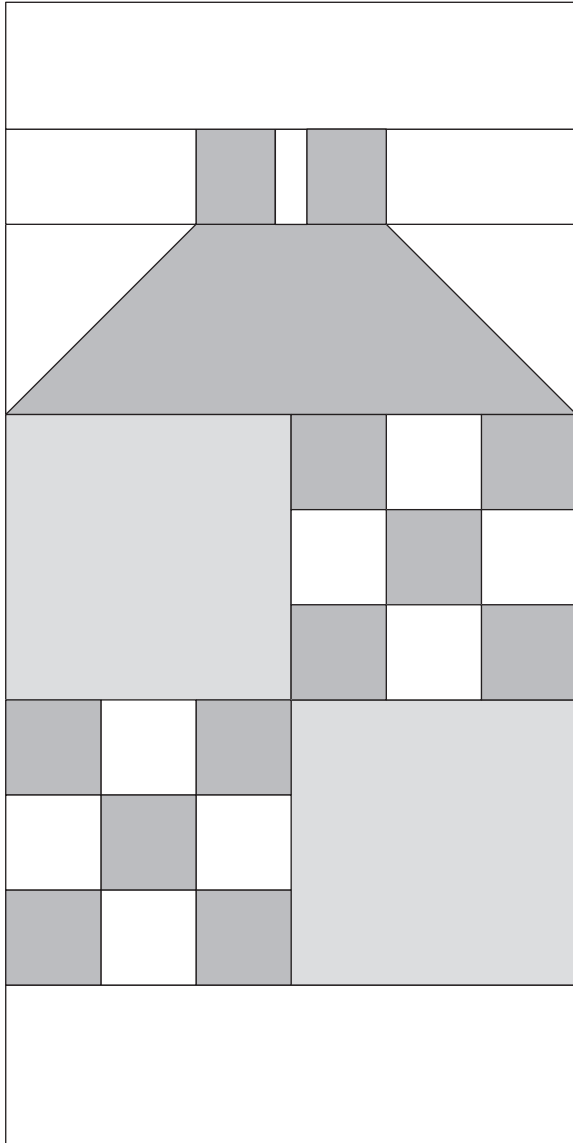

*moda*

## Construction

Use ¼" seams. Press in the direction of the arrows in the diagrams.

**1** Assemble the chimneys as shown.

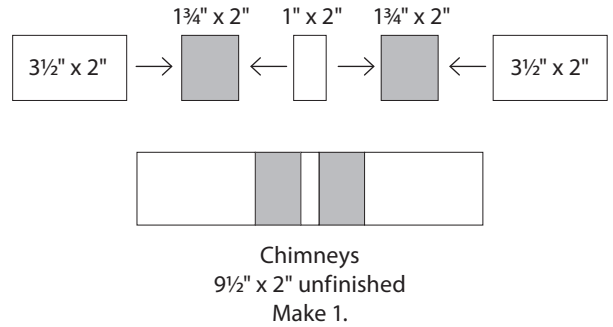

**2** House Roof

Draw a diagonal line from corner to corner on the wrong side of 2–3½" background squares. Layer a 3½" marked background square, right sides together, on 1–9½" x 3½" roof rectangle as shown. Sew on the diagonal line. Trim ¼" from the sewn line. Press to reveal the triangle. Repeat on the the opposite end of the same rectangle. Make 1.

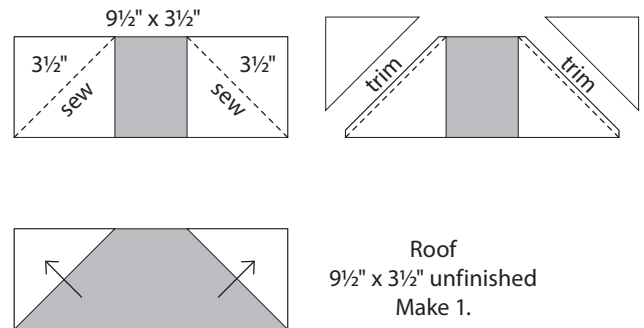

**3** Nine-Patch

Arrange 5–2" dark/medium squares and 4–2" background squares and 3 rows as shown. Join the rows. Make 2 nine-patches.

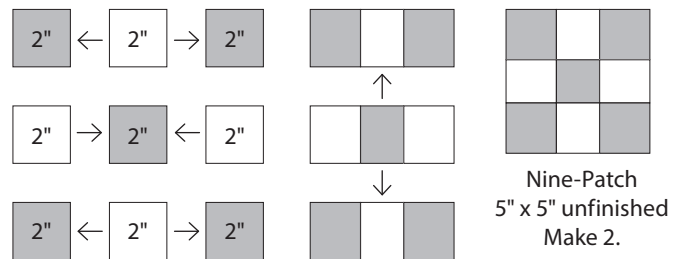

4 Assemble the block as shown.

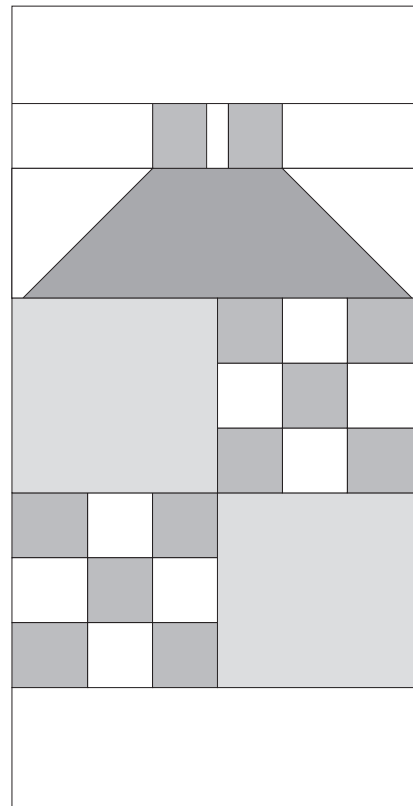
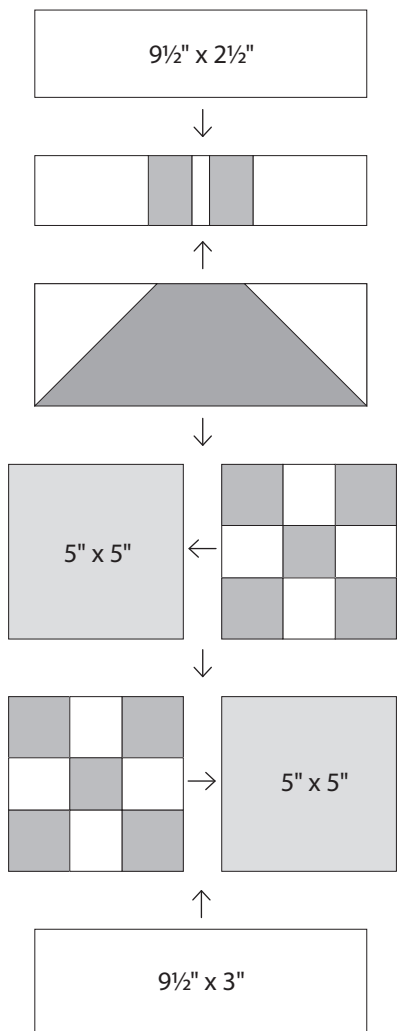

Block 12  
 $9\frac{1}{2}" \times 18\frac{1}{2}"$  unfinished

*moda*





*moda*

# Be My Neighbor

## Block 13

10½" x 18" finished

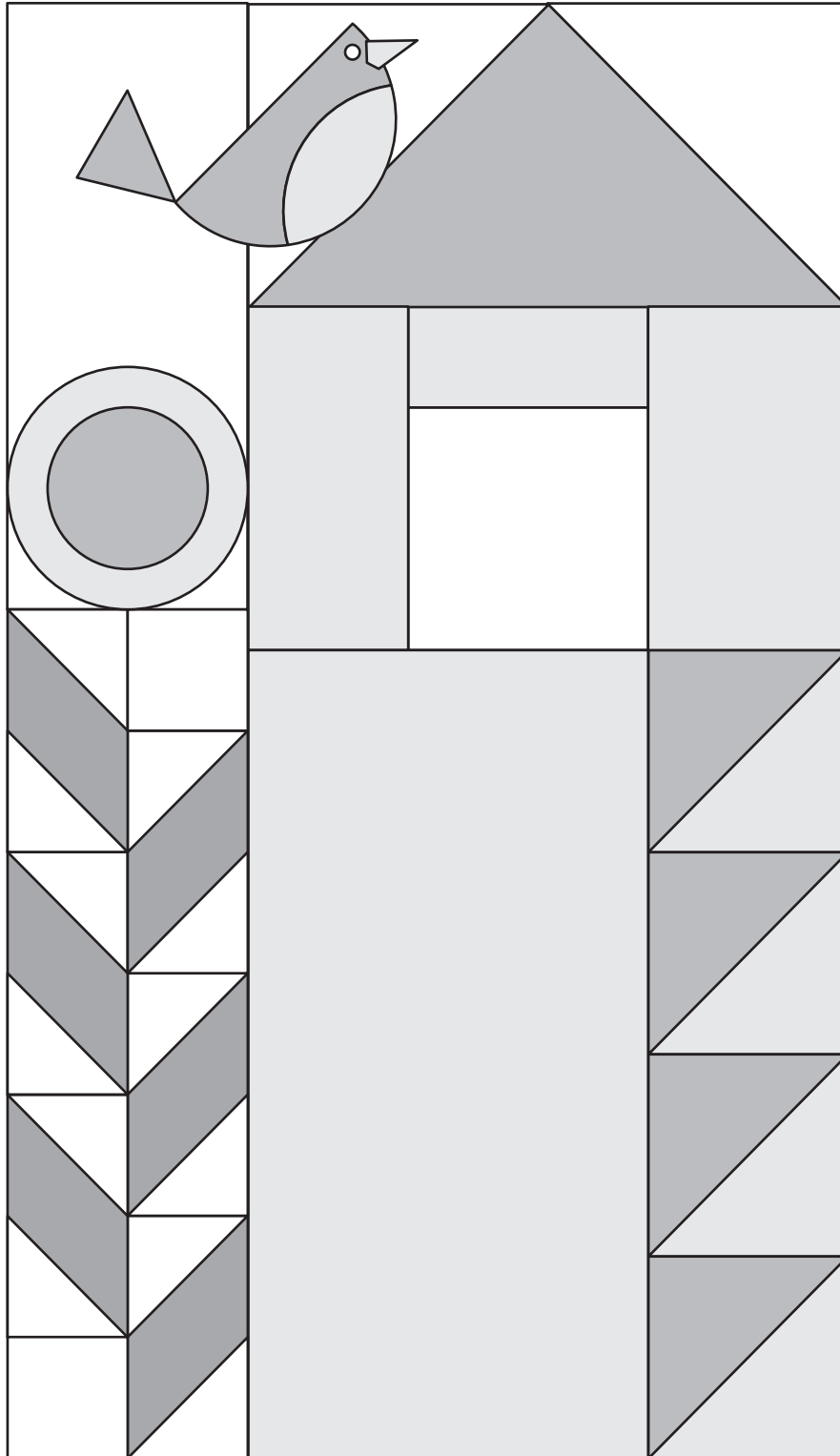

## General Information

- These are very scrappy blocks. Mix your favorite Moda prints to create your colorful neighborhood!
- Share your progress and final quilt at #BeMyNeighbor. We love to see your results!!!

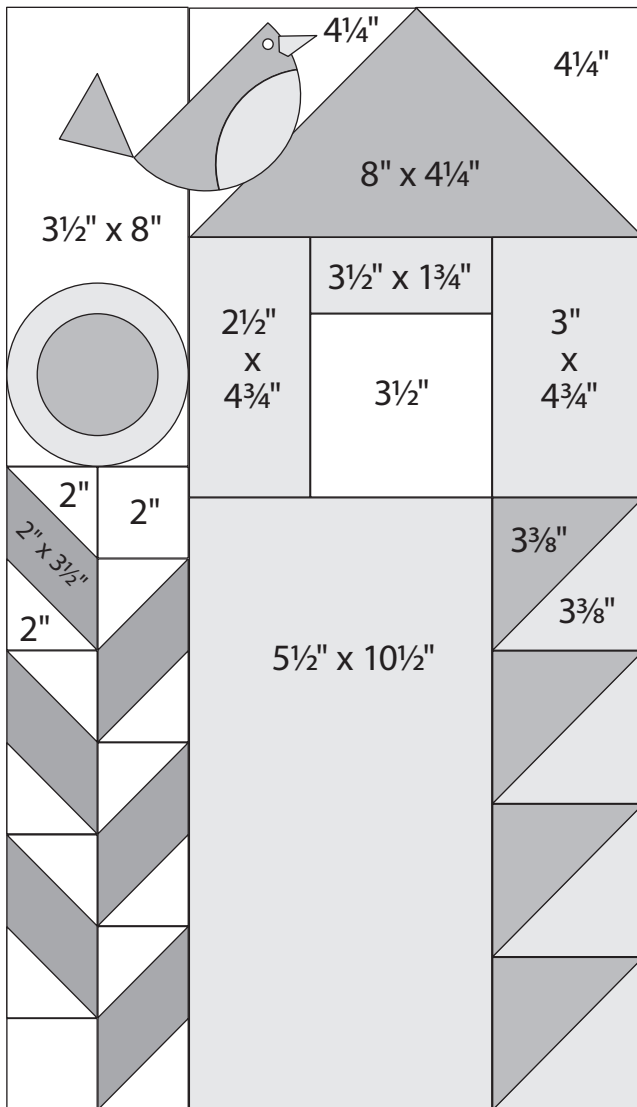

**Block 13**  
11" x 18½" unfinished

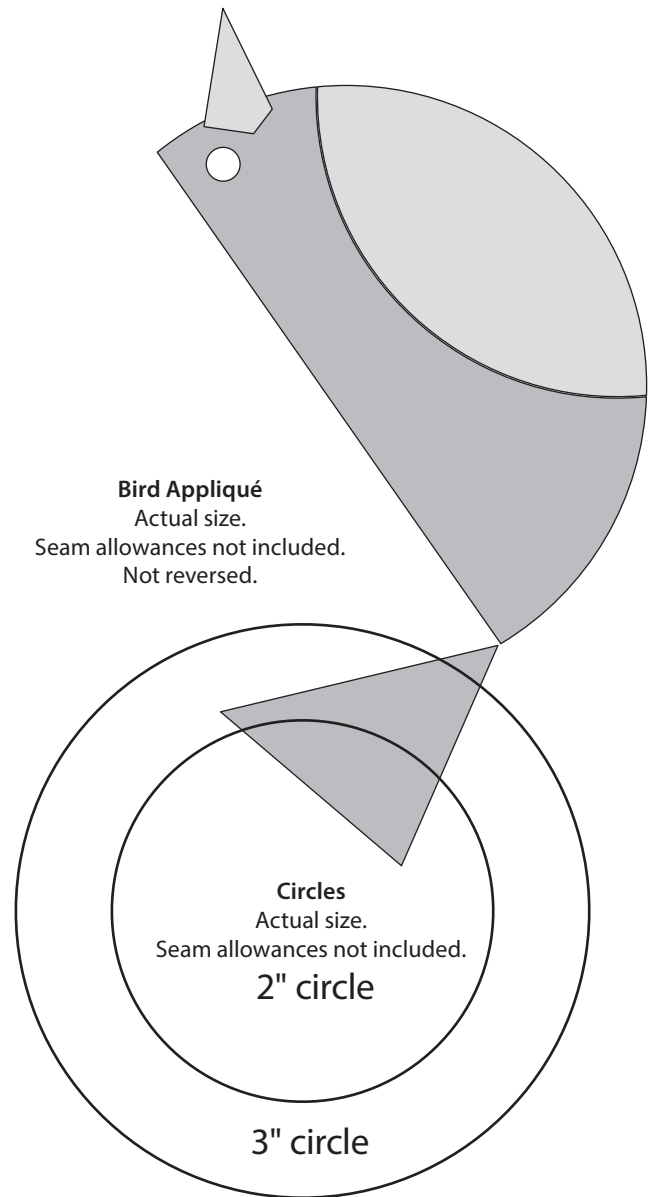

## Cutting

Leaves	Roof	House	Background
6–2" x 3½" rectangles	1–8" x 4¼" rectangle	1–5½" x 10½" rectangle	2–4¼" squares
<b>Flowers</b>	<b>Half-Square Triangles</b>	2–3⅜" squares; cut in half once on the diagonal to make 4 half-square triangles (HST)	14–2" squares
2 circles	2–3⅜" squares; cut in half once on the diagonal to make 4 half-square triangles (HST)	1–3½" x 1¾" rectangle	1–3½" x 8" rectangle
<b>Bird Appliqué</b>	<b>Window</b>	1–3" x 4¾" rectangle	
1–beak	1–3½" square	1–2½" x 4¾" rectangle	
1–body			
1–tail			
1–wing			
1–eye			



# Be My Neighbor

Block 13 is 10½" x 18" finished.

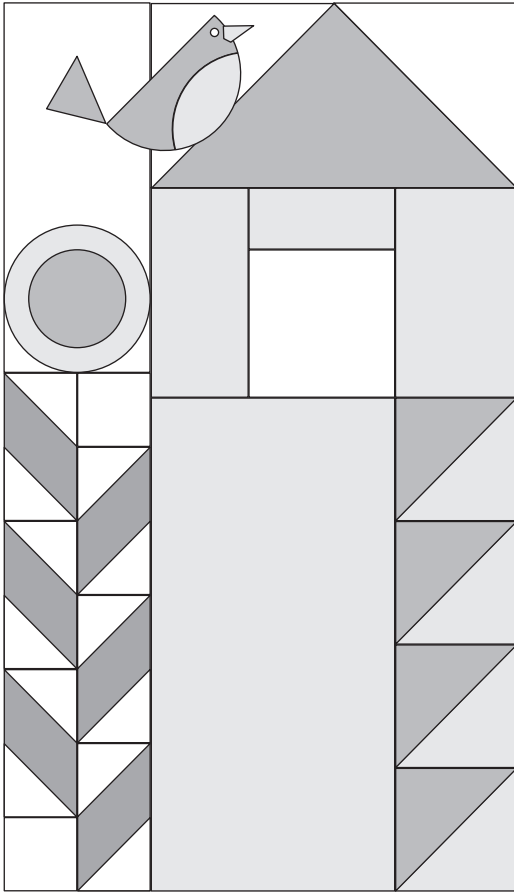

## Construction

Use ¼" seams. Press in the direction of the arrows in the diagrams.

### 1 House Roof

Draw a diagonal line from corner to corner on the wrong side of 2–4¼" background squares. Layer a 4¼" marked background square, right sides together, on 1–8" x 4¼" roof rectangle as shown. Sew on the diagonal line. Trim ¼" from the sewn line. Press to reveal the triangle. Repeat on the opposite end of the same rectangle. Make 1.

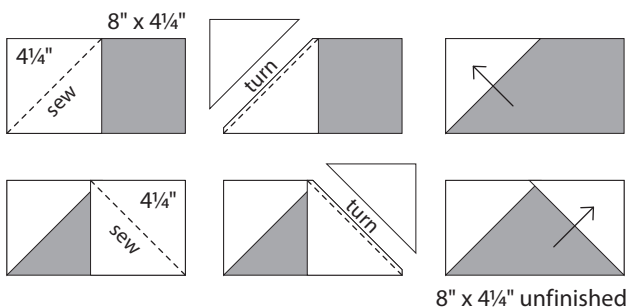

### 2 Flower

(A) Draw a diagonal line from corner to corner on the wrong side of 12–2" background squares. Layer a 2" marked background square, right sides together, on 1–2" x 3½" leaf rectangle as shown. Sew on the diagonal line. Trim ¼" from the sewn line. Press to reveal the triangle. Repeat on the opposite end of the same rectangle. Make 3 leaf As and 3 leaf Bs.

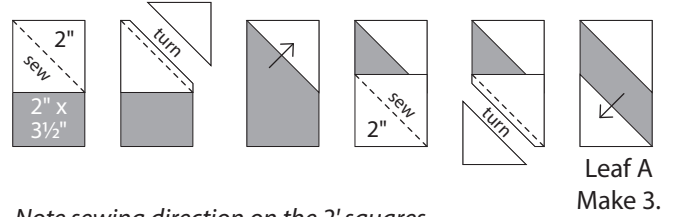

Note sewing direction on the 2" squares.

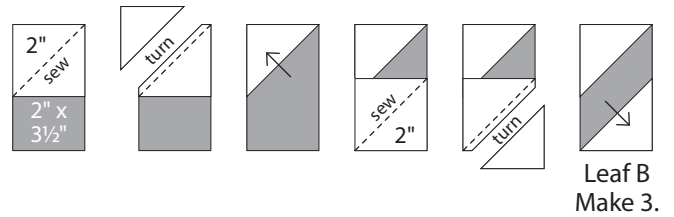

(B) Arrange and sew 3–Leaf As and 1–2" background square to make column A. Arrange sew 1–2" background square and sew 3–Leaf Bs to make column B. Join the columns, add a 3½" x 8" background rectangle. Use your appliqué method of choice to add the circles.

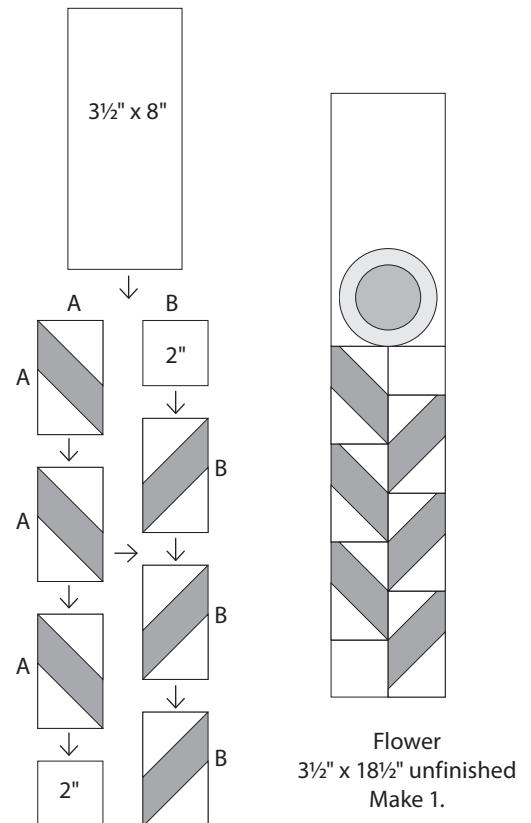

3 Join a  $3\frac{3}{8}$ " dark HST and a  $3\frac{3}{8}$ " house HST as shown. Make 4 half-triangle squares (HTS). Join the HTSs and a  $5\frac{1}{2}$ " x  $10\frac{1}{2}$ " house rectangle as shown.

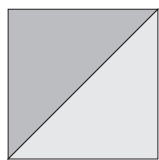
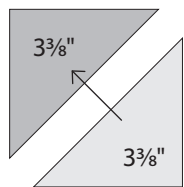

HTSs  
3" x 3"  
unfinished  
Make 4.

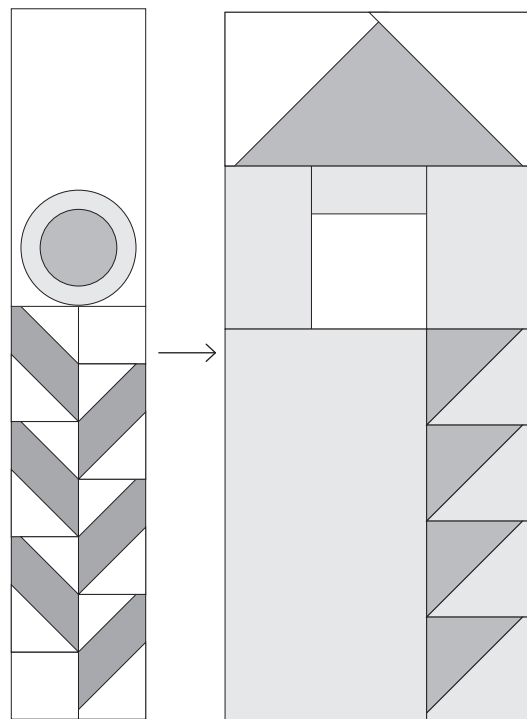
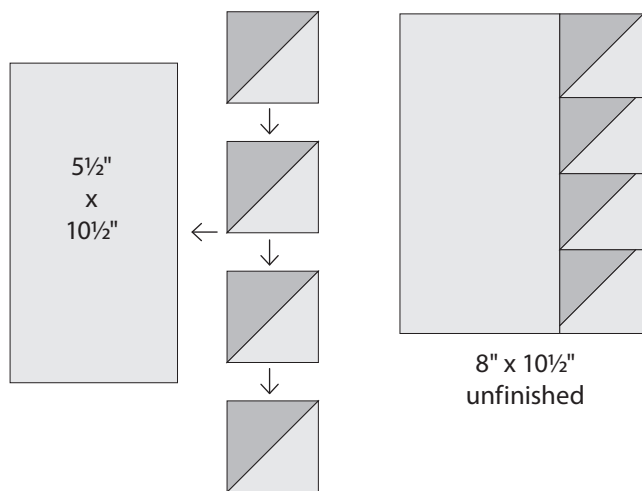

*moda*

4 Assemble the house as shown. Use fusible web and a zig zag or blanket stitch to add the bird to the completed house block.

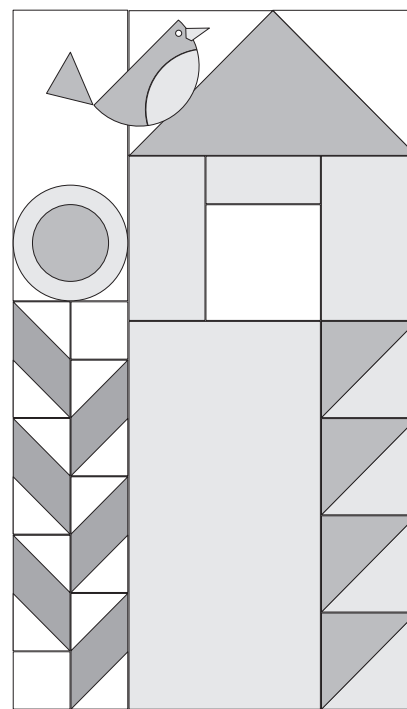
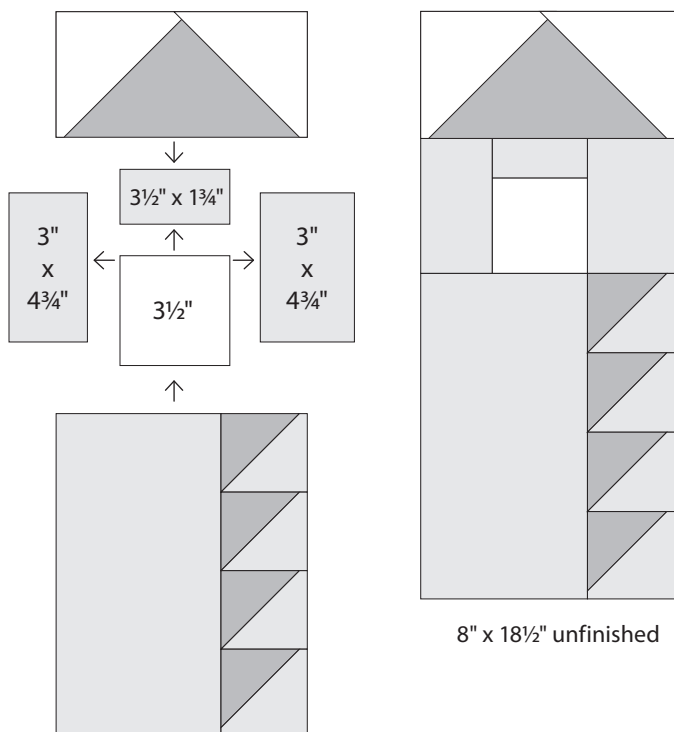

Block 13  
11" x 18 1/2" unfinished



*moda*

# Be My Neighbor

## Block 14

12" x 18" finished

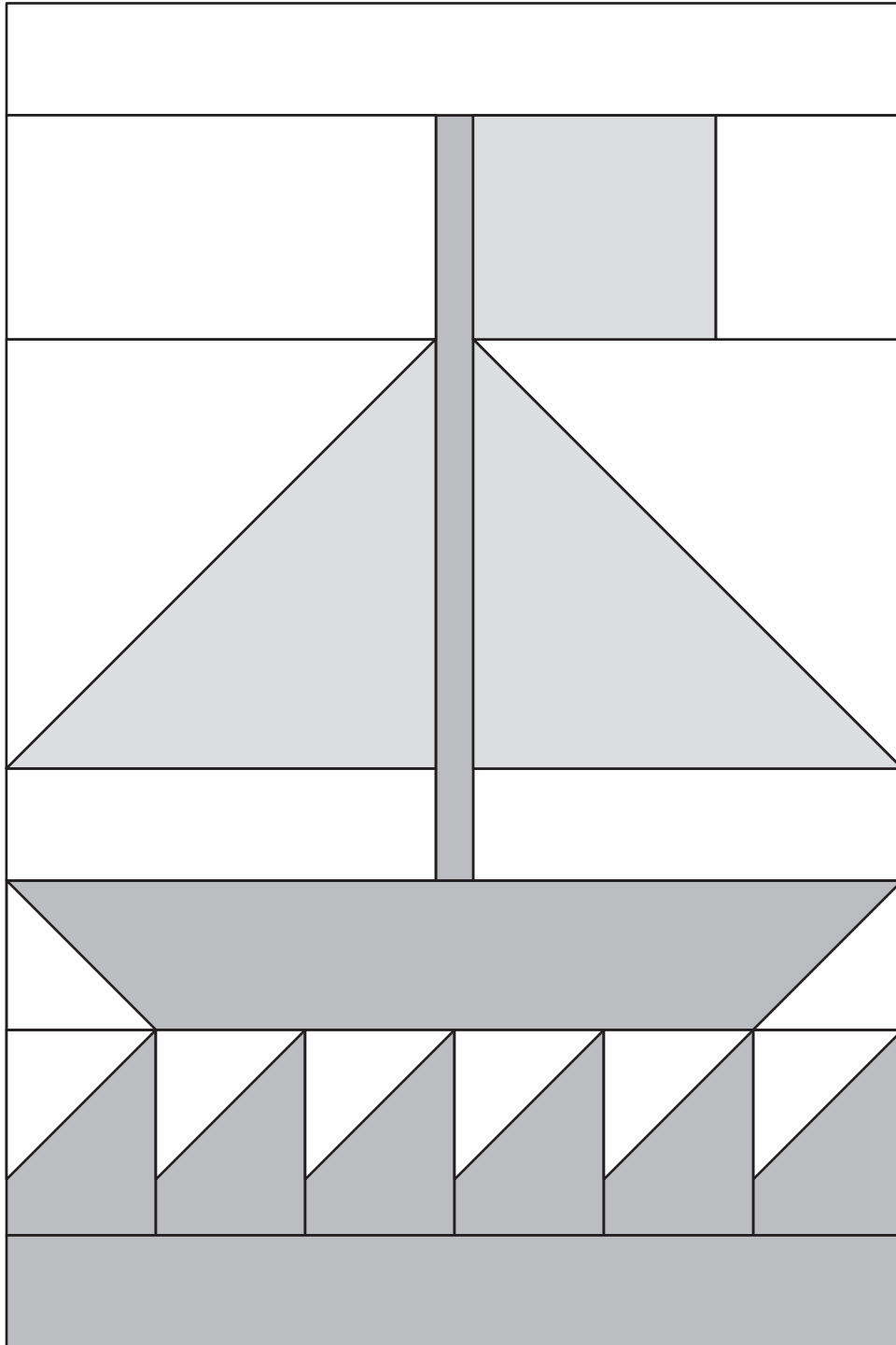

## General Information

- These are very scrappy blocks. Mix your favorite Moda prints to create your colorful neighborhood!
- Share your progress and final quilt at #BeMyNeighbor. We love to see your results!!!

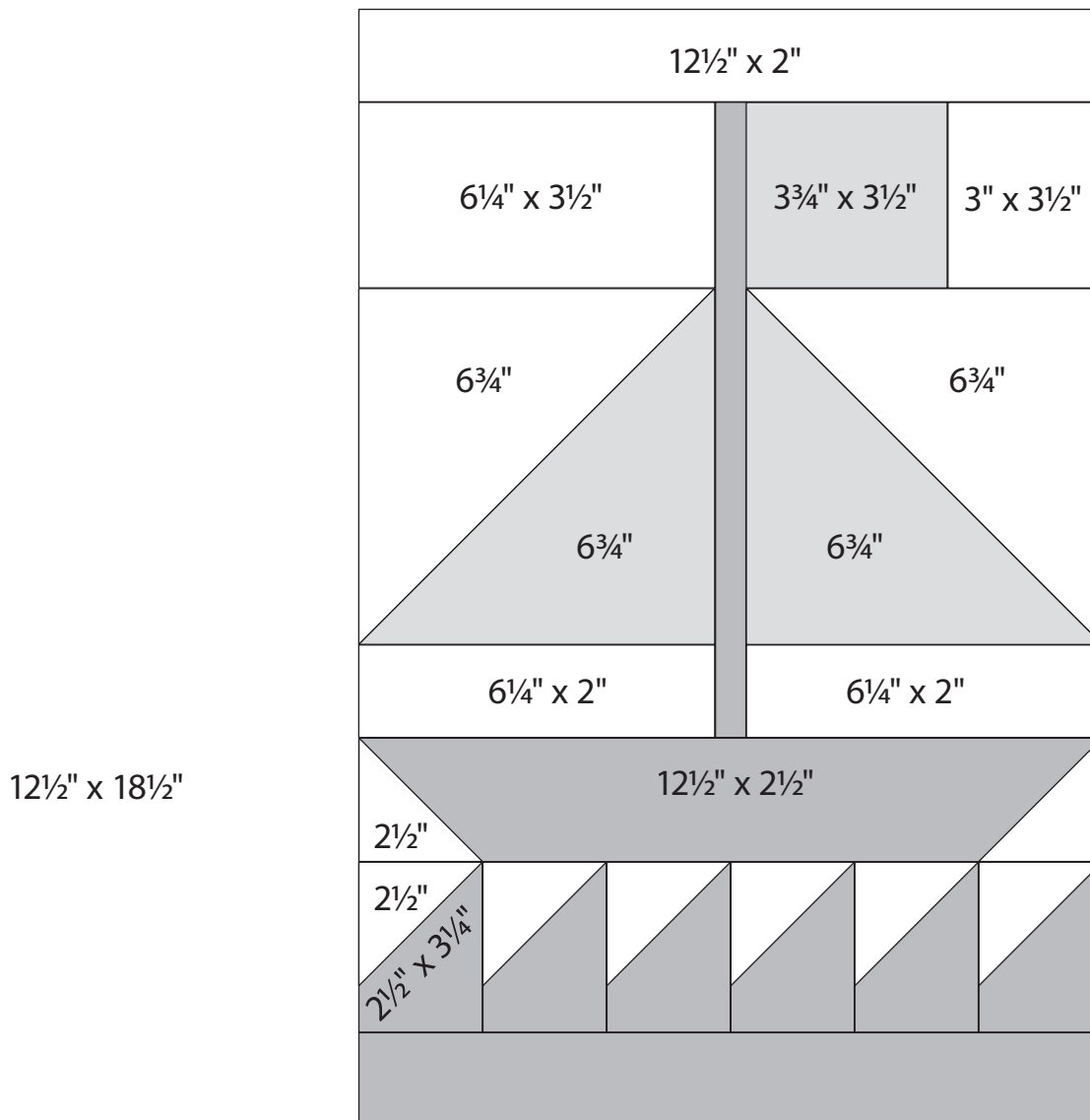

**Block 14**  
 $12\frac{1}{2}'' \times 18\frac{1}{2}''$  unfinished

## Cutting

<p><b>Flag</b> 1-<math>3\frac{3}{4}'' \times 3\frac{1}{2}''</math> rectangle</p> <p><b>Sails</b> 1-<math>6\frac{3}{4}''</math> square cut in half once on the diagonal to make 2 half-square triangles</p> <p><b>Mast</b> 1-<math>1'' \times 10\frac{3}{4}''</math> rectangle</p>	<p><b>Boat</b> 1-<math>12\frac{1}{2}'' \times 2\frac{1}{2}''</math> rectangle</p> <p><b>Waves and Water</b> 6-<math>2\frac{1}{2}'' \times 3\frac{1}{4}''</math> rectangles 1-<math>12\frac{1}{2}'' \times 2''</math> rectangle</p>	<p><b>Background</b> 1-<math>12\frac{1}{2}'' \times 2''</math> rectangle 1-<math>6\frac{3}{4}''</math> square cut in half once on the diagonal to make 2 half-square triangles 1-<math>6\frac{1}{4}'' \times 3\frac{1}{2}''</math> rectangles 2-<math>6\frac{1}{4}'' \times 2''</math> rectangles 1-<math>3'' \times 3\frac{1}{2}''</math> rectangle 8-<math>2\frac{1}{2}''</math> squares</p>
---	--	--



moda  
Be My Neighbor

Block 14 is 12" x 18" finished.

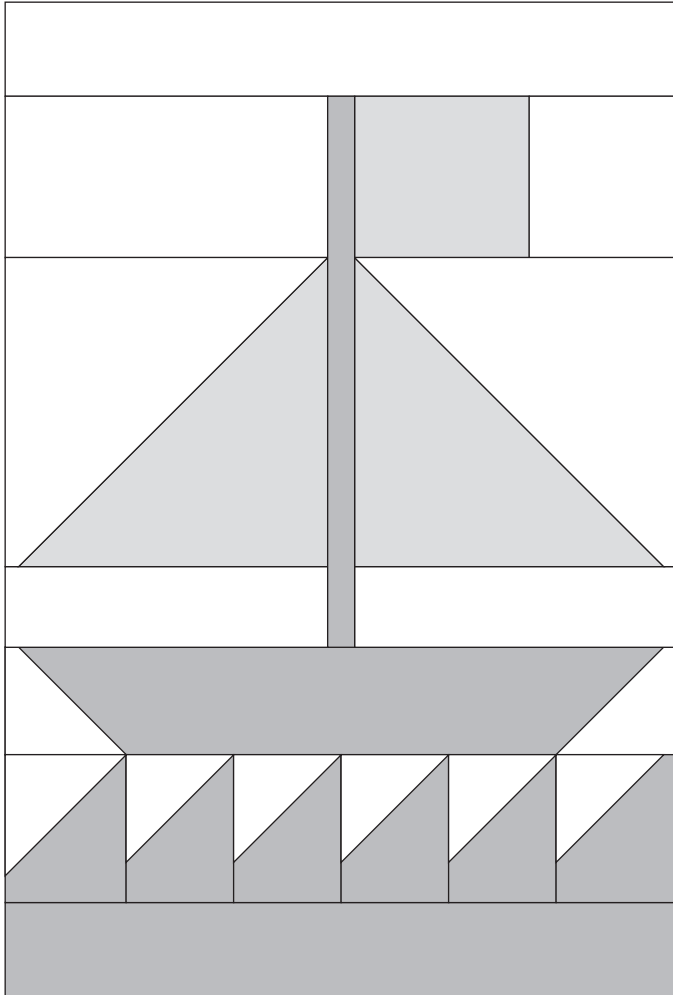

moda

### Construction

Use  $\frac{1}{4}$ " seams. Press in the direction of the arrows in the diagrams.

- 1 Sails**  
Join 1- $6\frac{3}{4}$ " sail half-square triangle and 1- $6\frac{3}{4}$ " background half-square triangle as shown. Make 2.

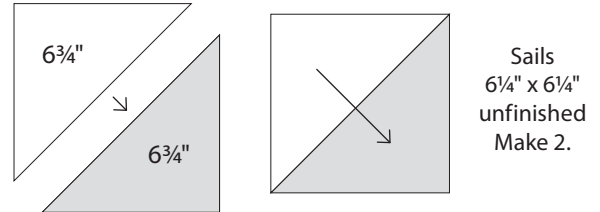

- 2 Boat**  
Draw a diagonal line from corner to corner on the wrong side of 2- $2\frac{1}{2}$ " background squares. Layer a  $2\frac{1}{2}$ " marked background square, right sides to together, on 1- $12\frac{1}{2}$ " x  $2\frac{1}{2}$ " boat rectangle as shown. Sew on the diagonal line. Trim  $\frac{1}{4}$ " from the sewn line. Press to reveal the triangle. Repeat on the the opposite end of the same rectangle.

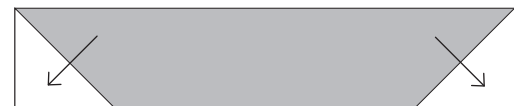
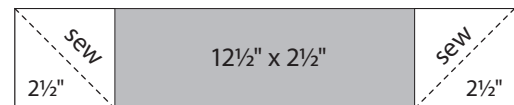

Boat  $2\frac{1}{2}$ " x  $12\frac{1}{2}$ " unfinished

### 3 Waves

Draw a diagonal line from corner to corner on the wrong side of 6-2½" background squares. Layer a 2½" marked background square, right sides to together, on 1-2½" x 3¼" wave rectangle as shown. Sew on the diagonal line. Trim ¼" from the sewn line. Press to reveal the triangle. Join the 6 waves.

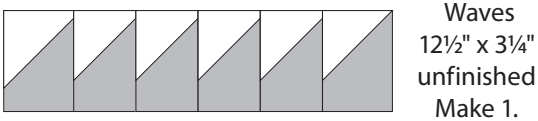
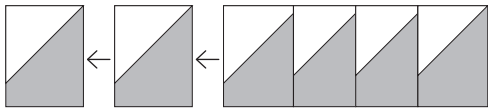
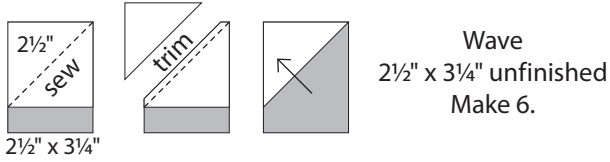

### 4 Assemble flag and sail.

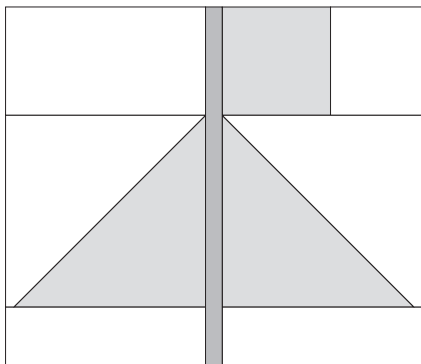
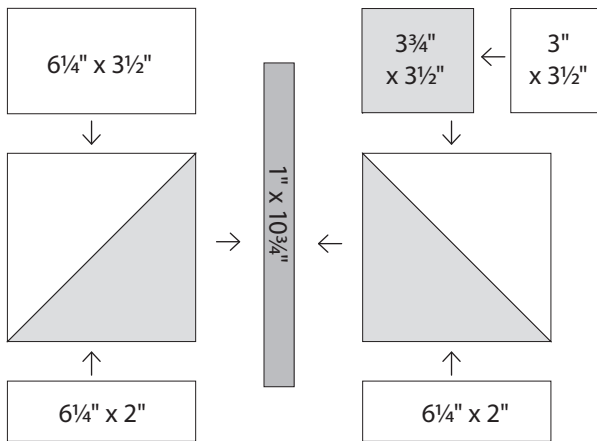

Flag and Sail  
12½" x 10¾" unfinished

### 5 Assemble the block as shown.

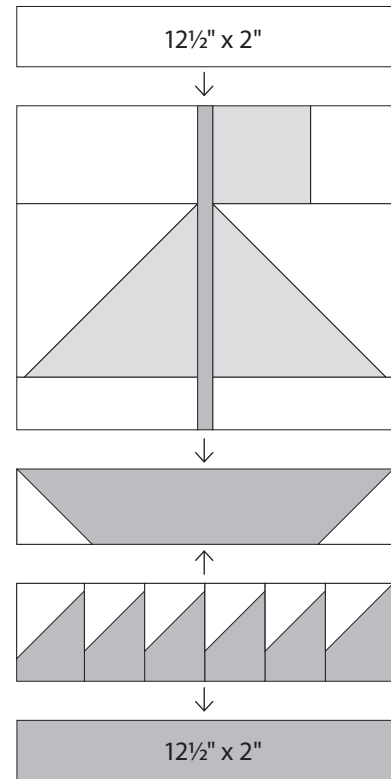

*moda*

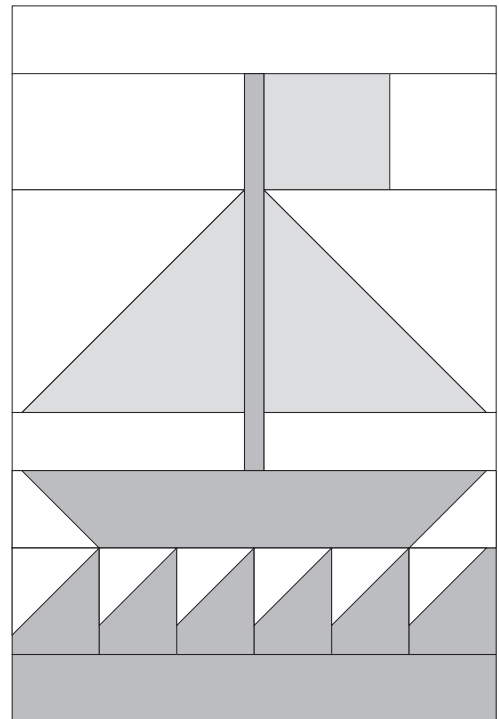

Block 14  
12½" x 18½" unfinished





*moda*

# Be My Neighbor

**Block 15**  
15" x 18" finished

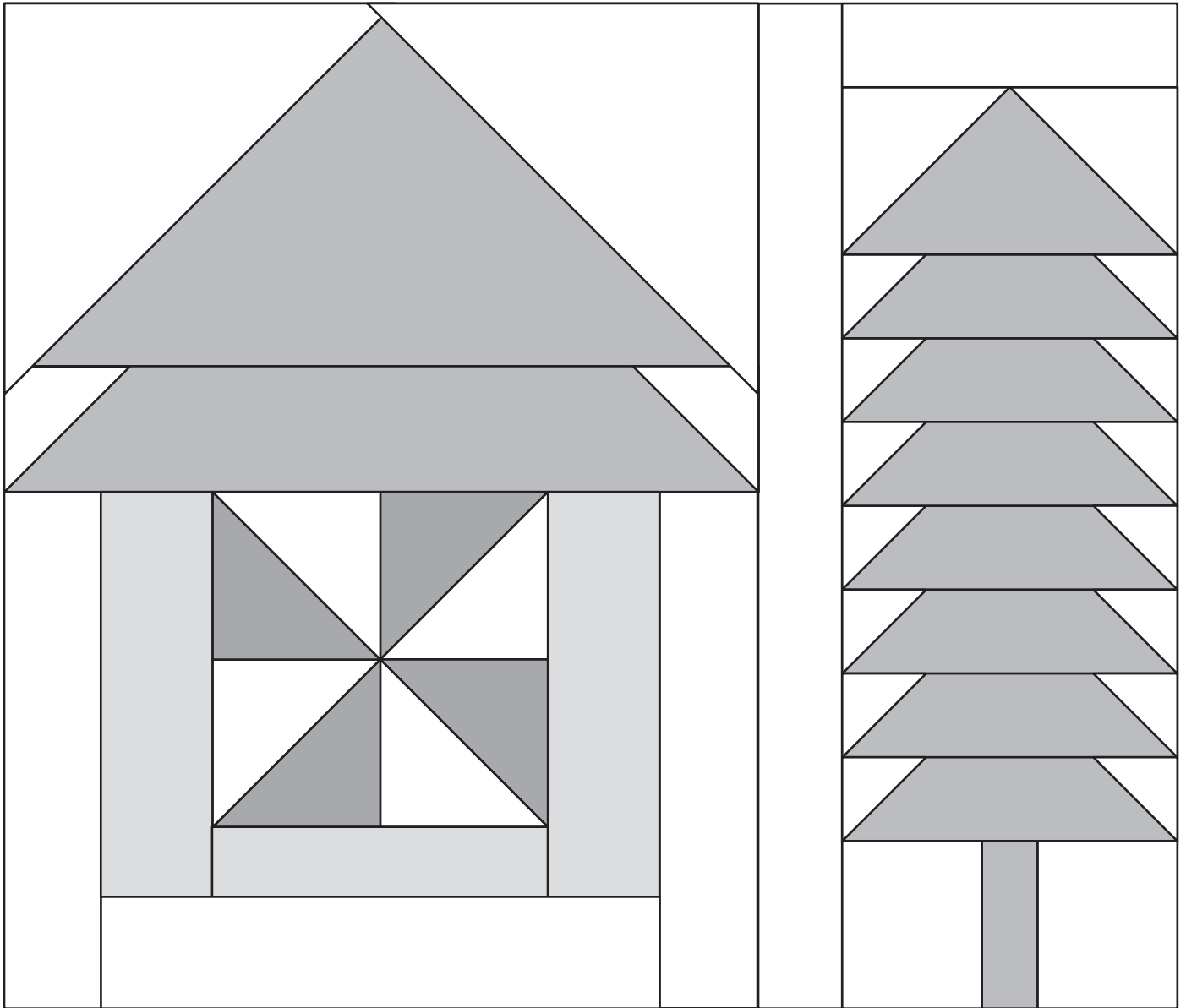

## General Information

- These are very scrappy blocks. Mix your favorite Moda prints to create your colorful neighborhood!
- Share your progress and final quilt at #BeMyNeighbor. We love to see your results!!!

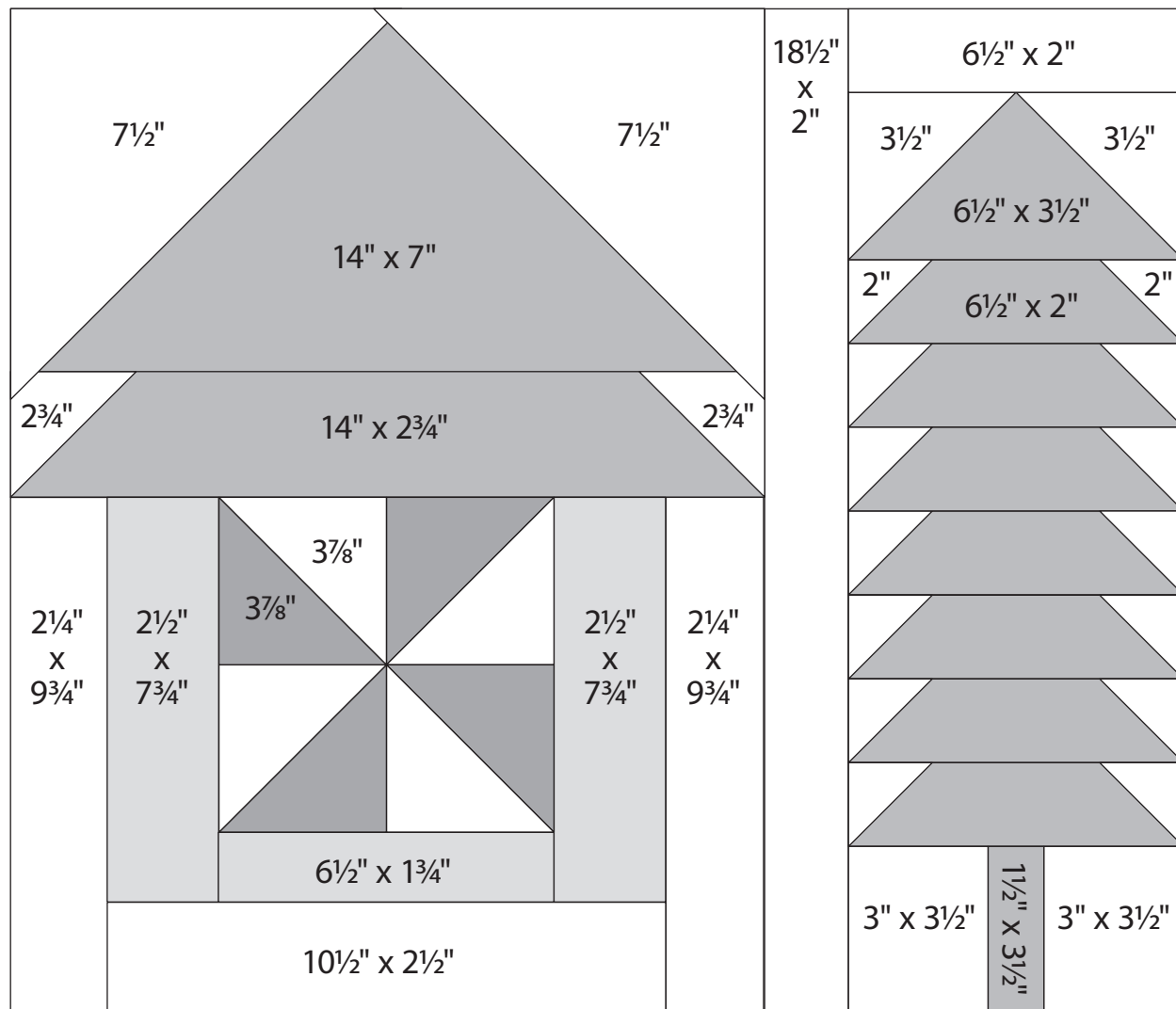

**Block 15**  
15½" x 18½" unfinished

## Cutting

### House Roof

- 1–14" x 7" rectangle
- 1–14" x 2¾" rectangle

### House

- 1–6½" x 1¾" rectangle
- 2–2½" x 7¾" rectangles

### Pinwheel Dark

- 2–3⅞" squares
- cut in half once on the diagonal to make 4 half-square triangles

### Pinwheel Light

- 2–3⅞" squares
- cut in half once on the diagonal to make 4 half-square triangles

### Tree

- 1–6½" x 3½" rectangle
- 7–6½" x 2" rectangles

### Tree Trunk

- 1–1½" x 3½" rectangle

### Background

- 1–18½" x 2" rectangle
- 1–10½" x 2½" rectangle
- 1–6½" x 2" rectangle
- 2–7½" squares
- 2–3½" squares
- 2–3" x 3½" rectangles
- 2–2¾" squares
- 2–2¼" x 9¾" rectangles
- 14–2" squares



# moda Be My Neighbor

Block 15 is 15" x 18" finished.

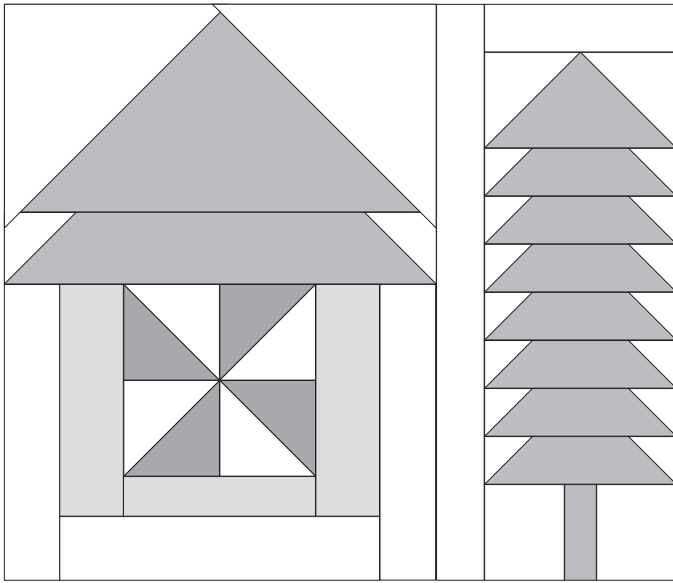

## Construction

Use  $\frac{1}{4}$ " seams. Press in the direction of the arrows in the diagrams.

### 1 House

- (A) Draw a diagonal line from corner to corner on the wrong side of  $2-2\frac{3}{4}$ " background squares. Layer a  $2\frac{3}{4}$ " marked background square, right sides together, on  $1-14" \times 2\frac{3}{4}$ " roof rectangle as shown. Sew on the diagonal line. Trim  $\frac{1}{4}$ " from the sewn line. Press to reveal the triangle. Repeat on the the opposite end of the same rectangle.

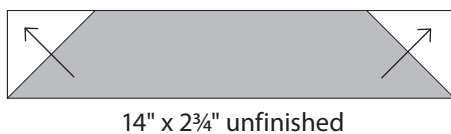
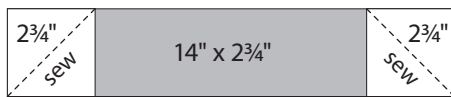

moda

House continued . . .

- (B) Add a 14" x 7" roof rectangle.

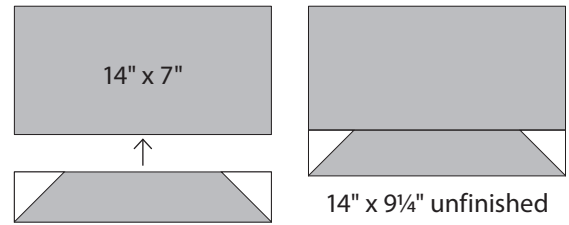

- (C) Draw a diagonal line from corner to corner on the wrong side of  $2-7\frac{1}{2}$ " background squares. Layer a  $7\frac{1}{2}$ " marked background square, right sides together, on roof rectangle from step B as shown. Sew on the diagonal line. Trim  $\frac{1}{4}$ " from the sewn line. Press to reveal the triangle. Repeat on the the opposite end of the same rectangle.

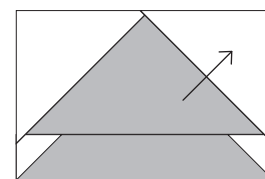
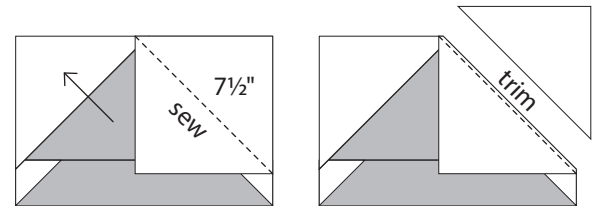
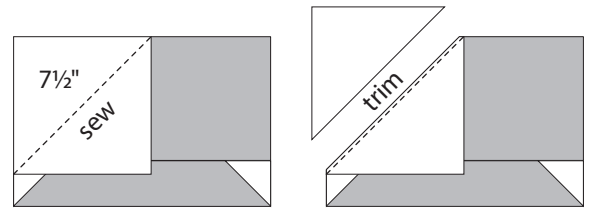

House Roof  
14" x 9 $\frac{1}{4}$ " unfinished  
Make 1.

- (D) Join  $1-3\frac{7}{8}$ " dark pinwheel HST and  $1-3\frac{7}{8}$ " light pinwheel to make 1 half-triangle square (HTS). Make 4. Arrange and sew 2 rows of 2 HTS as shown. Join the rows to make the pinwheel.

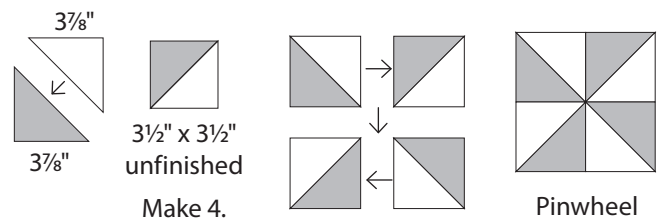

Pinwheel  
6 $\frac{1}{2}$ " x 6 $\frac{1}{2}$ "  
unfinished  
Make 1.

House continued . . .

(E) Assemble the house as shown.

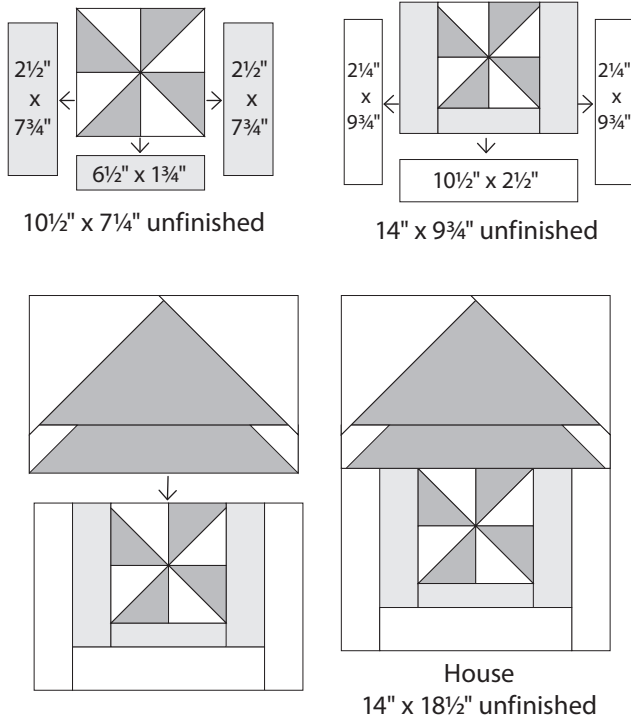

(C) Assemble the tree as shown.

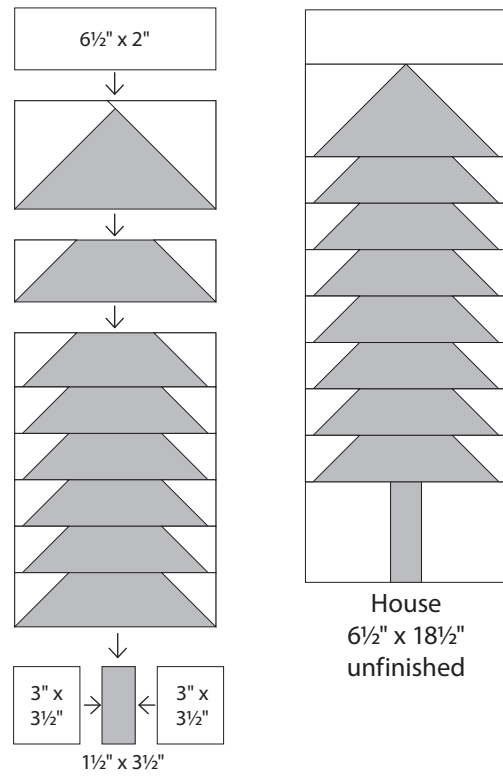

## 2 Tree

(A) Draw a diagonal line from corner to corner on the wrong side of 2–3 1/2" background squares. Layer a 3 1/2" marked background square, right sides to together, on 1–6 1/2" x 3 1/2" tree rectangle as shown. Sew on the diagonal line. Trim 1/4" from the sewn line. Press to reveal the triangle. Repeat on the opposite end of the same rectangle. Make 1.

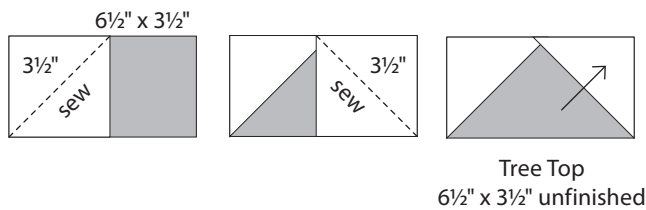

(B) Draw a diagonal line from corner to corner on the wrong side of 14–2" background squares. Layer 2" marked background square, right sides to together, on 1–6 1/2" x 2" tree rectangle as shown. Sew on the diagonal line. Trim 1/4" from the sewn line. Press to reveal the triangle. Repeat on the opposite end of the same rectangle. Make 7.

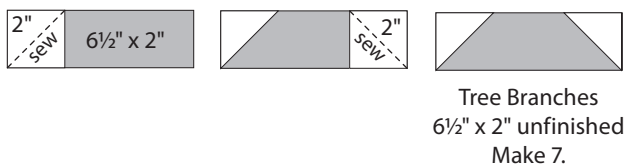

## 3 Assemble the block as shown.

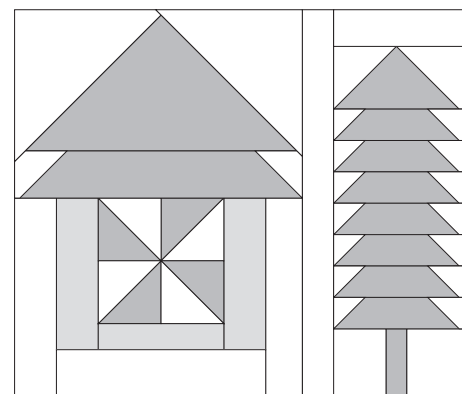
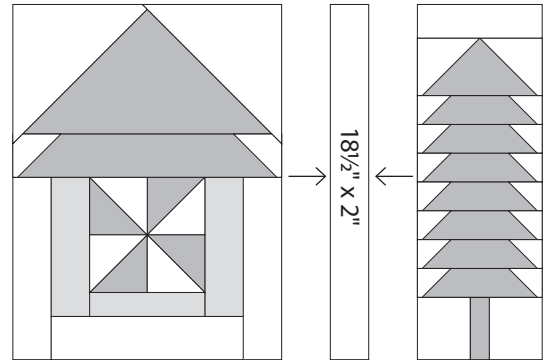

Block 15  
15 1/2" x 18 1/2" unfinished



*moda*

# Be My Neighbor

## Block 16

16½" x 18" finished

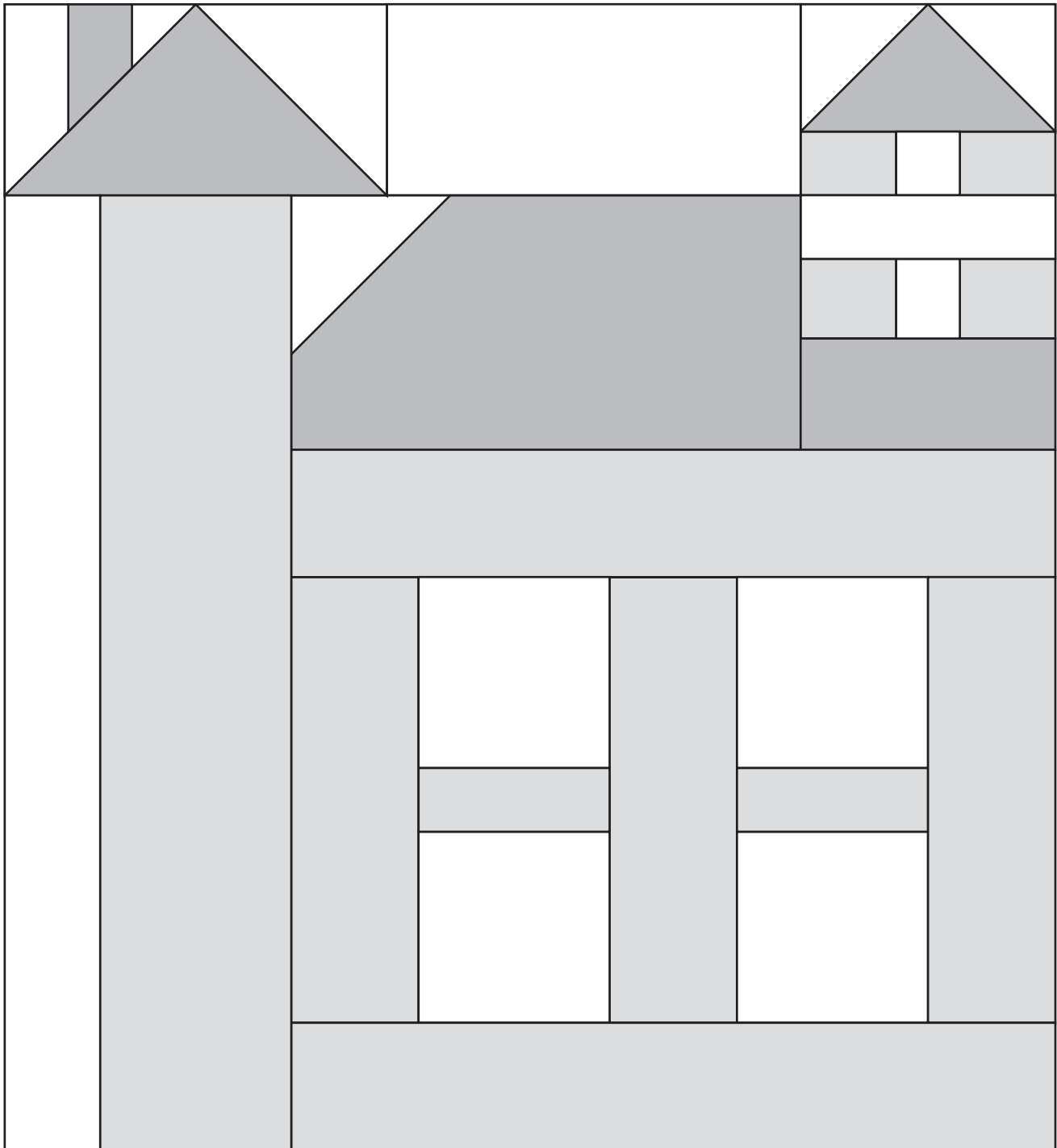

## General Information

- These are very scrappy blocks. Mix your favorite Moda prints to create your colorful neighborhood!
- Share your progress and final quilt at #BeMyNeighbor. We love to see your results!!!

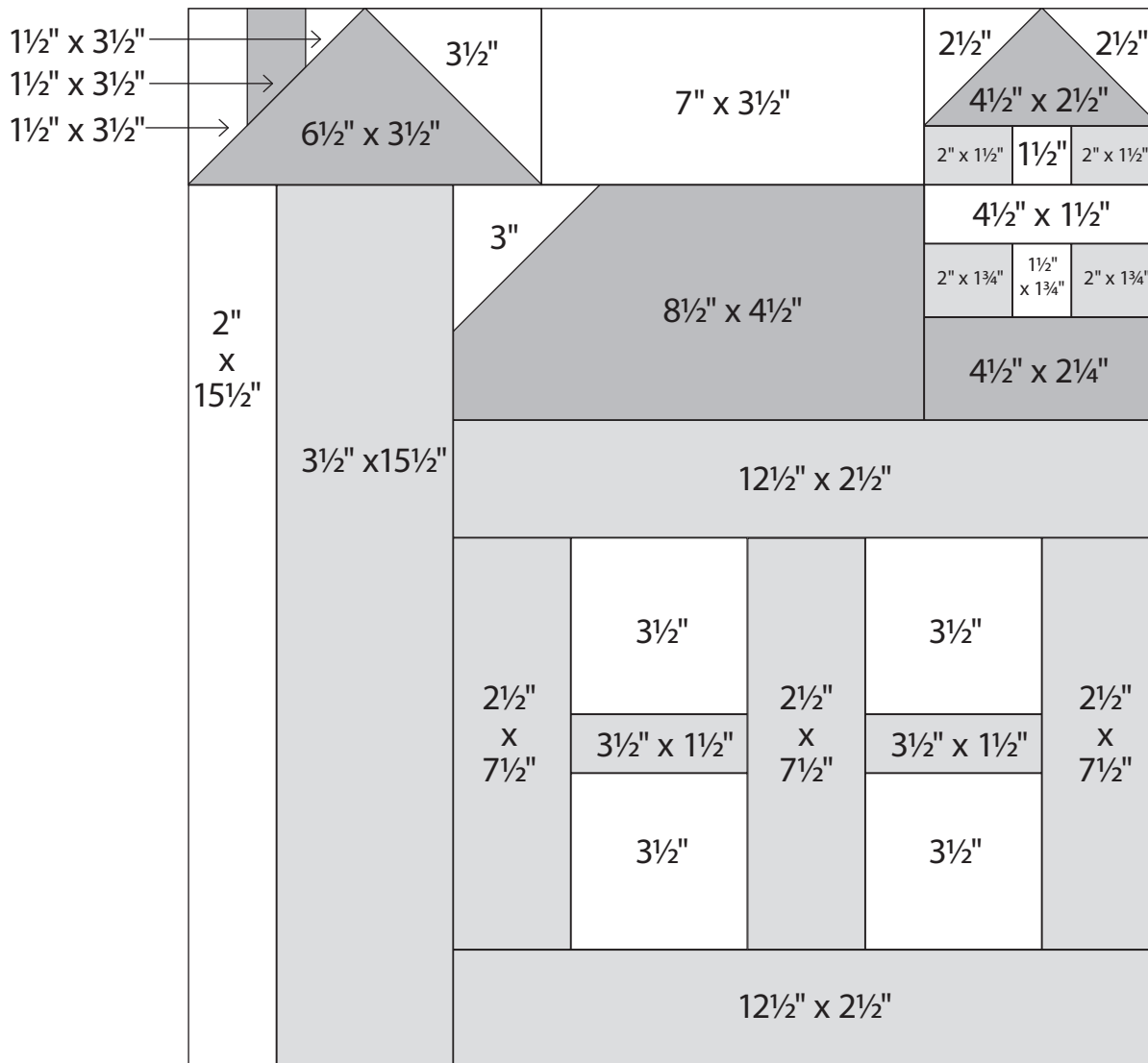

**Block 16**  
17" x 18½" unfinished

## Cutting

### Roof and Chimney

- 1-8½" x 4½" rectangle
- 1-6½" x 3½" rectangle
- 1-4½" x 2¼" rectangle
- 1-1½" x 3½" rectangle

### Roof small

- 1-4½" x 2½" rectangle

### Tower

- 1-3½" x 15½" rectangle

### Windows

- 4-3½" squares

### Cross

- 1-4½" x 1½" rectangle
- 1-1½" x 1¾" rectangle
- 1-1½" square

### House

- 2-12½" x 2½" rectangles
- 2-3½" x 1½" rectangles
- 3-2½" x 7½" rectangles
- 2-2" x 1¾" rectangles
- 2-2" x 1½" rectangles

### Background

- 1-7" x 3½" rectangle
- 1-3½" square
- 1-3" square
- 2-2½" squares
- 1-2" x 15½" rectangle
- 2-1½" x 3½" rectangles



# moda Be My Neighbor

Block 16 is 17" x 18" finished.

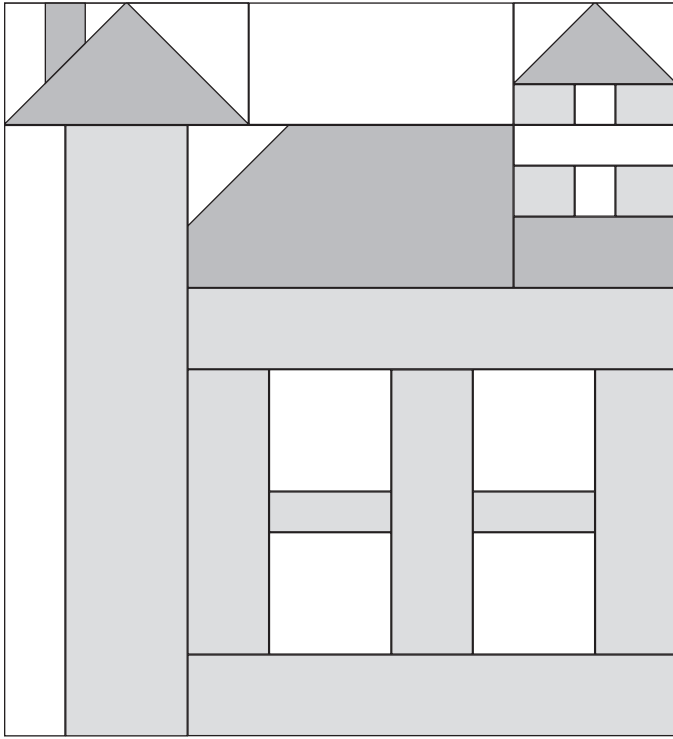

## Construction

Use  $\frac{1}{4}$ " seams. Press in the direction of the arrows in the diagrams.

- 1 Roof**  
 Draw a diagonal line from corner to corner on the wrong side of 2-2½" background squares. Layer a 2½" marked background square, right sides together, on 1-4½" x 2½" roof rectangle as shown. Sew on the diagonal line. Trim  $\frac{1}{4}$ " from the sewn line. Press to reveal the triangle. Repeat on the opposite end of the same rectangle. Make 1.

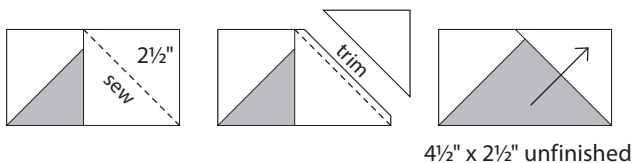
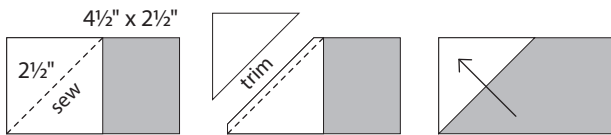

- 2 Roof with Chimney**  
 (A) Join a 2-1½" x 3½" background strips and 1- 1½" x 3½" chimney strip as shown.

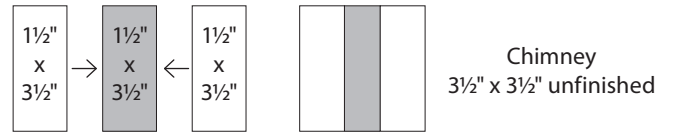

- (B) Draw a diagonal line from corner to corner on the wrong side of the chimney and a 3½" background square as shown. Layer the marked chimney, right sides together, on a 6½" x 3½" roof rectangle as shown. Sew, trim, and press. Repeat using the marked 3½" background square. Make 1.

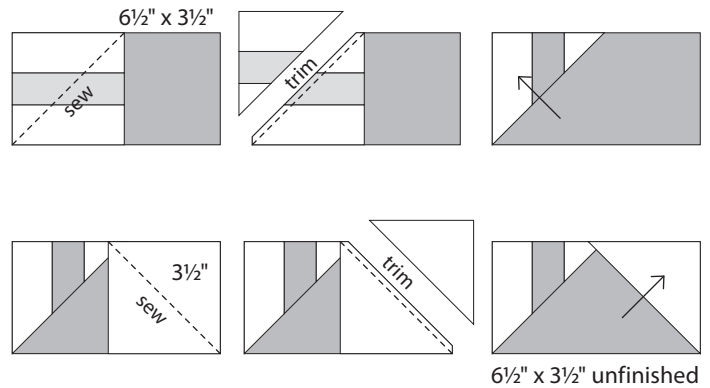

- 3 Assemble the house top row as shown.**

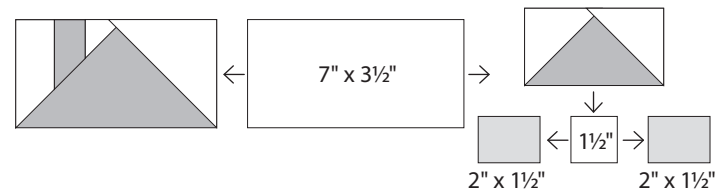

House Top Row  
17" x 3½" unfinished

moda

4 Draw a diagonal line from corner to corner on the wrong side of a 3" background square as shown. Layer the marked square, right sides together, on a 8½" x 4½" roof rectangle as shown. Sew, trim, and press. Add the bottom of the cross as shown.

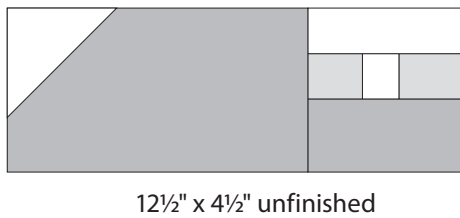
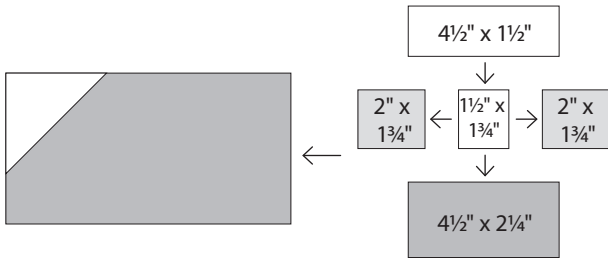
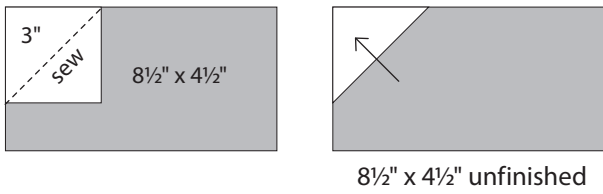

6 Assemble the block as shown.

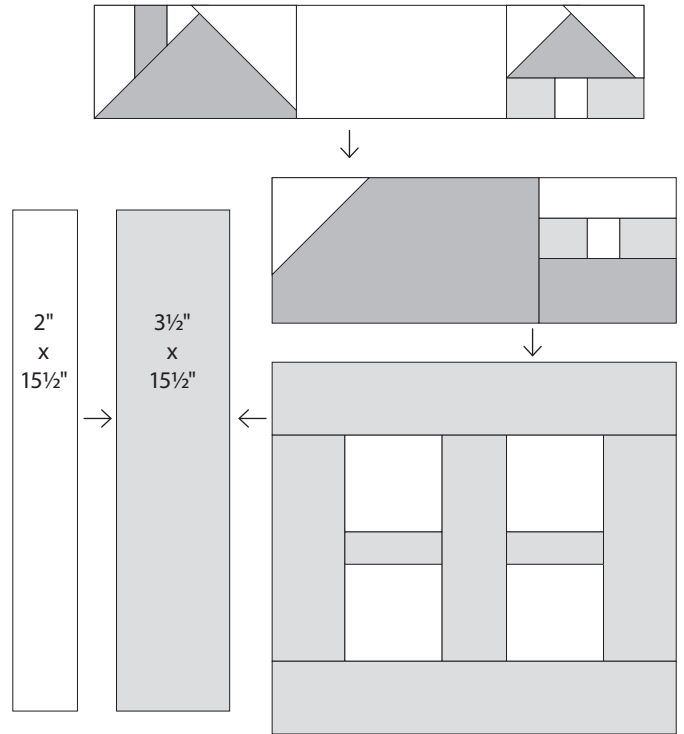

*moda*

5 Assemble the house windows as shown.

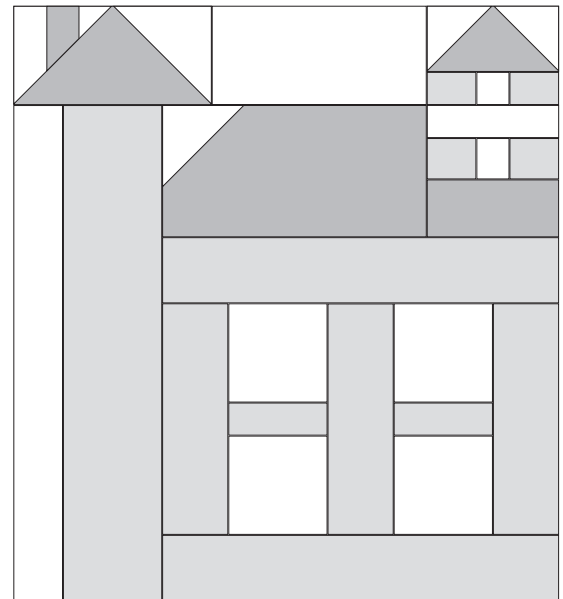
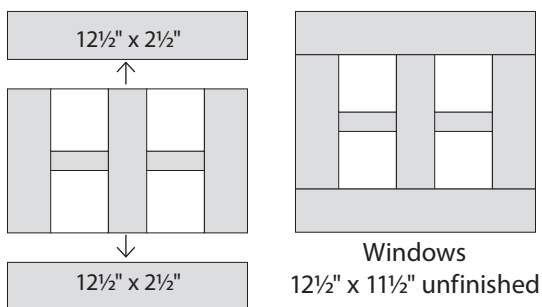
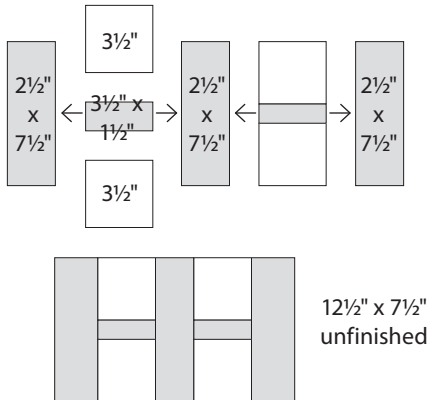

Block 16  
17" x 18½" unfinished