

moda

Be My Neighbor

Block 1
18" x 18" finished

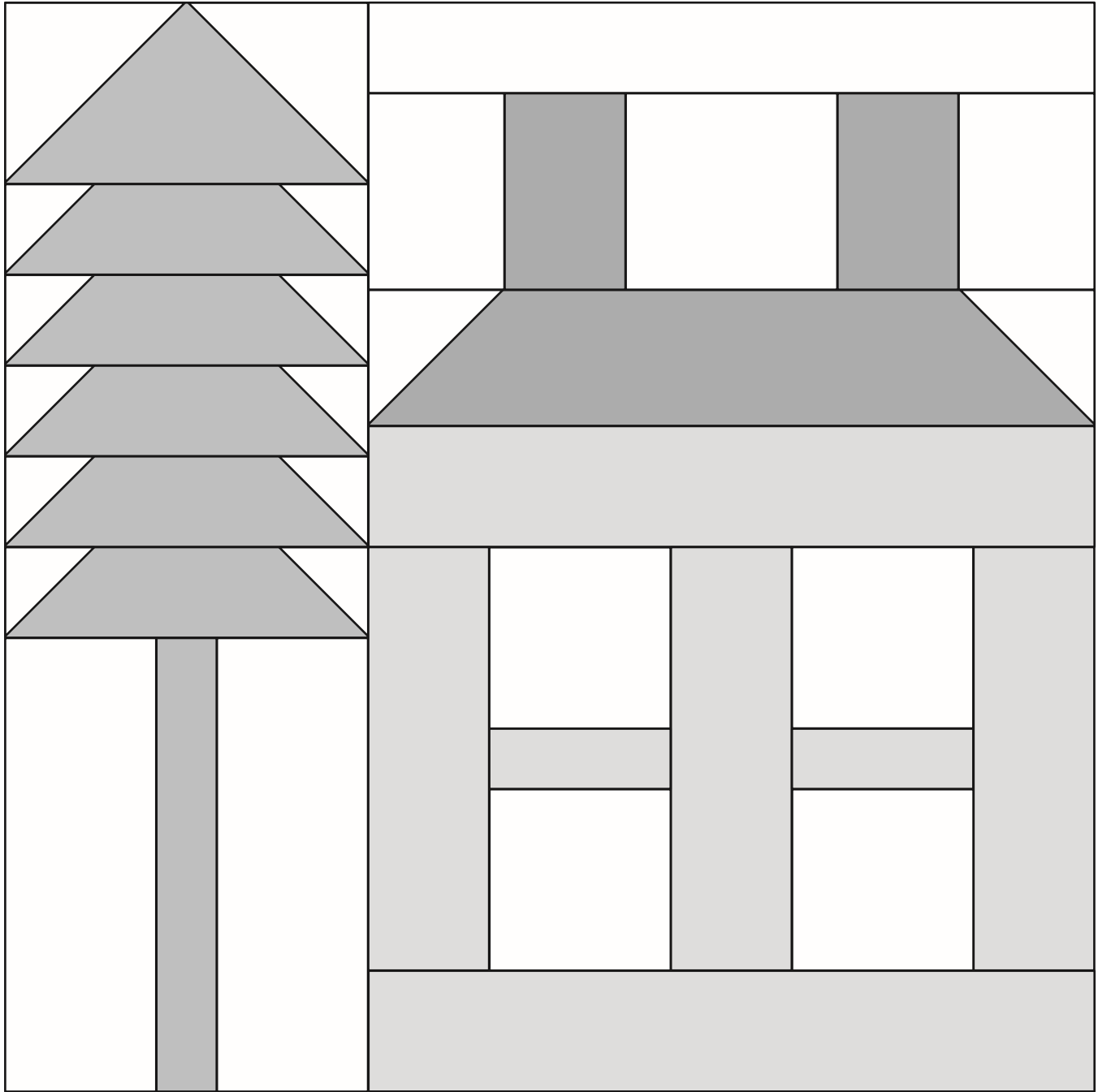

General Information

- These are very scrappy blocks. Mix your favorite Moda prints to create your colorful neighborhood!
- Share your progress and final quilt at #BeMyNeighbor. We love to see your results!!!

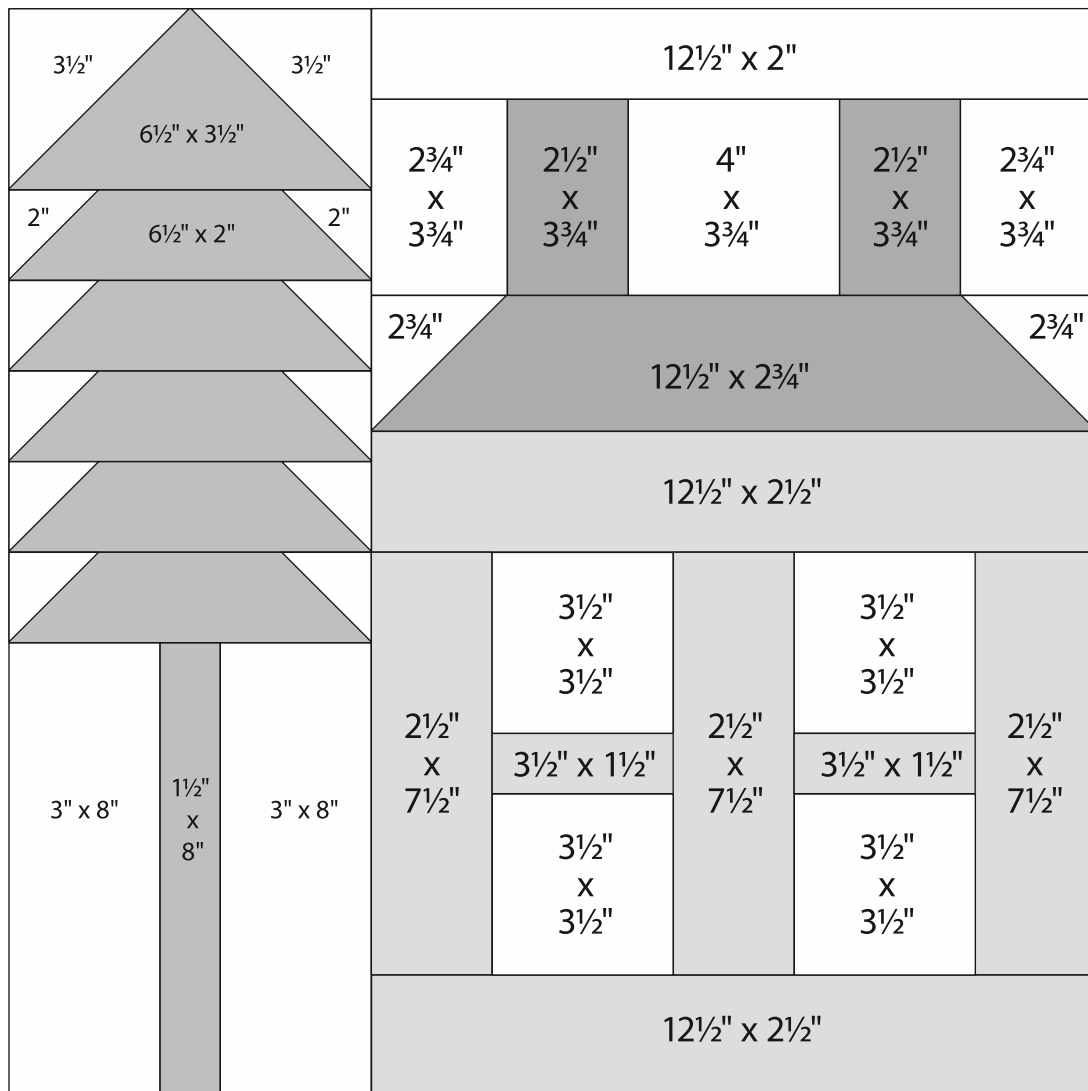

Block 1
18 1/2" x 18 1/2" unfinished

Cutting

House

- 2-12 1/2" x 2 1/2" rectangles
- 2-3 1/2" x 1 1/2" rectangles
- 3-2 1/2" x 7 1/2" rectangles

Windows

- 4-3 1/2" squares

Roof and Chimneys

- 1-12 1/2" x 2 3/4" rectangle
- 2-2 1/2" x 3 3/4" rectangles

Tree

- 1-6 1/2" x 3 1/2" rectangle
- 5-6 1/2" x 2" rectangles

Tree Trunk

- 1-1 1/2" x 8" rectangle

Background

- 10-2" squares
- 1-2" x 12 1/2" rectangle
- 2-2 3/4" squares
- 2-2 3/4" x 3 3/4" rectangles
- 1-3 3/4" x 4" rectangle
- 2-3" x 8" rectangles
- 2-3 1/2" squares



moda Be My Neighbor

Block 1 is 18" x 18" finished.

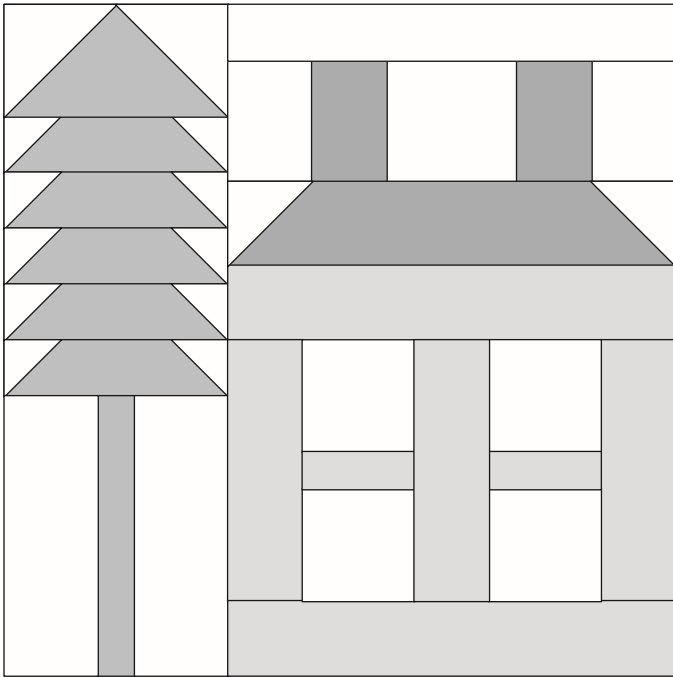

Construction

Use $\frac{1}{4}$ " seams. Press in the direction of the arrows in the diagrams.

1 Tree

(A) Draw a diagonal line from corner to corner on the wrong side of $2-3\frac{1}{2}$ " background squares. Layer a $3\frac{1}{2}$ " marked background square, right sides together, on $1-6\frac{1}{2}$ " x $3\frac{1}{2}$ " tree rectangle as shown. Sew on the diagonal line. Trim $\frac{1}{4}$ " from the sewn line. Press to reveal the triangle. Repeat on the opposite end of the same rectangle. Make 1.

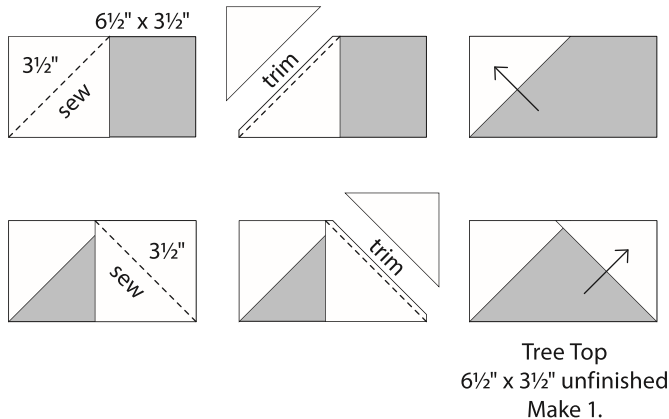

tree continued

(B) Draw a diagonal line from corner to corner on the wrong side of $10-2$ " background squares. Layer 2" marked background square, right sides together, on $1-6\frac{1}{2}$ " x 2 " tree rectangle as shown. Sew on the diagonal line. Trim $\frac{1}{4}$ " from the sewn line. Press to reveal the triangle. Repeat on the opposite end of the same rectangle. Make 5.

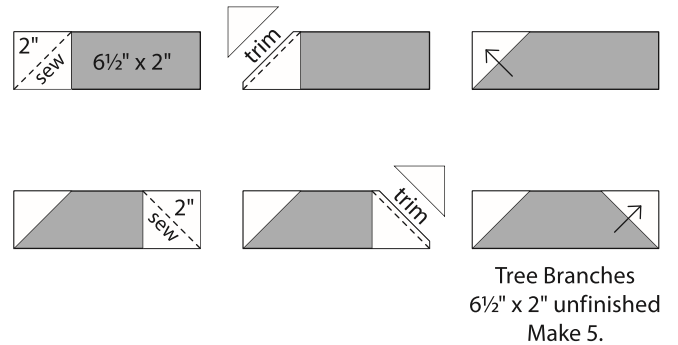

(C) Join $2-3$ " x 8 " background and $1-1\frac{1}{2}$ " x 8 " tree trunk as shown. Make 1.

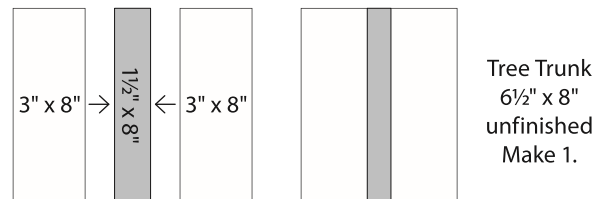

(D) Assemble the tree as shown.

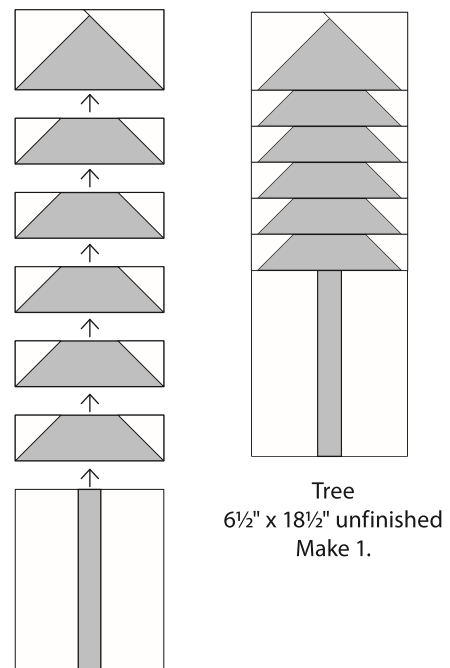

2 Chimney, Roof, and Windows

(A) Join $2-2\frac{3}{4}$ " x $3\frac{3}{4}$ " backgrounds, $2-2\frac{1}{2}$ " x $3\frac{3}{4}$ " chimneys, and $1-4$ " x $3\frac{3}{4}$ " background as shown to make the chimneys.

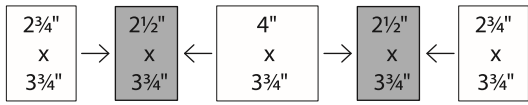

Chimneys
 $18\frac{1}{2}$ " x $3\frac{3}{4}$ " unfinished
Make 1.

(B) Draw a diagonal line from corner to corner on the wrong side of $2-2\frac{3}{4}$ " background squares. Layer a $2\frac{3}{4}$ " marked background square, right sides to together, on $1-12\frac{1}{2}$ " x $2\frac{3}{4}$ " roof rectangle as shown. Sew on the diagonal line. Trim $\frac{1}{4}$ " from the sewn line. Press to reveal the triangle. Repeat on the opposite end of the same rectangle.

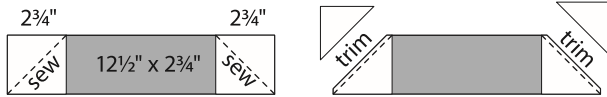

Roof
 $12\frac{1}{2}$ " x $2\frac{3}{4}$ " unfinished
Make 1.

(C) Assemble the windows as shown.

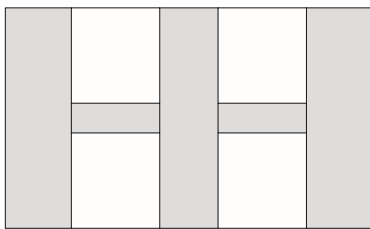
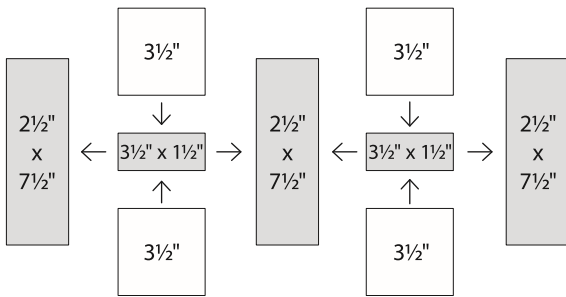

Window
 $12\frac{1}{2}$ " x $7\frac{1}{2}$ " unfinished
Make 1.

3 Assemble the house as shown.

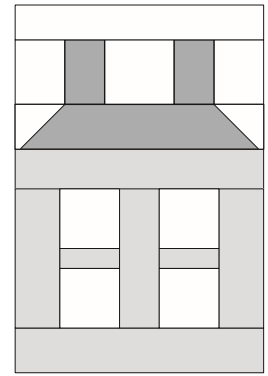
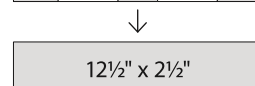
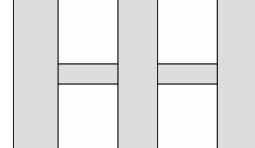
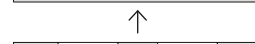
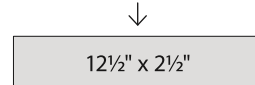
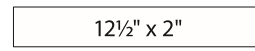

House
 $12\frac{1}{2}$ " x $18\frac{1}{2}$ " unfinished
Make 1.

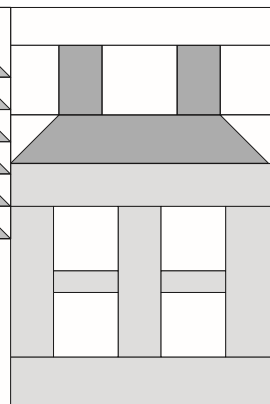
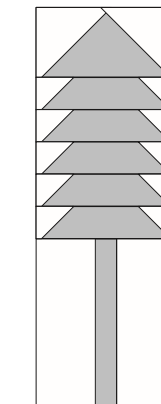
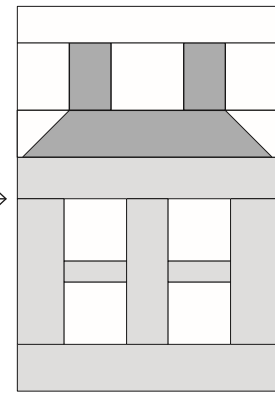
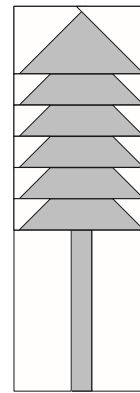

Block 1
 $18\frac{1}{2}$ " x $18\frac{1}{2}$ " unfinished.

moda

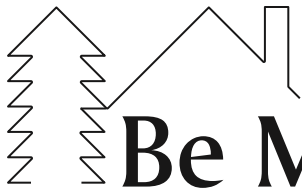

moda

Be My Neighbor

Block 2
15" x 18" finished

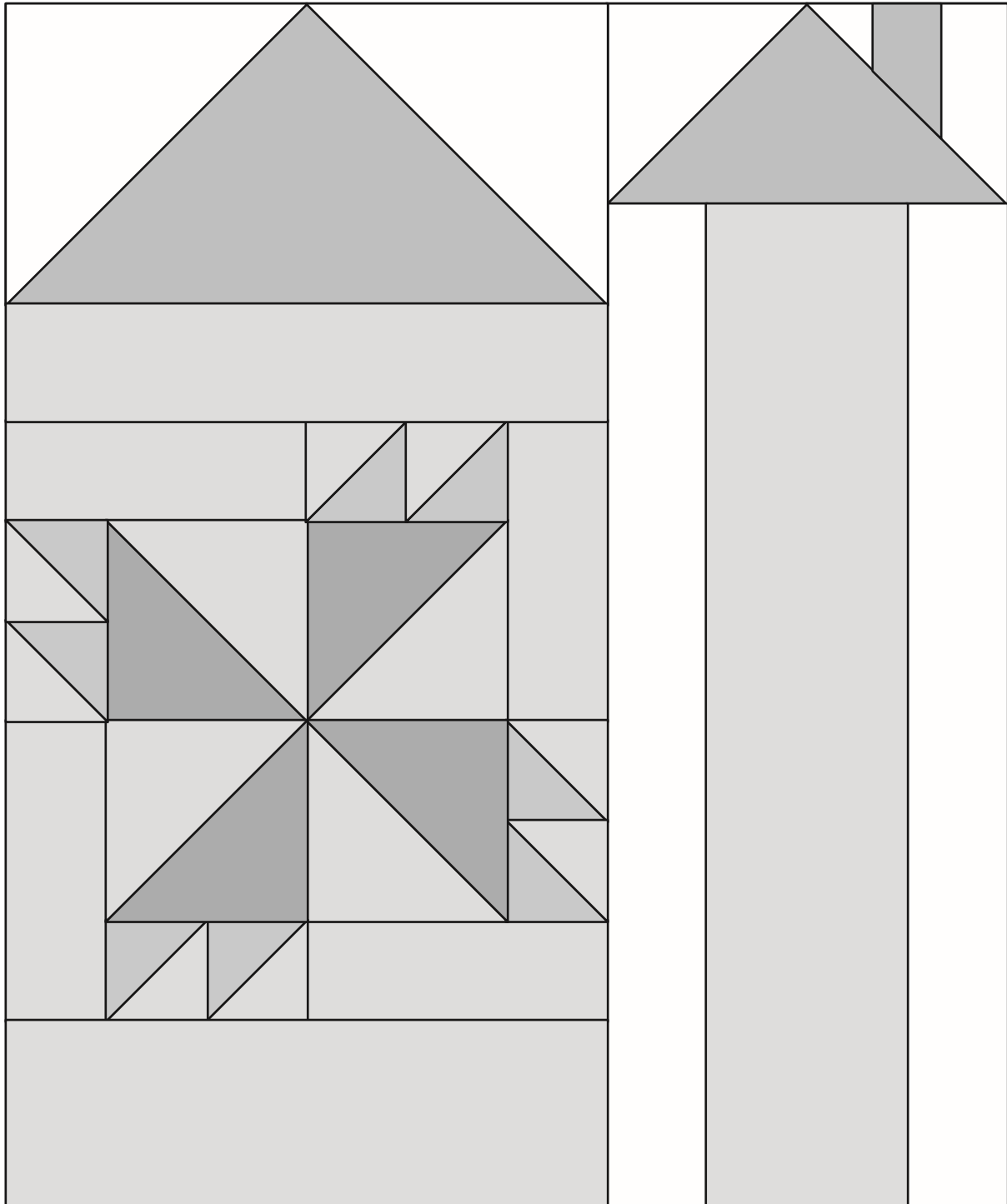

General Information

- These are very scrappy blocks. Mix your favorite Moda prints to create your colorful neighborhood!
- Share your progress and final quilt at #BeMyNeighbor. We love to see your results!!!

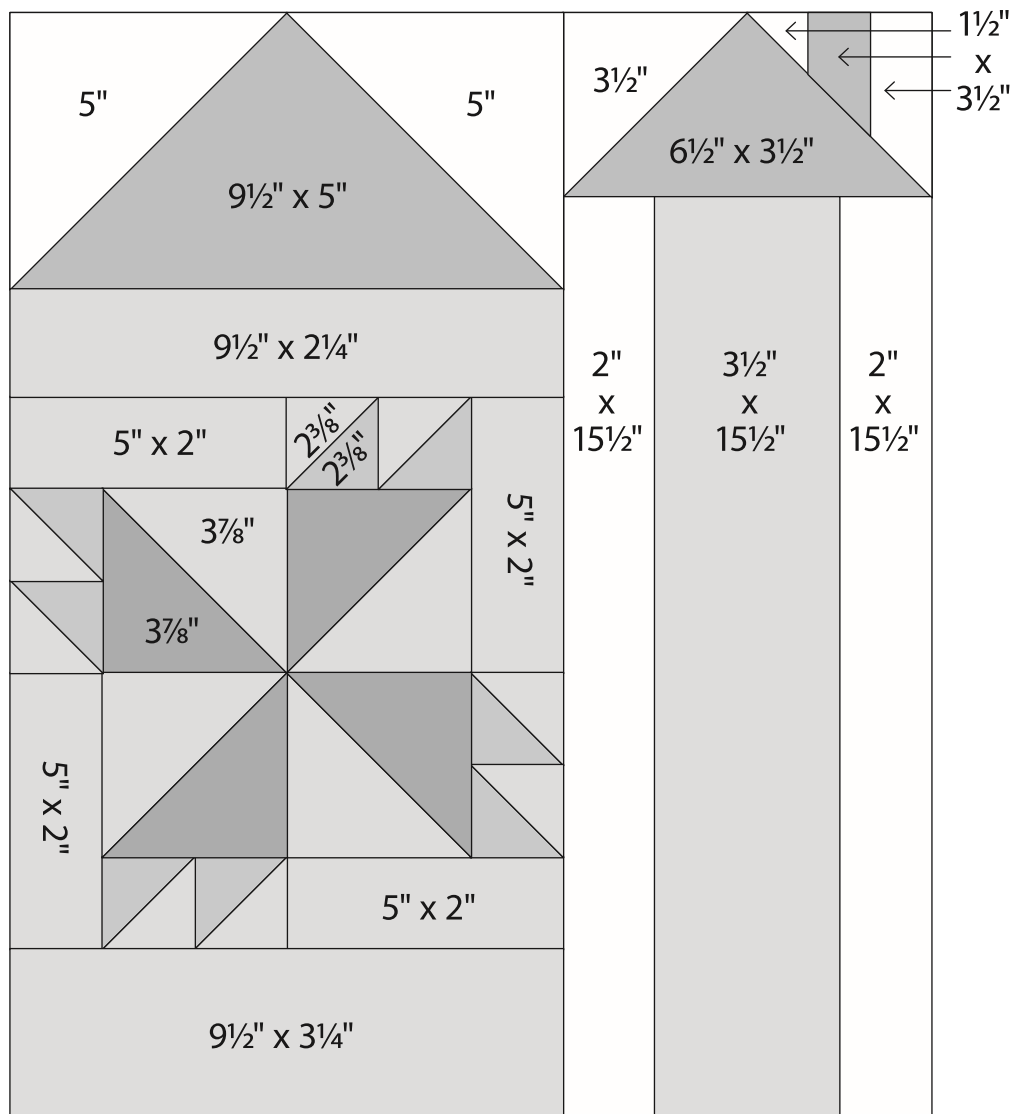

Block 2
15½" x 18½" unfinished

Cutting

House

- 1–9½" x 3¼" rectangle
- 1–9½" x 2¼" rectangle
- 4–5" x 2" rectangles
- 2–3⅞" squares
 - cut in half once on the diagonal to make 4 half-square triangles
- 4–2⅜" squares
 - cut in half once on the diagonal to make 8 half-square triangles

House Roof

- 1–9½" x 5" rectangle

Pinwheel

- 2–3⅞" squares
 - cut in half once on the diagonal to make 4 half-square triangles

Pinwheel Points

- 4–2⅜" squares
 - cut in half once on the diagonal to make 8 half-square triangles

Tower

- 1–3½" x 15½" rectangle

Tower Roof

- 1–6½" x 3½" rectangle

Tower Chimney

- 1–3½" x 1½" rectangle

Background

- 2–5" squares
- 1–3½" square
- 2–3½" x 1½" rectangles
- 2–2" x 15½" rectangles



Be My Neighbor

moda

Block 2 is 15" x 18" finished.

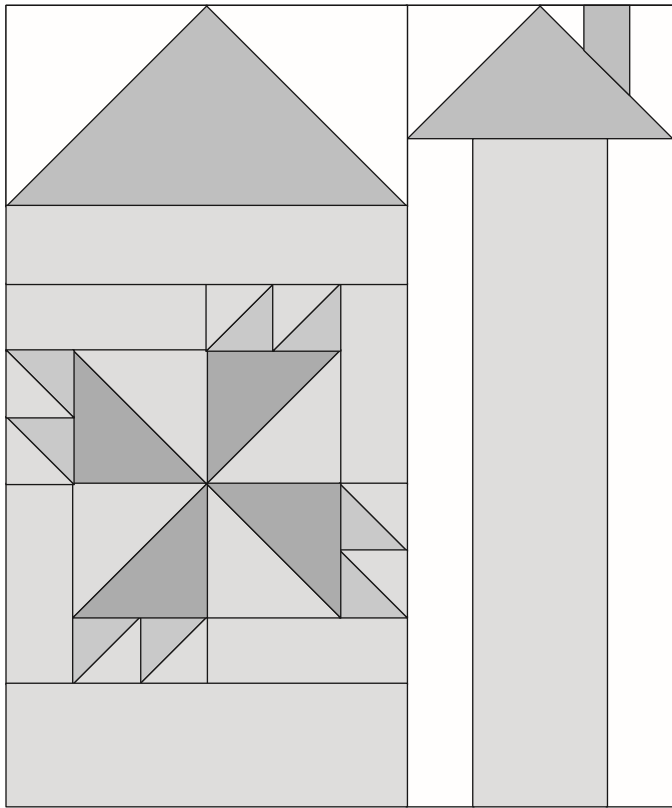

Construction

Use 1/4" seams. Press in the direction of the arrows in the diagrams.

1 House Roof

Draw a diagonal line from corner to corner on the wrong side of 2-5" background squares. Layer a 5" marked background square, right sides to together, on 1-9 1/2" x 5" roof rectangle as shown. Sew on the diagonal line. Trim 1/4" from the sewn line. Press to reveal the triangle. Repeat on the opposite end of the same rectangle. Make 1.

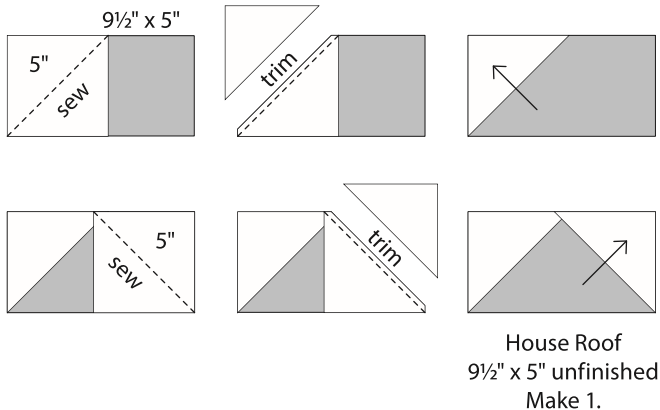

2 Pinwheel with points

(A) Join one 2 3/8" house and one 2 3/8" point half-square triangle to make a 2" point half-triangle square. Make 8. Join 2 HTSs to make 1 point pair. Make 4.

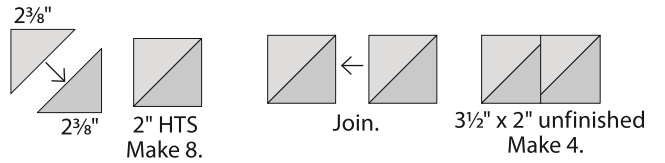

(B) Join one 3 7/8" house and one 3 7/8" pinwheel half-square triangle to make a 3 1/2" pinwheel half-triangle square. Make 4.

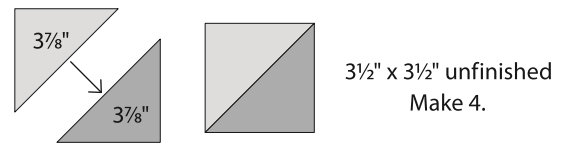

(C) Assemble a pointed pinwheel as shown.

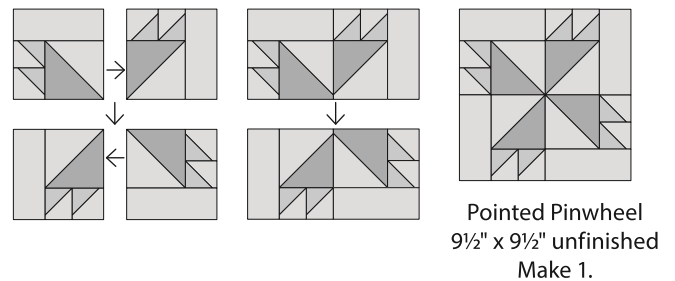
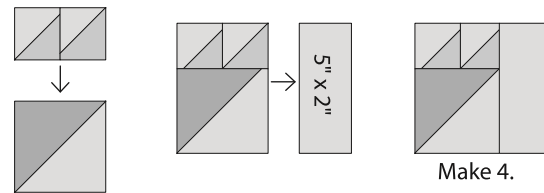

3 Assemble the house as shown.

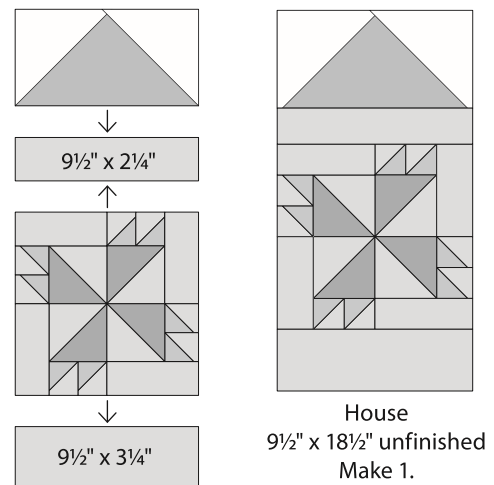

4 Assemble the tower.

(A) Join 2-1½" x 3½" backgrounds and 1-1½" x 3½" chimney to make the chimney.

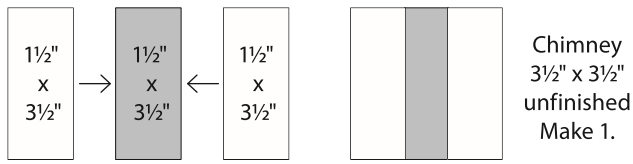

(B) Draw a diagonal line from corner to corner on the wrong side of the chimney square and a 3½" background square. Layer the marked background square, right sides to together, on 1-6½" x 3½" roof rectangle as shown. Sew on the diagonal line. Trim ¼" from the sewn line. Press to reveal the triangle. Repeat on the opposite end of the same rectangle using the marked chimney square. Make 1.

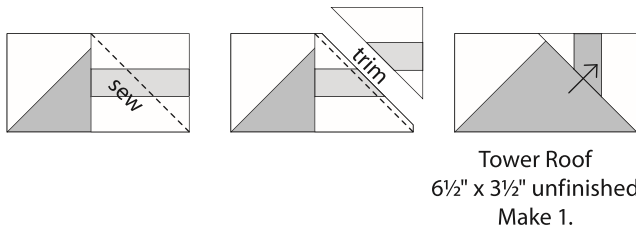
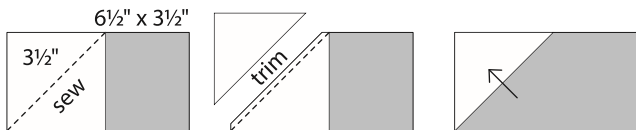

(C) Join 2-2" x 15½" backgrounds and 1-3½" x 15½" tower as shown.

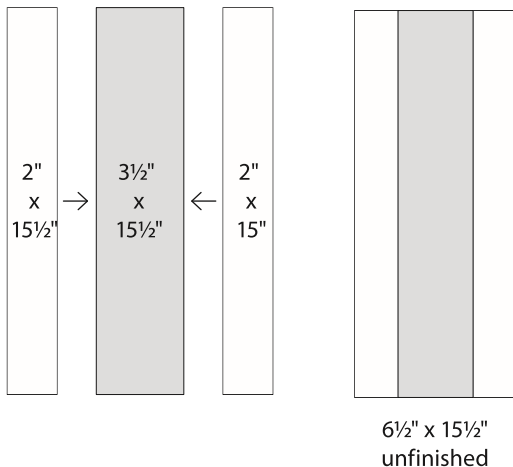

(C) Add the roof to finish the tower.

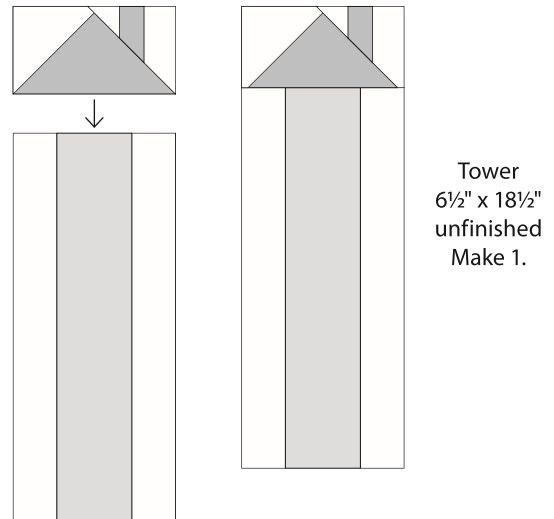

moda

5 Assemble the block as shown.

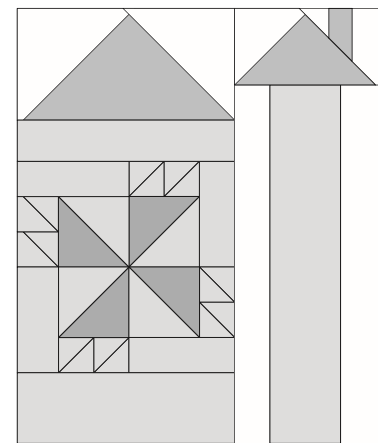
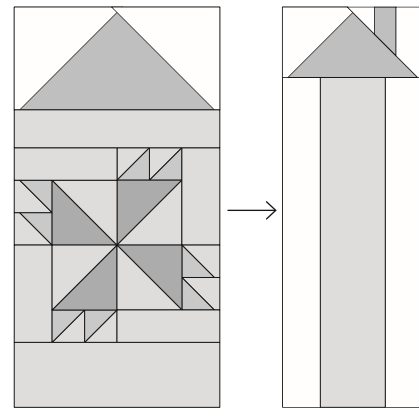

Block 2
15½" x 18½" unfinished

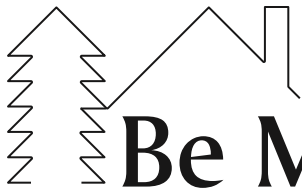

moda

Be My Neighbor

Block 3
15" x 18" finished

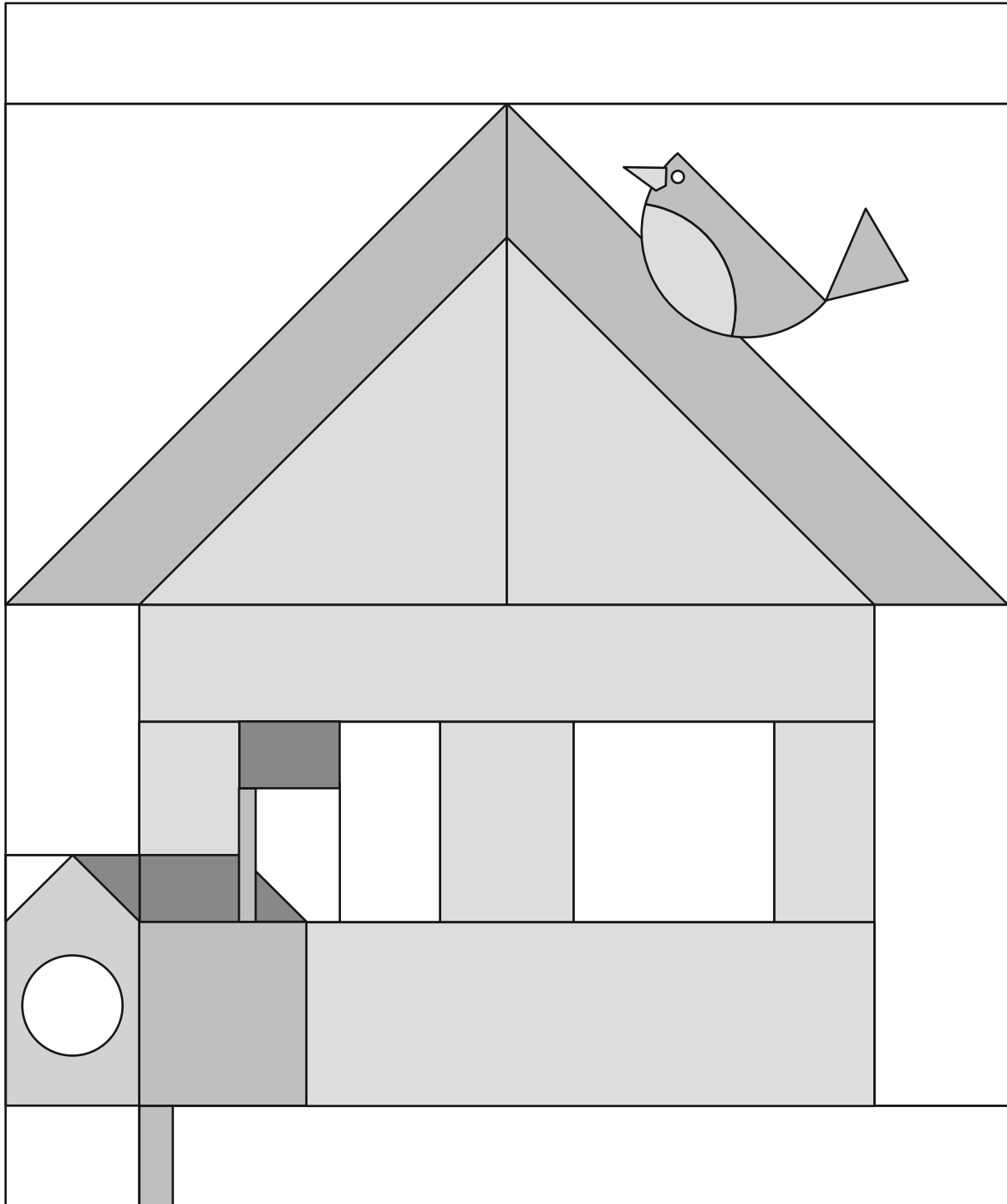

Be My Neighbor

Block 3 is 15" x 18" finished.

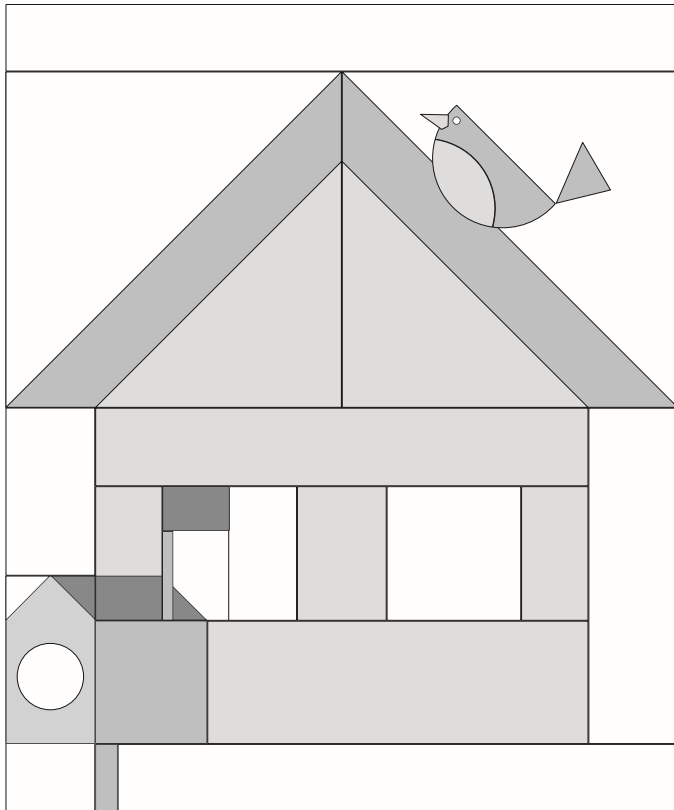

Construction

Use $\frac{1}{4}$ " seams. Press in the direction of the arrows in the diagrams.

1 House Roof

(A) Join one $8\frac{1}{2}$ " roof and one $8\frac{1}{2}$ " background half-square triangle to make one half-triangle square (HTS). Make 2. Trim to 8".

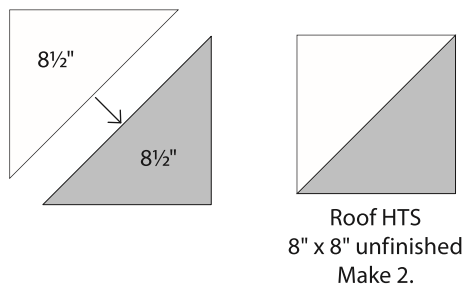

house roof continued . . .

(B) Draw a diagonal line from corner to corner on the wrong side of 2–6" house squares. Layer a marked house square, right sides to together, on a roof HTS as shown. Sew on the diagonal line. Trim the 6" house square only, $\frac{1}{4}$ " from the diagonal line. Press to reveal the triangle. Make 2. Join to make the house roof.

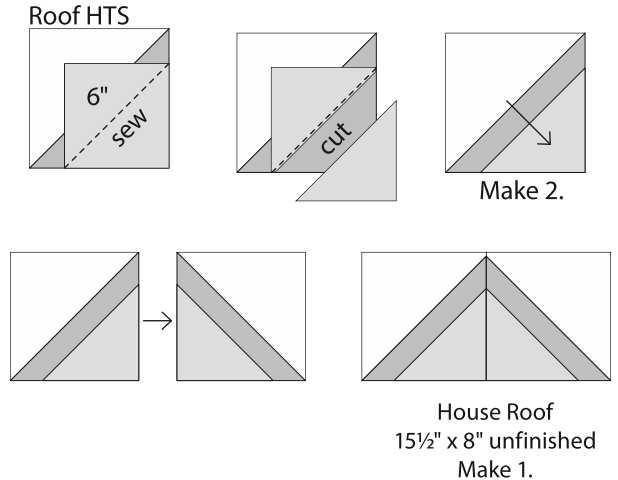

2 Mailbox

Draw a diagonal line from corner to corner on the wrong side of 1–1 $\frac{1}{2}$ " background and 1–1 $\frac{1}{2}$ " mailbox roof squares. Layer a marked background square, right sides to together, on the 2 $\frac{1}{2}$ " x 4 $\frac{1}{4}$ " mailbox front as shown. Sew on the diagonal line. Trim $\frac{1}{4}$ " from the diagonal line. Press to reveal the triangle. Repeat using the marked 1 $\frac{1}{2}$ " mailbox square on the opposite corner as shown. Appliqué the circle to the front. Add a 2 $\frac{1}{2}$ " x 4 $\frac{1}{4}$ " background rectangle as shown.

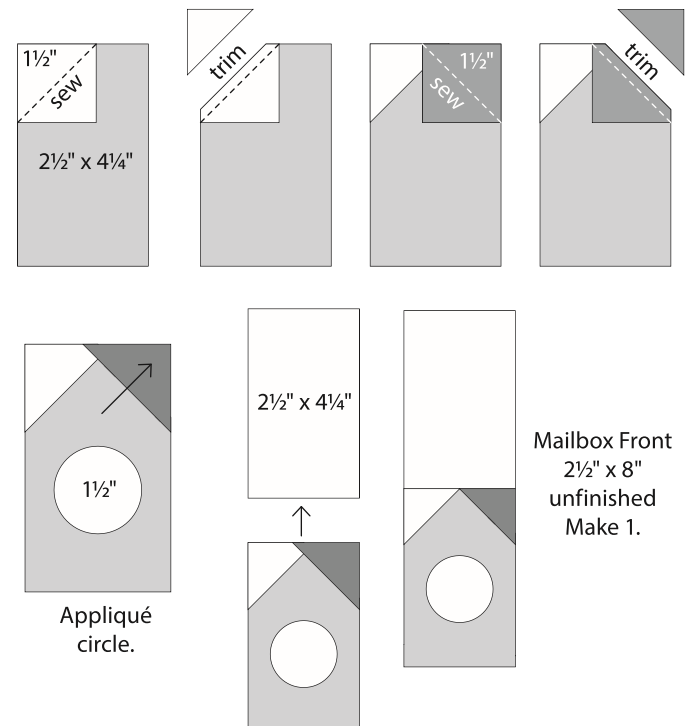

3 Mailbox Flag and House Windows

Draw a diagonal line from corner to corner on the wrong side of 1-1/4" mailbox roof square. Layer the marked square, right sides to together, on the 1 3/4" x 2 1/2" window as shown. Sew on the diagonal line. Trim 1/4" from the diagonal line. Press to reveal the triangle.

Follow the steps to assemble the mailbox flag and house windows.

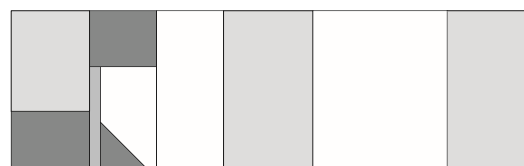
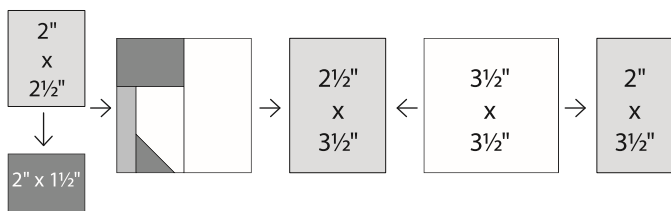
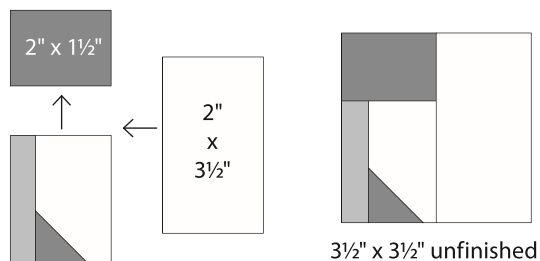
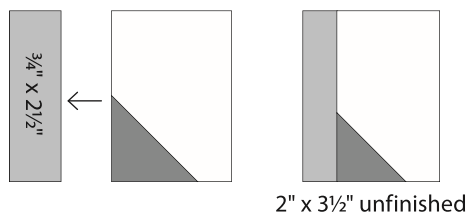
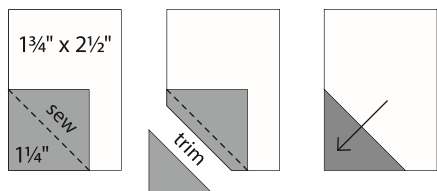

Mailbox Flag and House Windows
1 1/2" x 3 1/2" unfinished

4 Assemble the block.

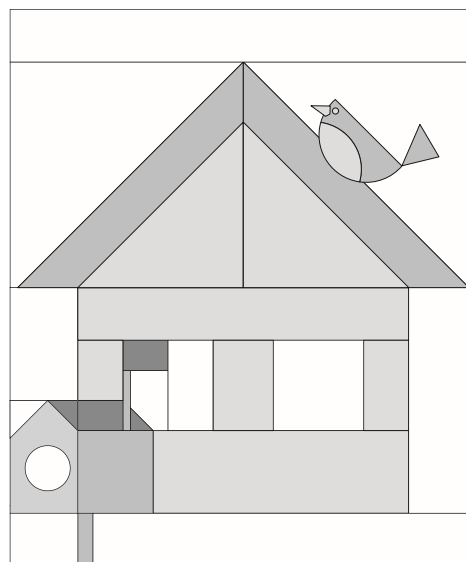
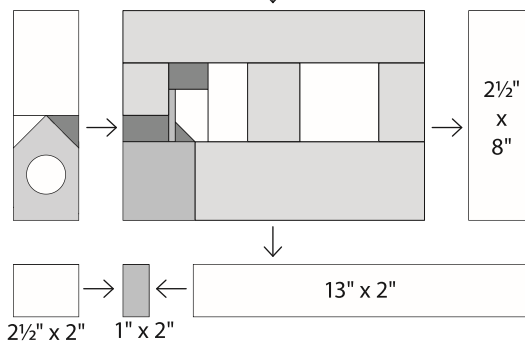
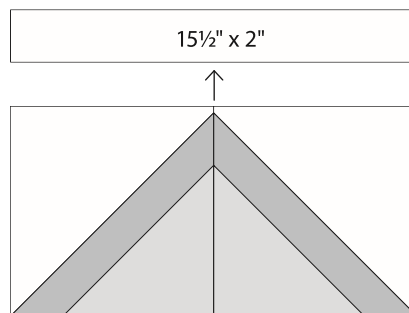
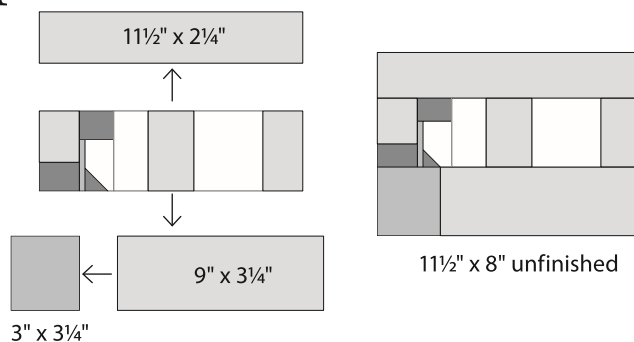

Block 3
15 1/2" x 18 1/2" unfinished

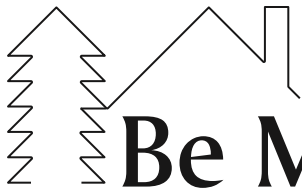

moda

Be My Neighbor

Block 4

12" x 18" finished

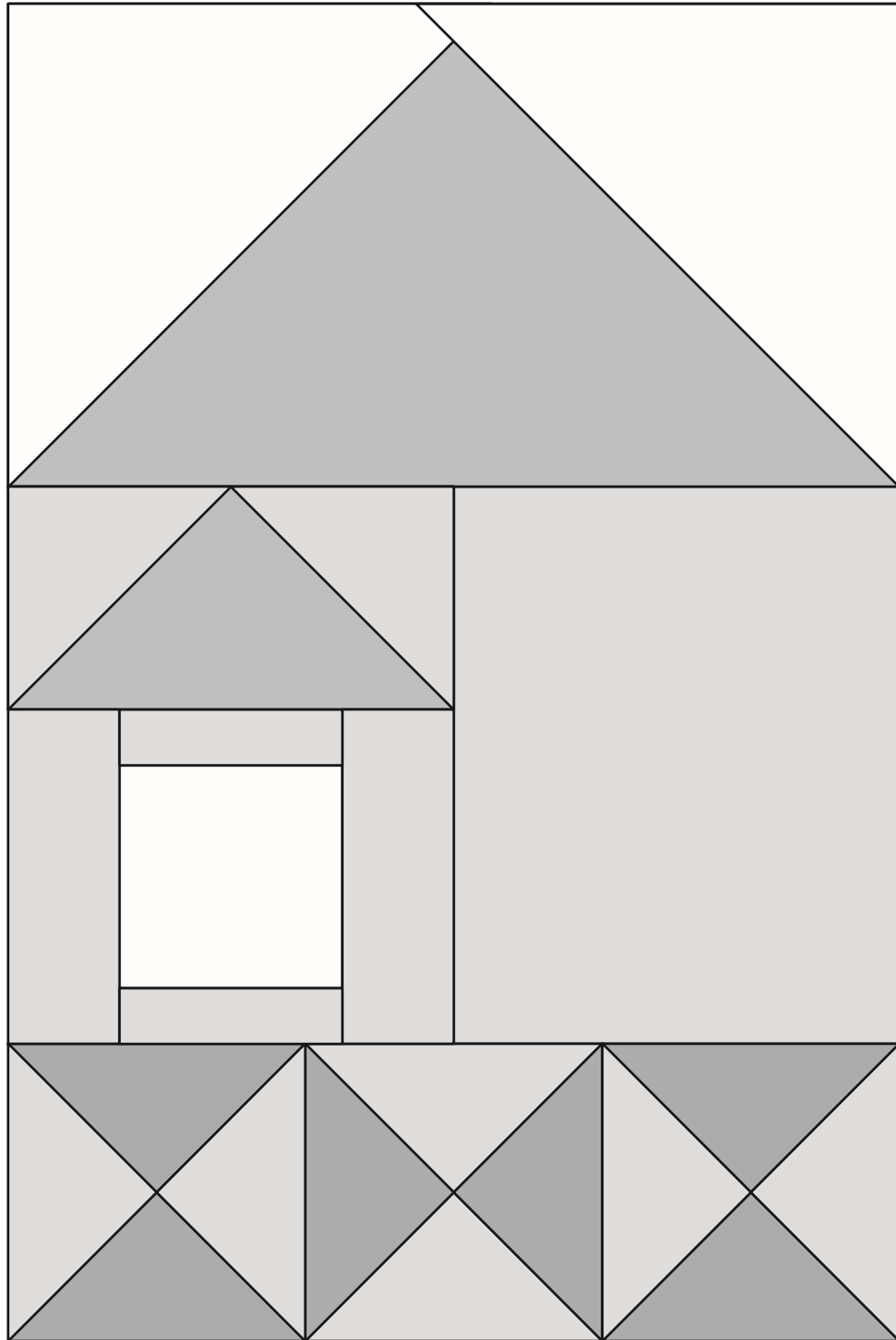

General Information

- These are very scrappy blocks. Mix your favorite Moda prints to create your colorful neighborhood!
- Share your progress and final quilt at #BeMyNeighbor. We love to see your results!!!

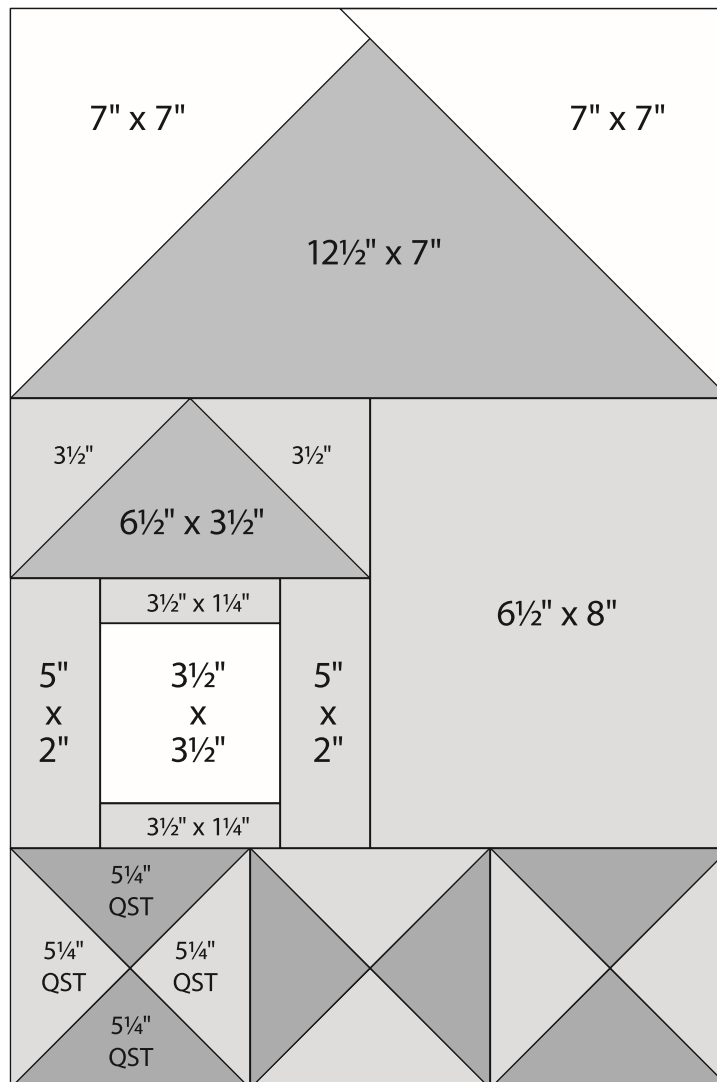

Block 4
12½" x 18½" unfinished

Cutting

House Roof Large

1–12½" x 7" rectangle

House Roof Small

1–6½" x 3½" rectangle

Quarter-Square Triangles

2–5¼" squares

cut in half twice on the diagonal to
make 8 quarter-square triangles (need 6)

House

1–6½" x 8" rectangle

2–5¼" squares

cut in half twice on the diagonal to
make 8 quarter-square triangles (need 6)

2–5" x 2" rectangles

2–3½" squares

2–3½" x 1¼" rectangles

Window

1–3½" square

Background

2–7" squares



Be My Neighbor

Block 4 is 12" x 18" finished.

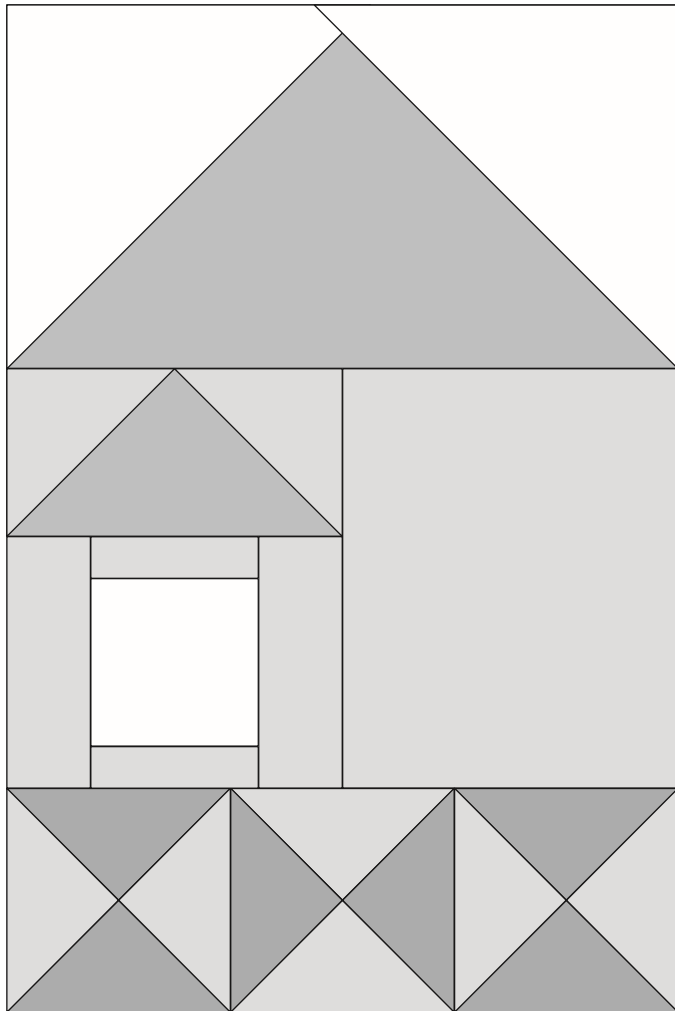

moda

Construction

Use ¼" seams. Press in the direction of the arrows in the diagrams.

1 House Roof Large

Draw a diagonal line from corner to corner on the wrong side of 2-7" background squares. Layer a 7" marked background square, right sides to together, on 1-12½" x 7" large roof rectangle as shown. Sew on the diagonal line. Trim ¼" from the sewn line. Press to reveal the triangle. Repeat on the the opposite end of the same rectangle. Make 1.

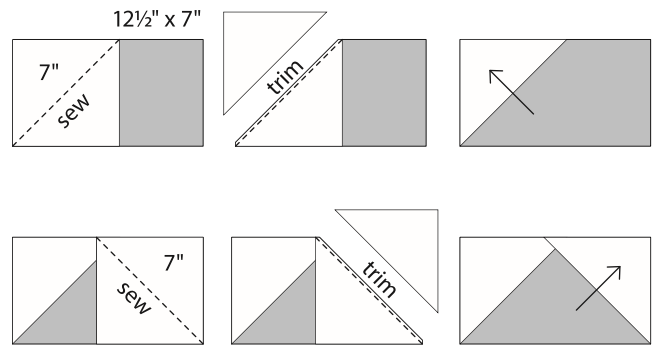

House Roof Large
12½" x 7" unfinished
Make 1.

2 House Roof Small

Draw a diagonal line from corner to corner on the wrong side of 2-3½" house squares. Layer a 3½" marked house square, right sides to together, on 1-6½" x 3½" small roof rectangle as shown. Sew on the diagonal line. Trim ¼" from the sewn line. Press to reveal the triangle. Repeat on the the opposite end of the same rectangle. Make 1.

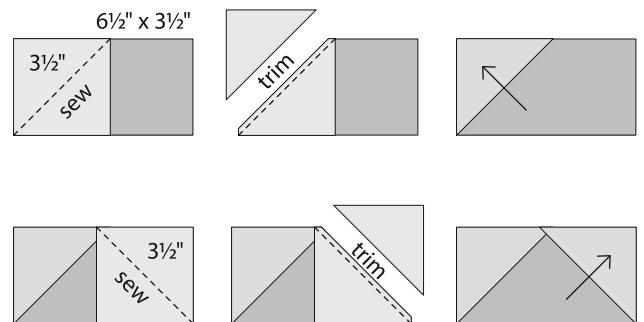

House Roof Small
6½" x 3½" unfinished
Make 1.

3 Assemble the window section as shown.

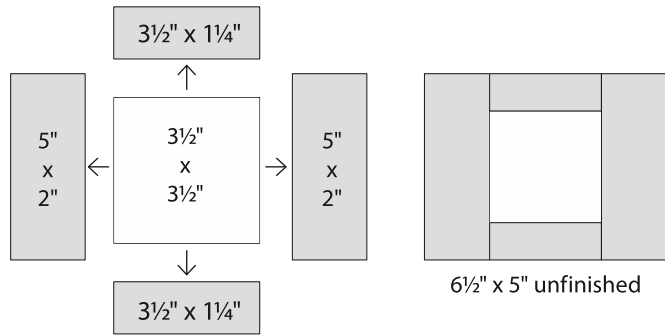

House Roof Small

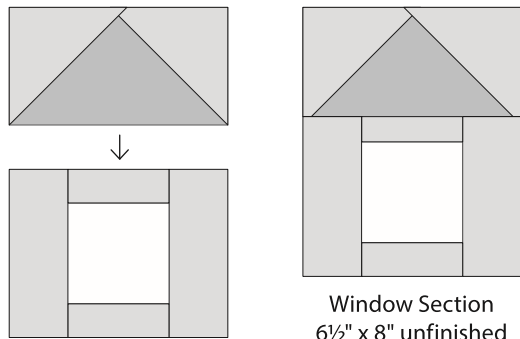

Window Section
6 1/2" x 8" unfinished
Make 1.

4 House Base

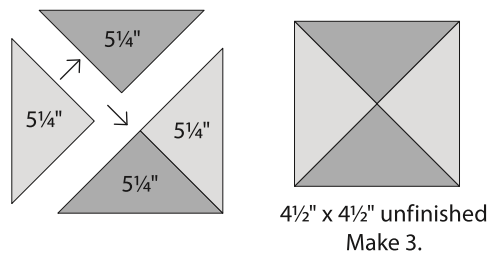

4 1/2" x 4 1/2" unfinished
Make 3.

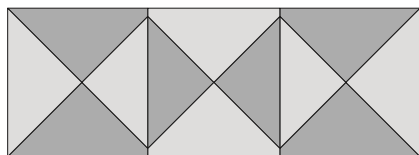
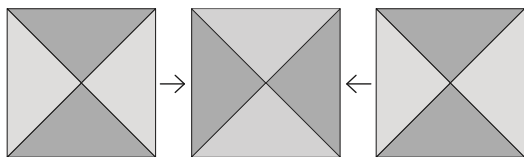

House Base
12 1/2" x 4 1/2" unfinished
Make 1.

5 Assemble the block as shown.

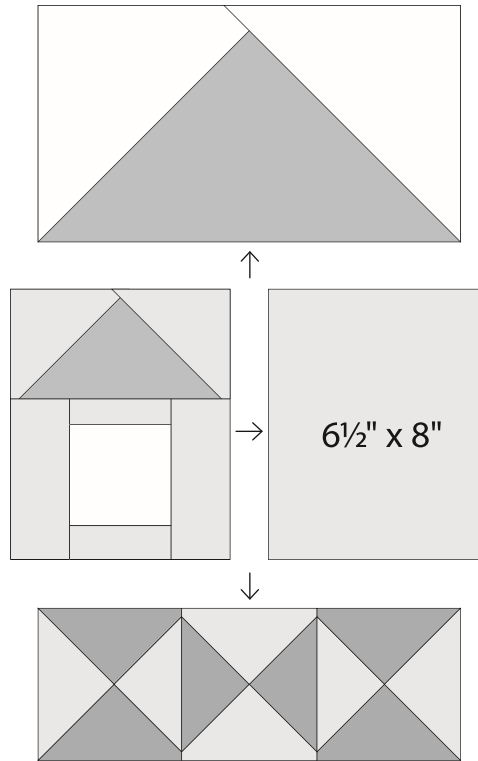

6 1/2" x 8"

moda

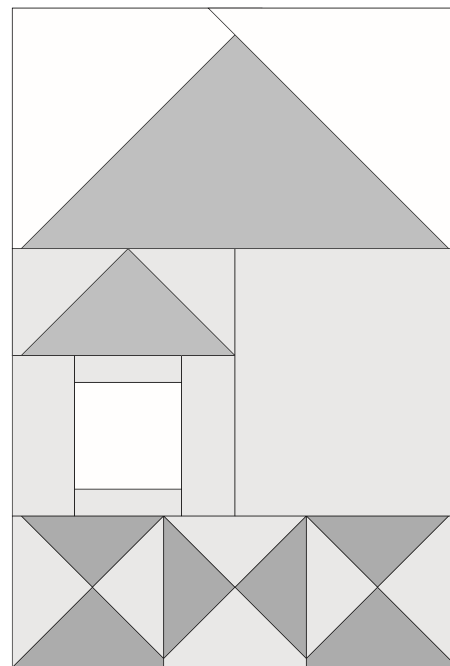

Block 4
12 1/2" x 18 1/2" unfinished
Make 1.

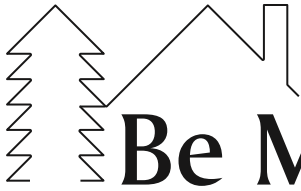

moda

Be My Neighbor

Block 5

12" x 18" finished

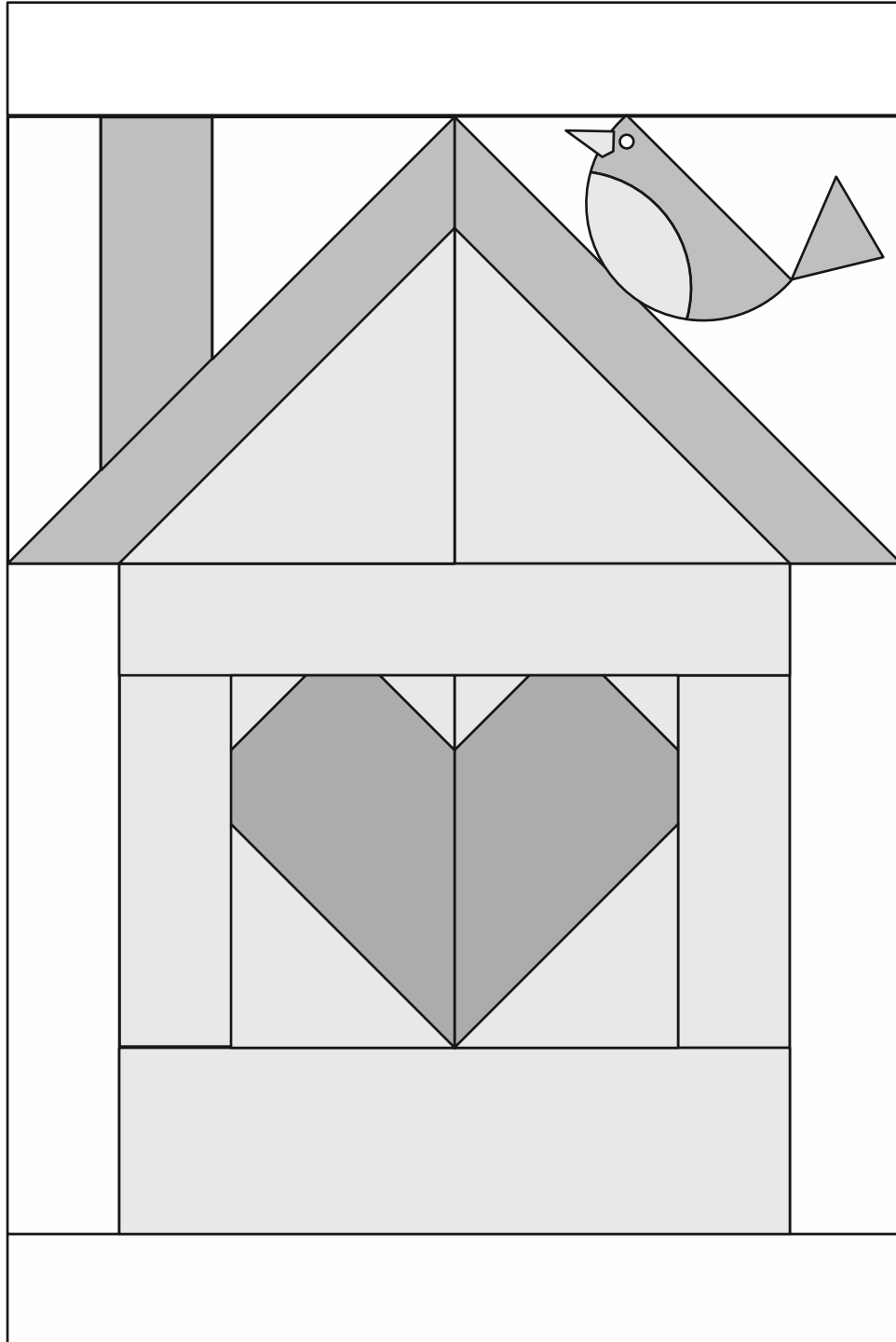

General Information

- These are very scrappy blocks. Mix your favorite Moda prints to create your colorful neighborhood!
- Share your progress and final quilt at #BeMyNeighbor. We love to see your results!!!

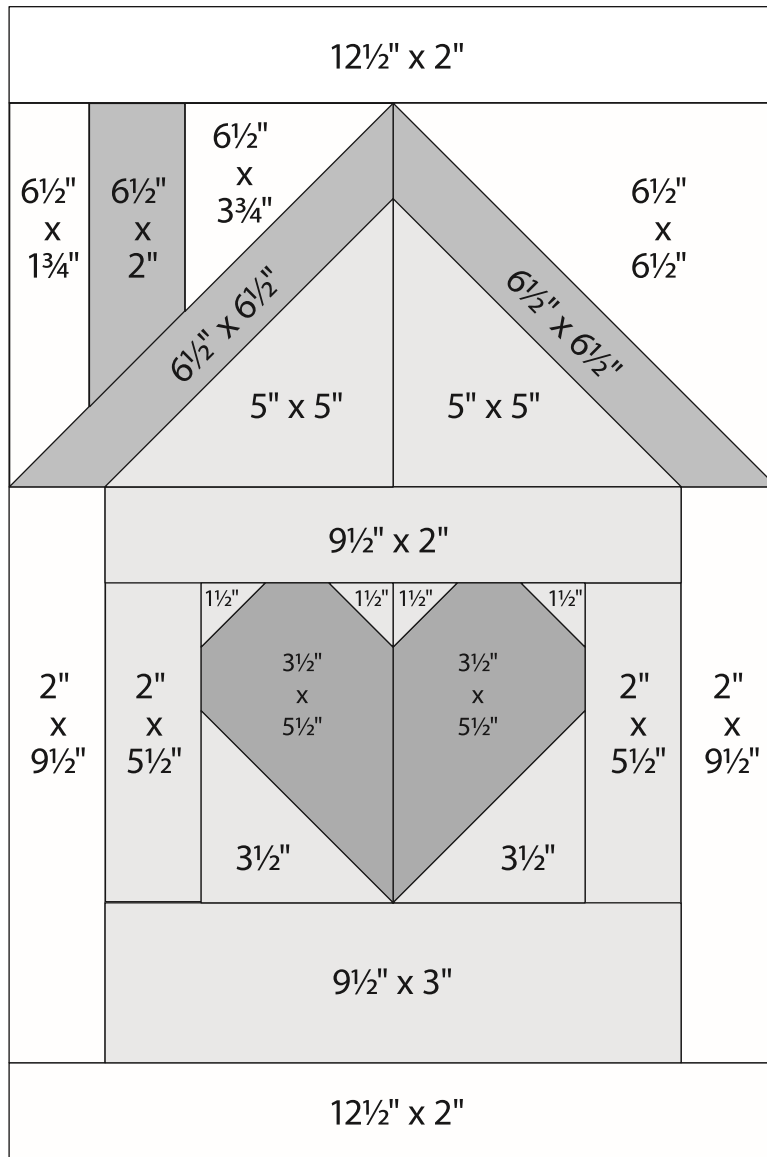

Block 5
12½" x 18½" unfinished

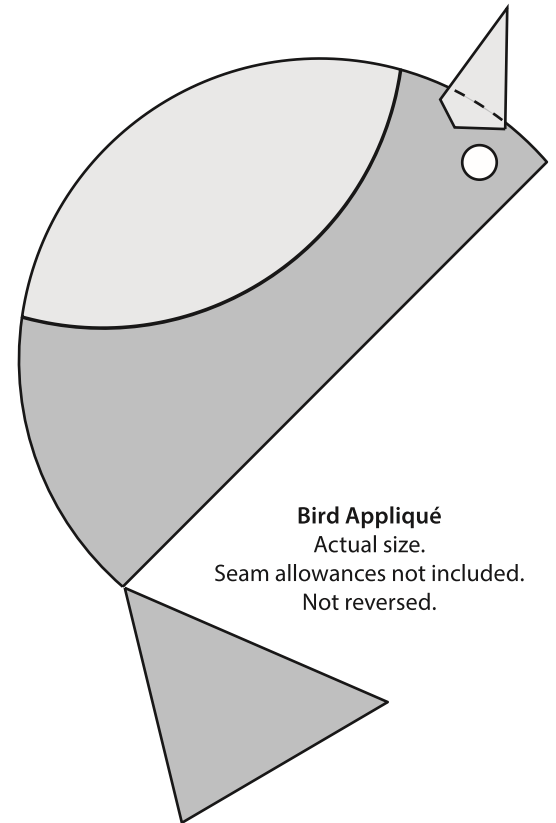

Bird Appliqué
Actual size.
Seam allowances not included.
Not reversed.

Cutting

House

- 1–9½" x 3" rectangles
- 1–9½" x 2" rectangles
- 2–5½" x 2" rectangles
- 2–5" squares
- 2–3½" squares
- 4–1½" squares

Roof: 2–6½" squares

Chimney: 1–2" x 6½"

Heart: 2–3½" x 5½"

Background

- 1–6½" square
- 1–6½" x 3¾" rectangle
- 1–6½" x 1¾" rectangle
- 2–2" x 12½" rectangles
- 2–2" x 9½" rectangles

Bird Appliqué

- 1–beak
- 1–body
- 1–tail
- 1–wing
- 1–eye



moda Be My Neighbor

Block 5 is 12" x 18" finished.

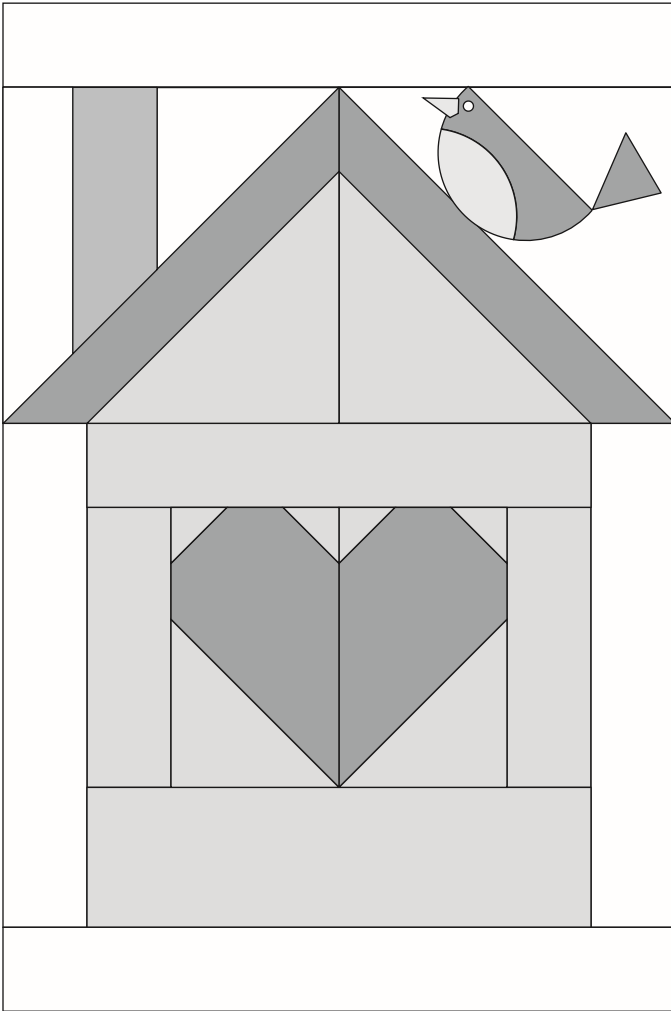

Construction

Use $\frac{1}{4}$ " seams. Press in the direction of the arrows in the diagrams.

1 Roof

- (A) Join a $1\frac{3}{4}$ " x $6\frac{1}{2}$ " background, 2" x $6\frac{1}{2}$ " chimney, and $3\frac{3}{4}$ " x $6\frac{1}{2}$ " background strip as shown.

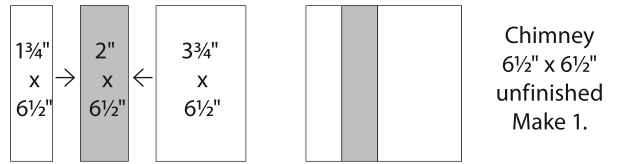

- (B) Draw a diagonal line from corner to corner on the wrong side of 2–5" house squares. Layer a 5" marked background square, right sides to together, on 1– $6\frac{1}{2}$ " roof square as shown. Sew on the diagonal line. Trim $\frac{1}{4}$ " from the sewn line. Press to reveal the triangle. Make 2.

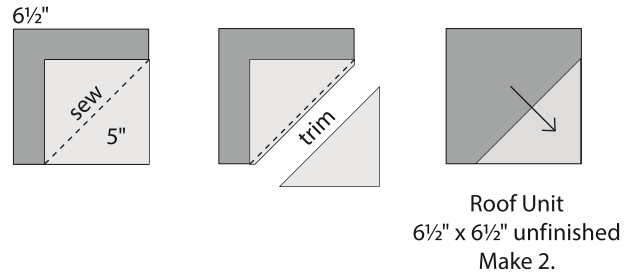

- (C) Draw a diagonal line from corner to corner on the wrong side of the chimney as shown. Layer the marked chimney, right sides together, on a roof unit as shown. Sew, trim, and press. Make 1.

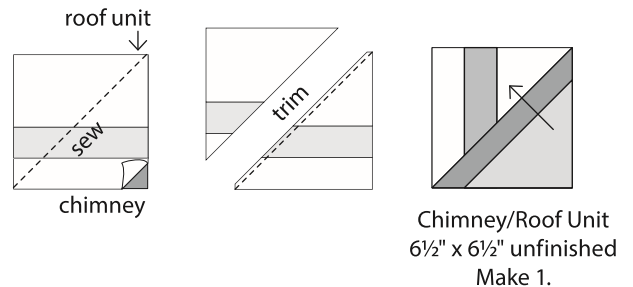

moda

(D) Draw a diagonal line from corner to corner on the wrong side of a 6½" background square. Layer the marked square, right sides together, on a roof unit as shown. Sew, trim, and press to reveal the triangle. Make 1. Join units to make the roof.

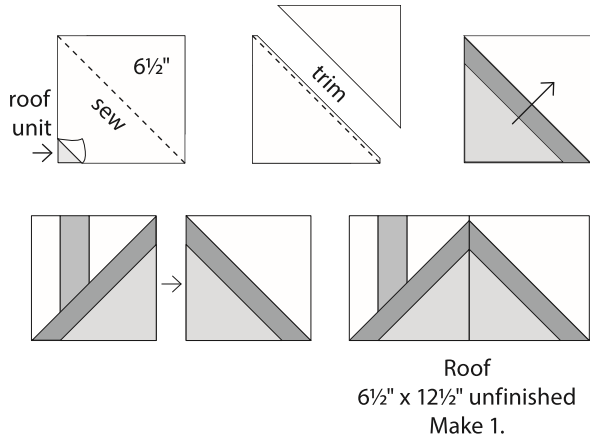

2 Heart

Draw a diagonal line from corner to corner on the wrong side of 2–3½" house squares, and 4–1½" house squares. Layer, sew, trim, and press as shown on 2–3½" x 5½" hearts. Join the 2 sides to make the heart.

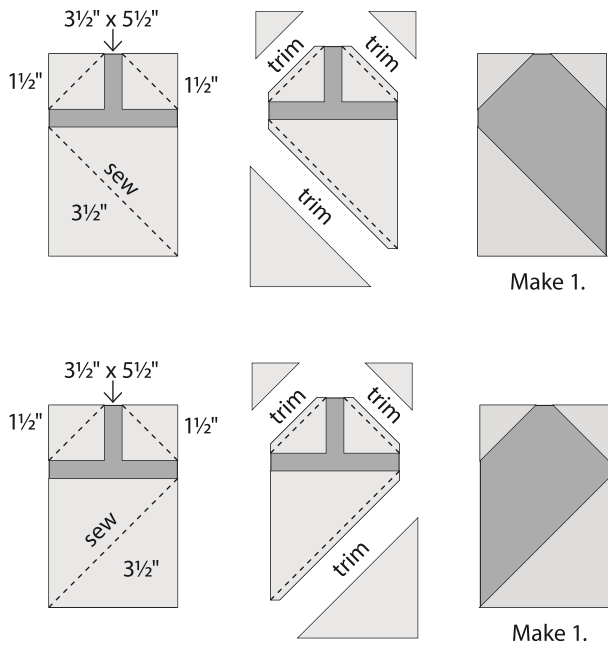

3 House assembly
Assemble the heart house as shown. Use fusible web and a zig zag or blanket stitch to add the bird to the completed house block.

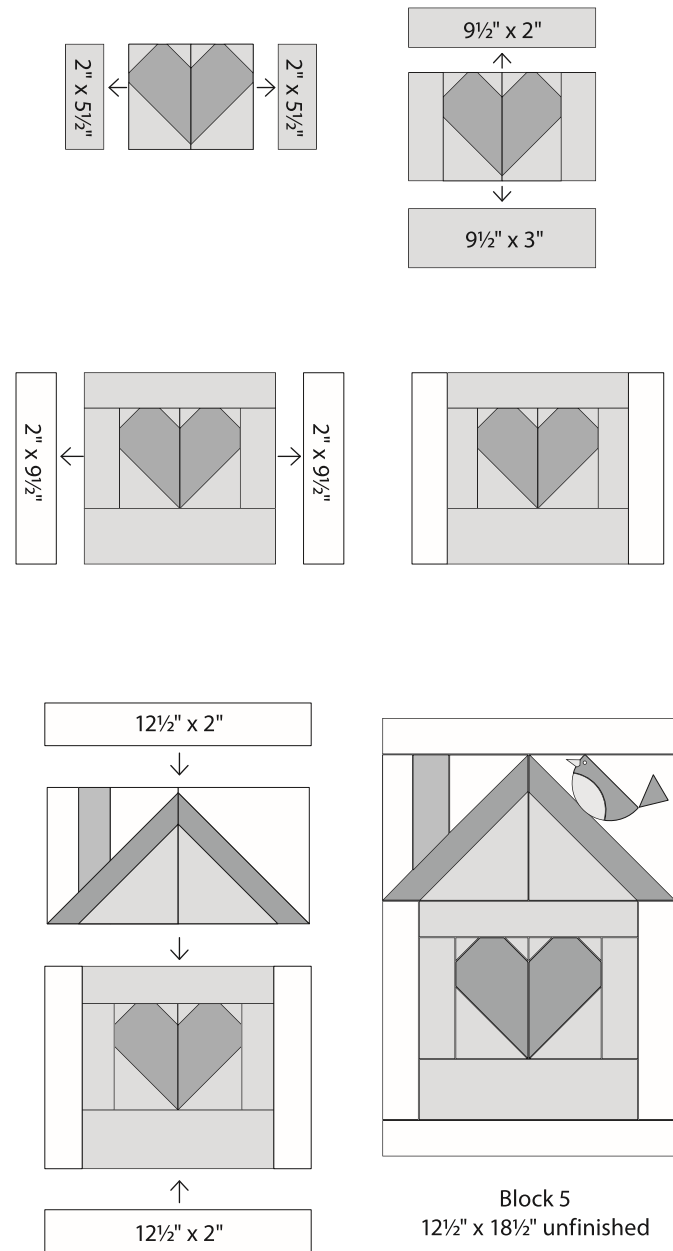

moda

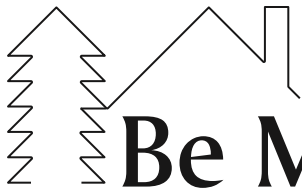

moda

Be My Neighbor

Block 6

18" x 18" finished

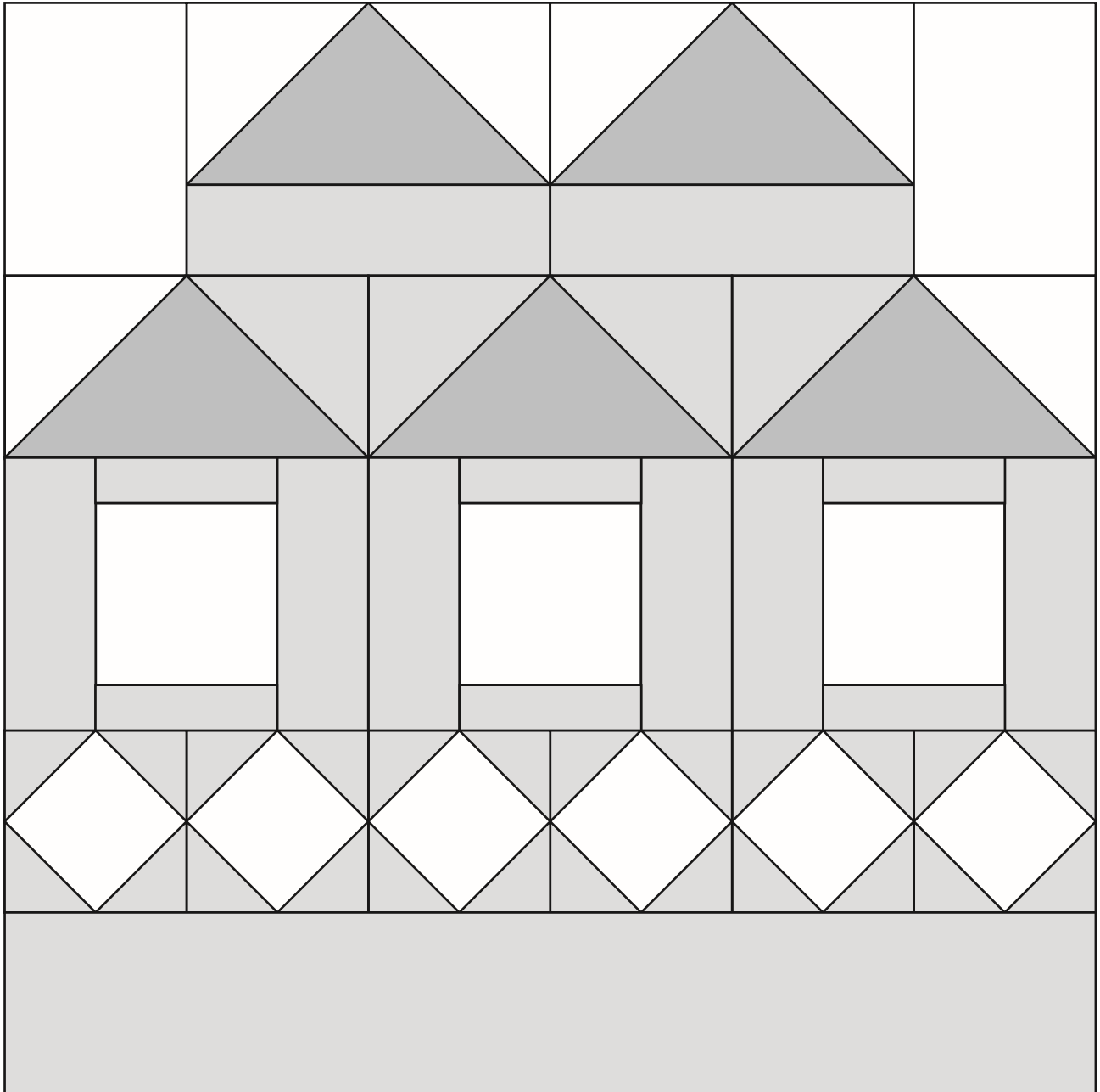

General Information

- These are very scrappy blocks. Mix your favorite Moda prints to create your colorful neighborhood!
- Share your progress and final quilt at #BeMyNeighbor. We love to see your results!!!

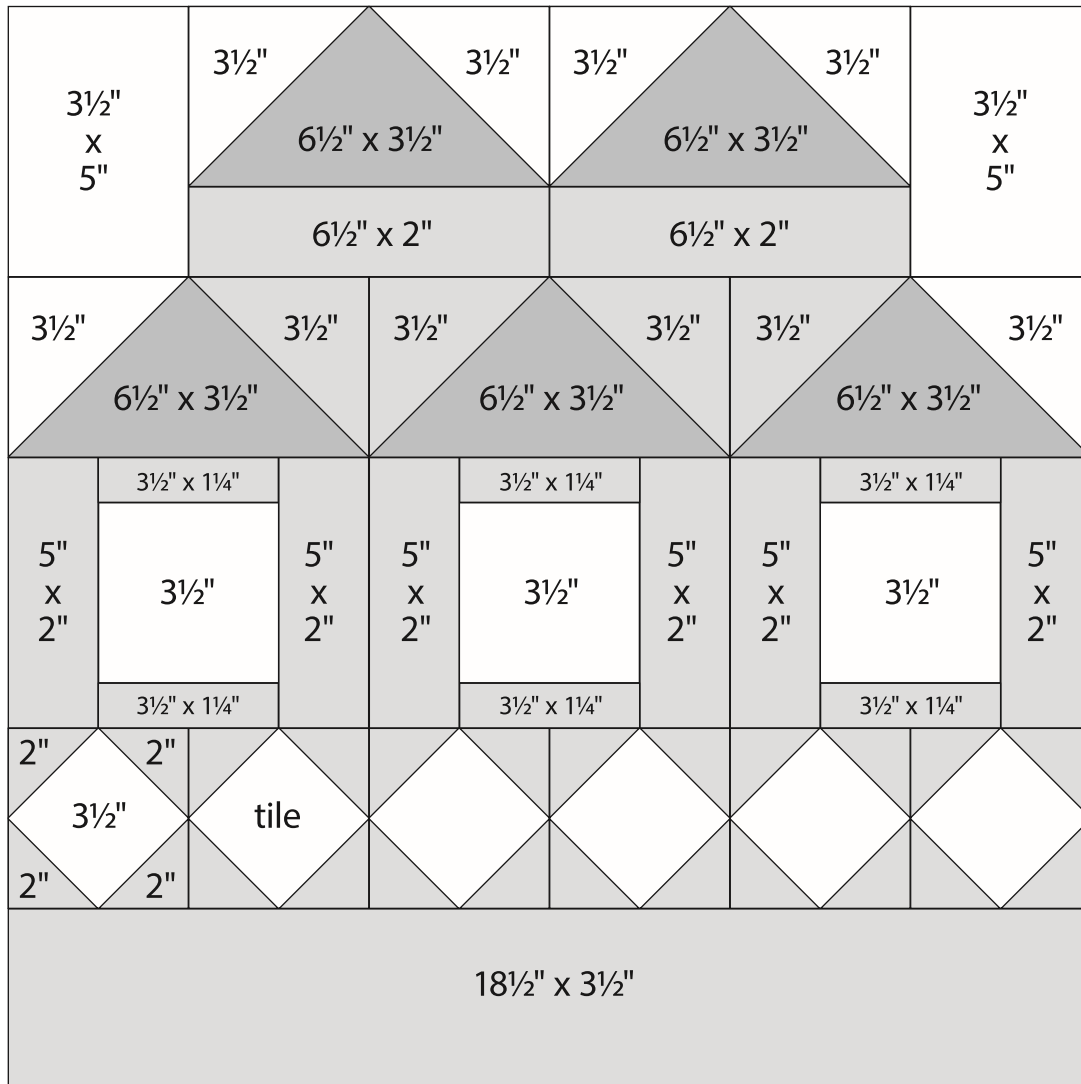

Block 6
18½" x 18½" unfinished

Cutting

House Rooftops

5–6½" x 3½" rectangles

Tiles

6–3½" squares

Windows

3–3½" squares

House

1–18½" x 3½" rectangle

2–6½" x 2" rectangles

6–5" x 2" rectangles

4–3½" squares

6–3½" x 1¼" rectangles

24–2" squares

Background

2–3½" x 5" rectangles

6–3½" squares

Be My Neighbor

Block 6 is 18" x 18" finished.

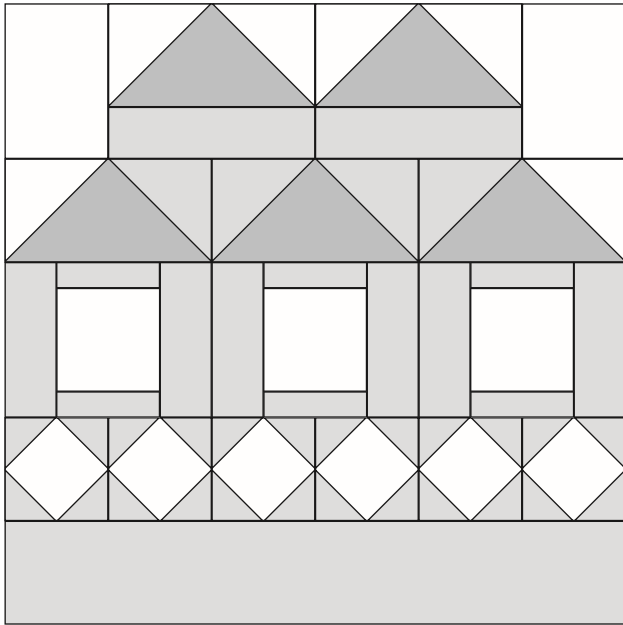

Construction

Use $\frac{1}{4}$ " seams. Press in the direction of the arrows in the diagrams.

1 House Rooftops A, B, C, and D

Draw a diagonal line from corner to corner on the wrong side of $4-3\frac{1}{2}$ " house squares and $6-3\frac{1}{2}$ " background squares.

The same technique is used to make all the roof tops. Just note whether you are using a marked house or marked background square. Layer a marked square, right sides to together, on $1-6\frac{1}{2}$ " x $3\frac{1}{2}$ " roof rectangle as shown. Sew on the diagonal line. Trim $\frac{1}{4}$ " from the sewn line. Press to reveal the triangle. Repeat on the opposite end of the same rectangle.

House Roof A

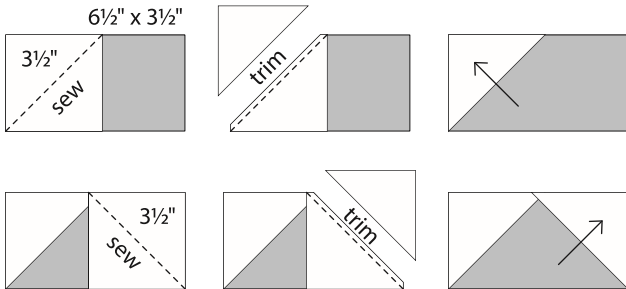

House Roof A
 $6\frac{1}{2}$ " x $3\frac{1}{2}$ " unfinished
Make 2.

house roof tops continued . . .

House Roof B

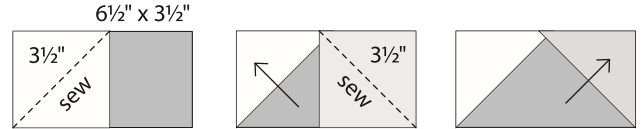

House Roof B
 $6\frac{1}{2}$ " x $3\frac{1}{2}$ " unfinished
Make 1.

House Roof C

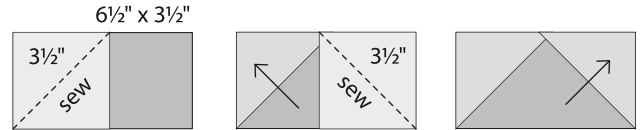

House Roof C
 $6\frac{1}{2}$ " x $3\frac{1}{2}$ " unfinished
Make 1.

House Roof D

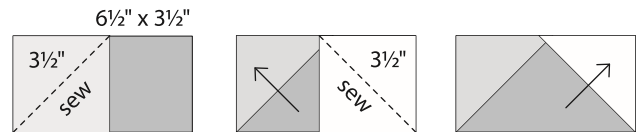

House Roof D
 $6\frac{1}{2}$ " x $3\frac{1}{2}$ " unfinished
Make 1.

2 Assemble windows and rooftops as shown.

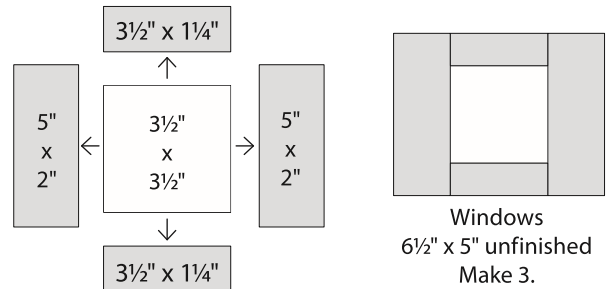

Windows
 $6\frac{1}{2}$ " x 5" unfinished
Make 3.

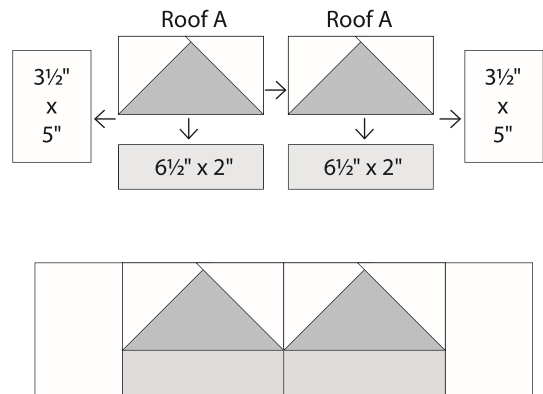

$18\frac{1}{2}$ " x 5" unfinished

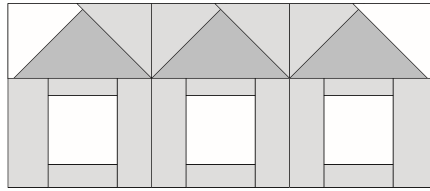
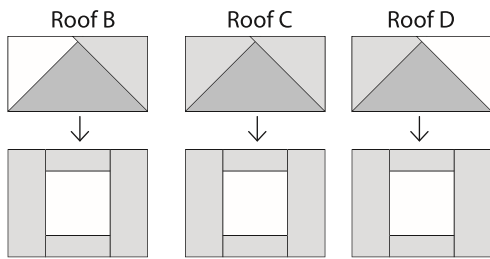

18½" x 8" unfinished

3 House Tiles

Draw a diagonal line from corner to corner on the wrong side of 24–2" house squares. Layer 2 marked squares on opposite corners of a 3" tile square, right sides to together. Sew on the diagonal lines. Trim ¼" from the sewn line. Press to reveal the triangles. Repeat on the opposite ends of the same square. Make 6.

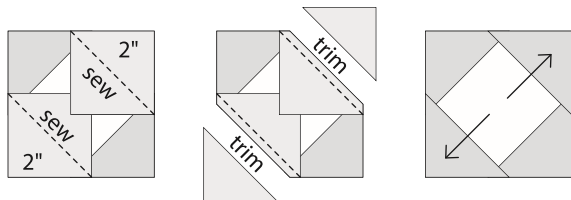
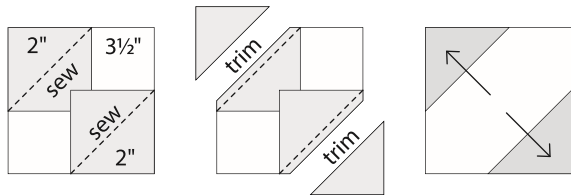

3½" x 3½" unfinished
Make 6.

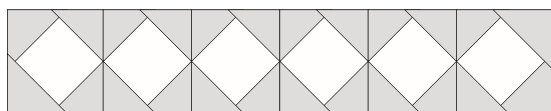
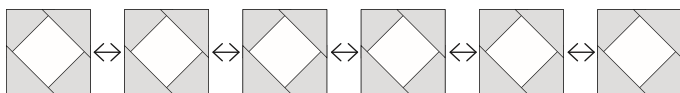

Tiles
18½" x 3½" unfinished
Make 1.

4 Assemble the block as shown.

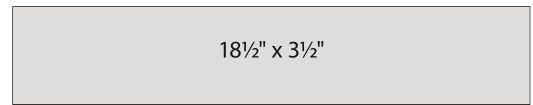
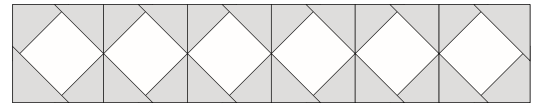
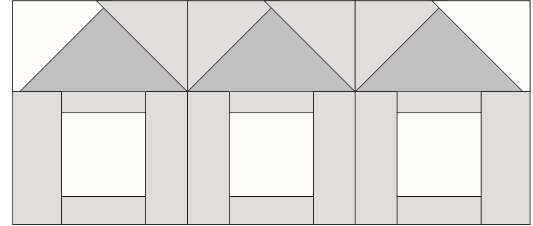
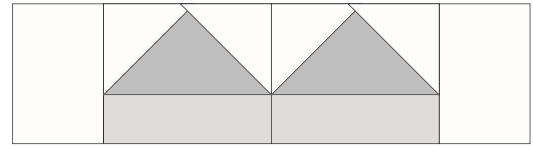

18½" x 3½"

moda

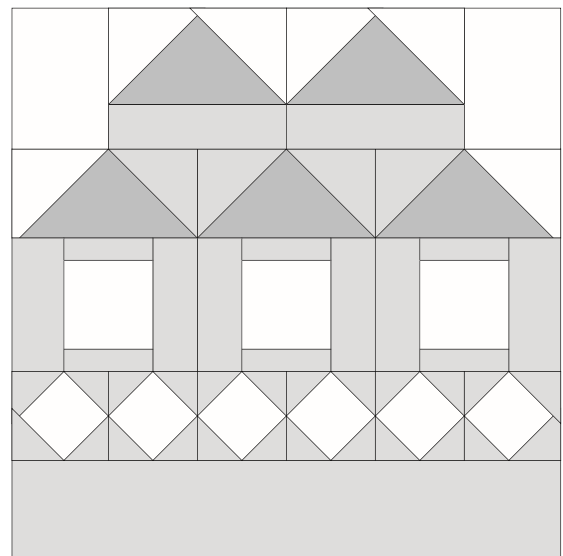

Block 6
18½" x 18½" unfinished

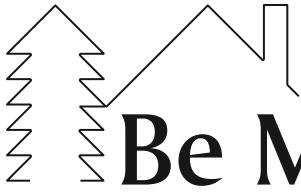

moda

Be My Neighbor

Block 7
15" x 18" finished

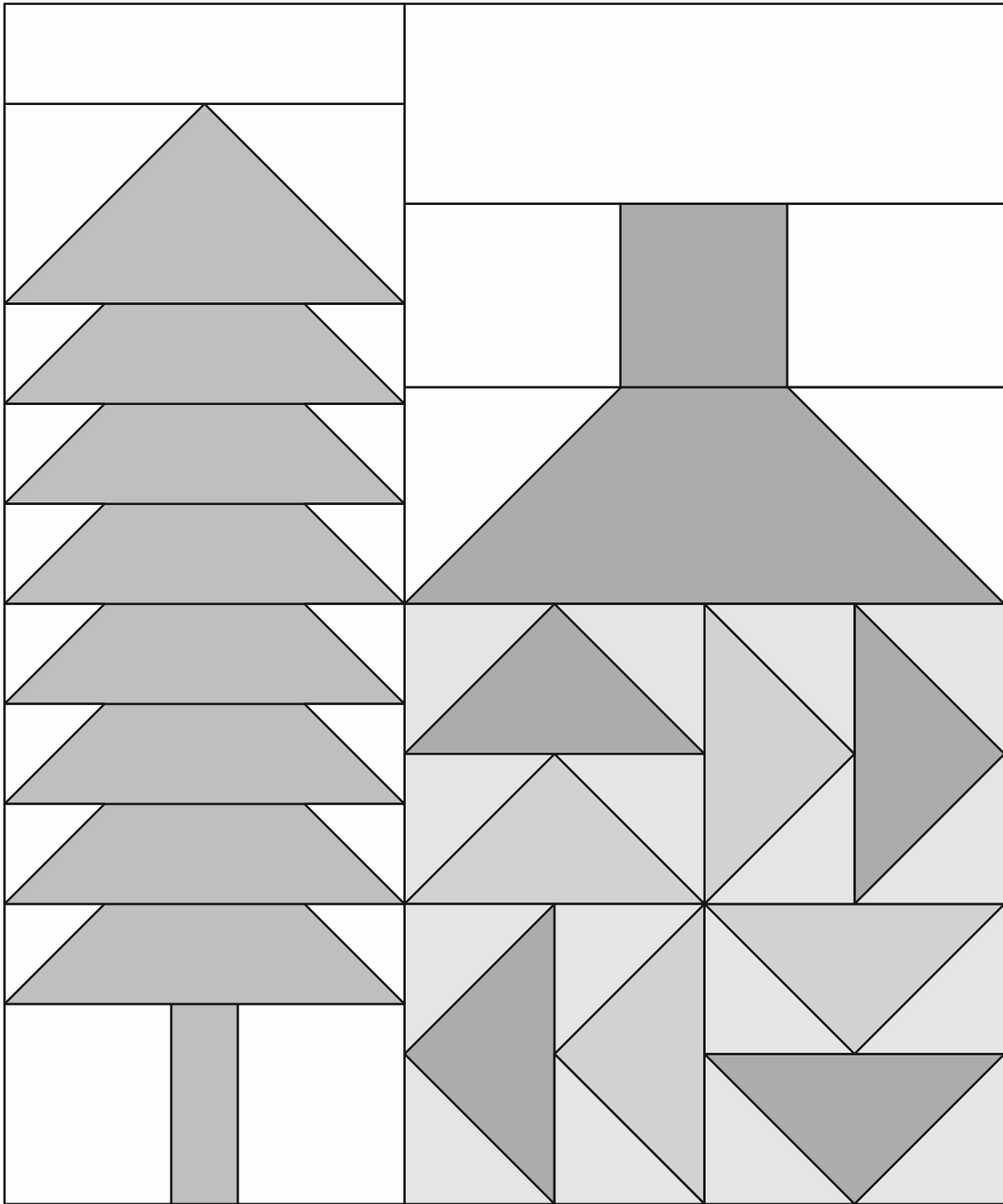

General Information

- These are very scrappy blocks. Mix your favorite Moda prints to create your colorful neighborhood!
- Share your progress and final quilt at #BeMyNeighbor. We love to see your results!!!

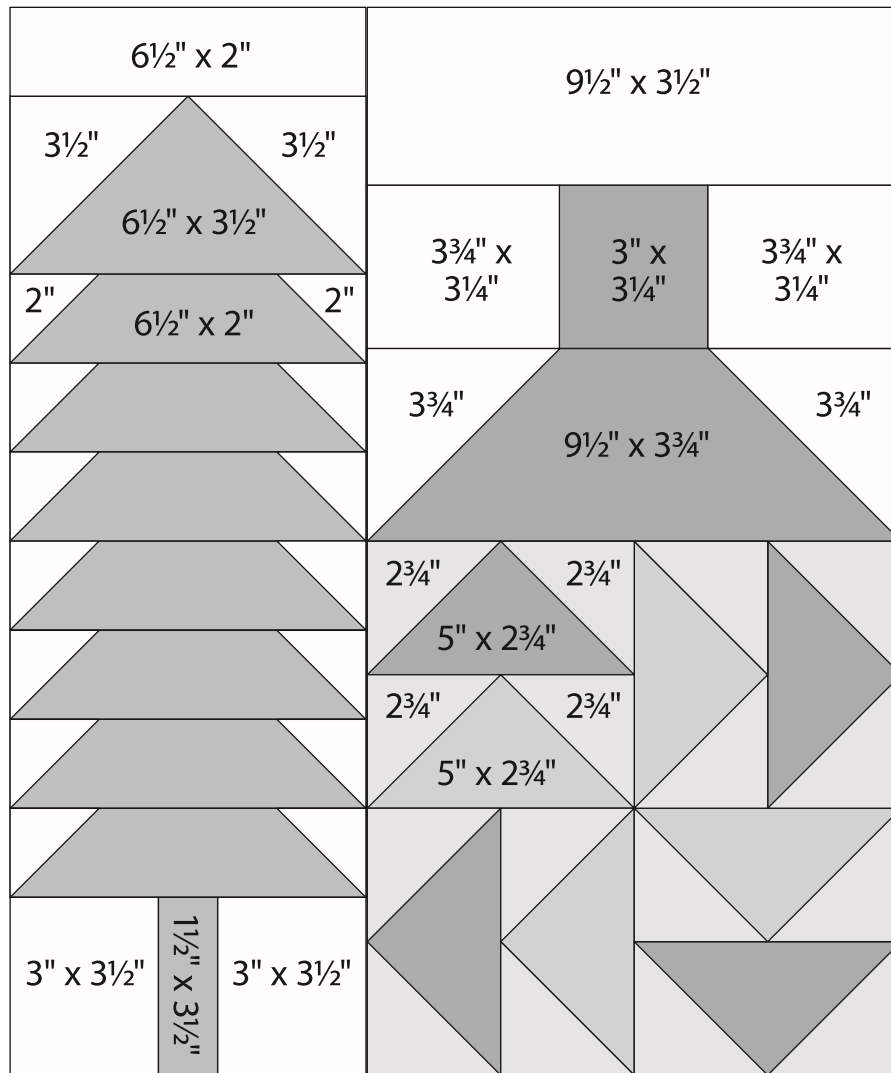

Block 7
15 1/2" x 18 1/2" unfinished

Cutting

Tree

1-6 1/2" x 3 1/2" rectangle
7-6 1/2" x 2" rectangles

Tree Trunk

1-1 1/2" x 3 1/2" rectangle

House Roof and Chimney

1-9 1/2" x 3 3/4" rectangle
1-3" x 3 1/4" rectangle

House

16-2 3/4" squares

Flying Geese Dark

4-5" x 2 3/4" rectangles

Flying Geese Medium

4-5" x 2 3/4" rectangles

Background

1-9 1/2" x 3 1/2" rectangle
1-6 1/2" x 2" rectangle
2-3 3/4" squares
2-3 3/4" x 3 1/4" rectangles
2-3 1/2" squares
2-3" x 3 1/2" rectangles
14-2" squares

Be My Neighbor

Block 7 is 15" x 18" finished.

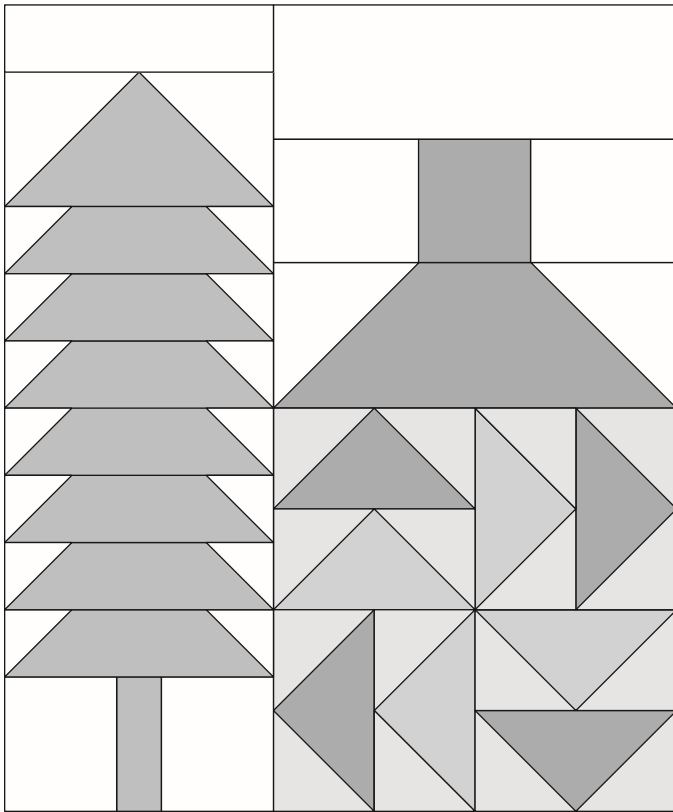

Construction

Use $\frac{1}{4}$ " seams. Press in the direction of the arrows in the diagrams.

1 House

(A) Draw a diagonal line from corner to corner on the wrong side of $2-3\frac{3}{4}$ " background squares. Layer a $3\frac{3}{4}$ " marked background square, right sides to together, on both ends of a $1-9\frac{1}{2}$ " x $3\frac{3}{4}$ " roof rectangle as shown. Sew on the diagonal lines. Trim $\frac{1}{4}$ " from the sewn lines. Press to reveal the triangles.

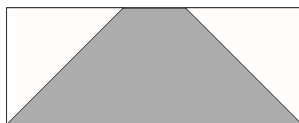
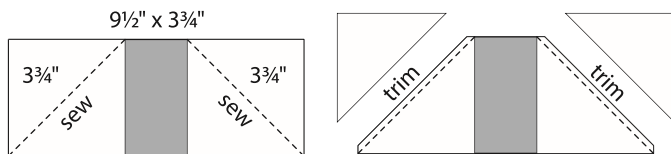

Roof
 $9\frac{1}{2}$ " x $3\frac{3}{4}$ " unfinished

House continued . . .

(B) Draw a diagonal line from corner to corner on the wrong side of $16-2\frac{3}{4}$ " house squares. Layer a $2\frac{3}{4}$ " marked house square, right sides to together, on $1-5$ " x $2\frac{3}{4}$ " flying geese rectangle as shown. Sew on the diagonal line. Trim $\frac{1}{4}$ " from the sewn line. Press to reveal the triangle. Repeat on the opposite end of the same rectangle. Make 4 dark and 4 medium.

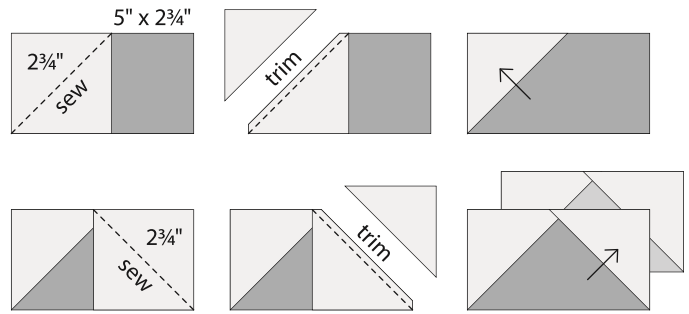

Flying Geese
 5 " x $2\frac{3}{4}$ " unfinished
Make 4 dark and 4 medium.

(C) Join 1 dark and medium flying geese as shown. Make 4.

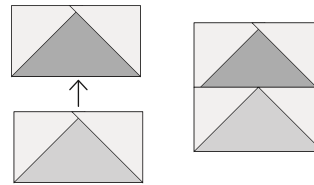

5 " x 5 " unfinished
Make 4.

(D) Assemble the house bottom.

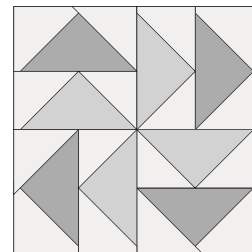
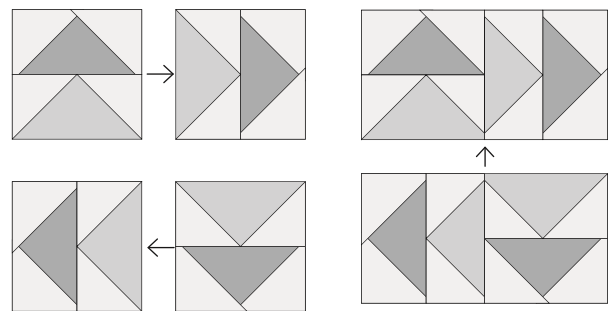

House Bottom
 $9\frac{1}{2}$ " x $9\frac{1}{2}$ " unfinished

House continued . . .

(E) Assemble the house as shown.

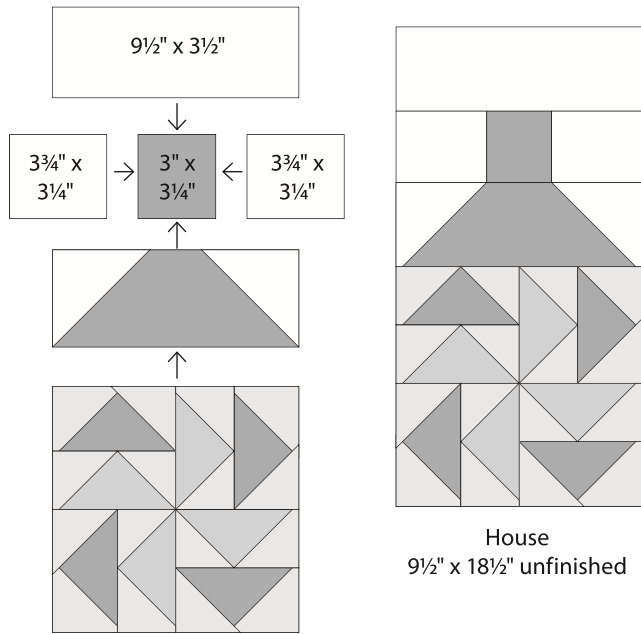

(C) Assemble the tree as shown.

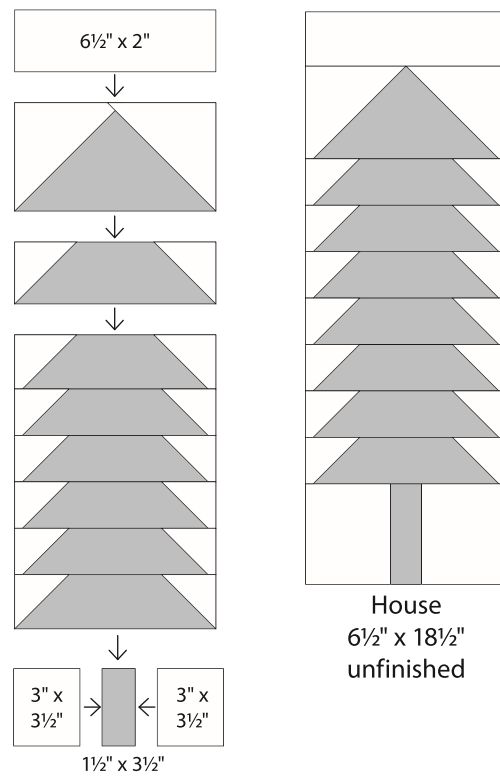

2 Tree

(A) Draw a diagonal line from corner to corner on the wrong side of 2–3 1/2" background squares. Layer a 3 1/2" marked background square, right sides to together, on 1–6 1/2" x 3 1/2" tree rectangle as shown. Sew on the diagonal line. Trim 1/4" from the sewn line. Press to reveal the triangle. Repeat on the opposite end of the same rectangle. Make 1.

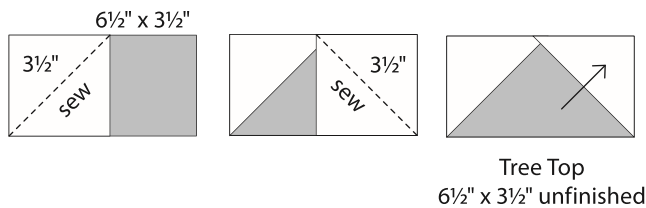

(B) Draw a diagonal line from corner to corner on the wrong side of 14–2" background squares. Layer 2" marked background square, right sides to together, on 1–6 1/2" x 2" tree rectangle as shown. Sew on the diagonal line. Trim 1/4" from the sewn line. Press to reveal the triangle. Repeat on the opposite end of the same rectangle. Make 7.

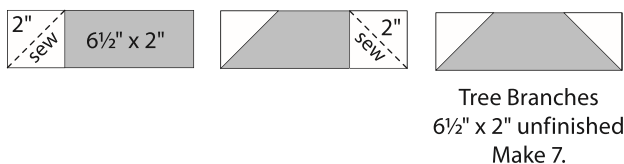

3 Assemble the block as shown.

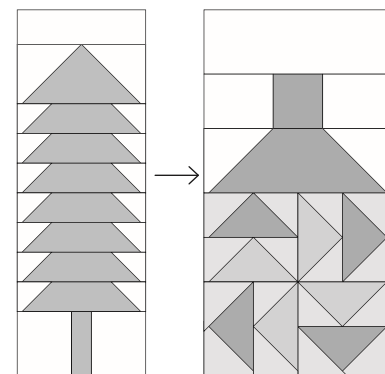

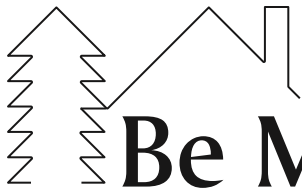

moda

Be My Neighbor

Block 8

15" x 18" finished

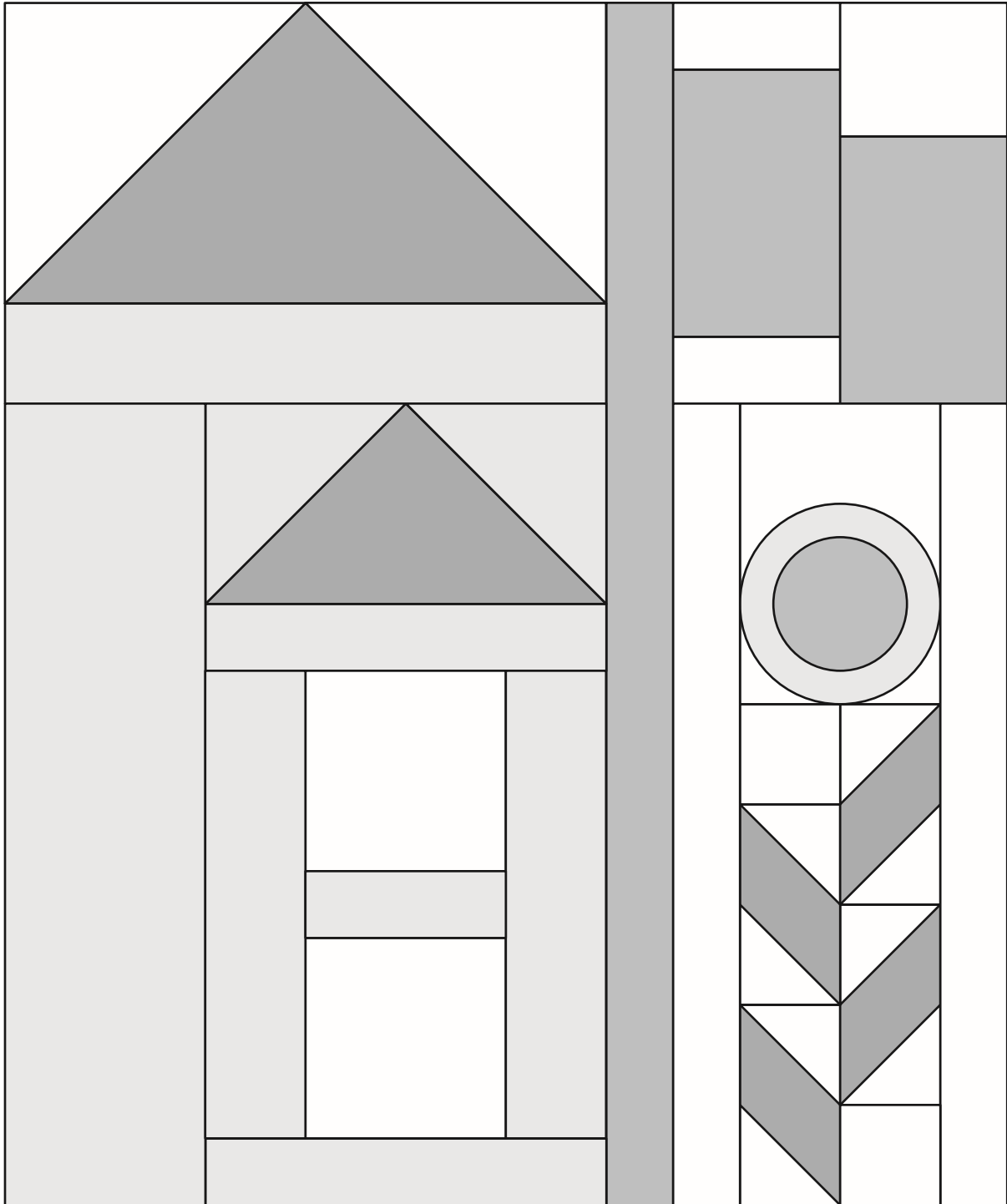

General Information

- These are very scrappy blocks. Mix your favorite Moda prints to create your colorful neighborhood!
- Share your progress and final quilt at #BeMyNeighbor. We love to see your results!!!

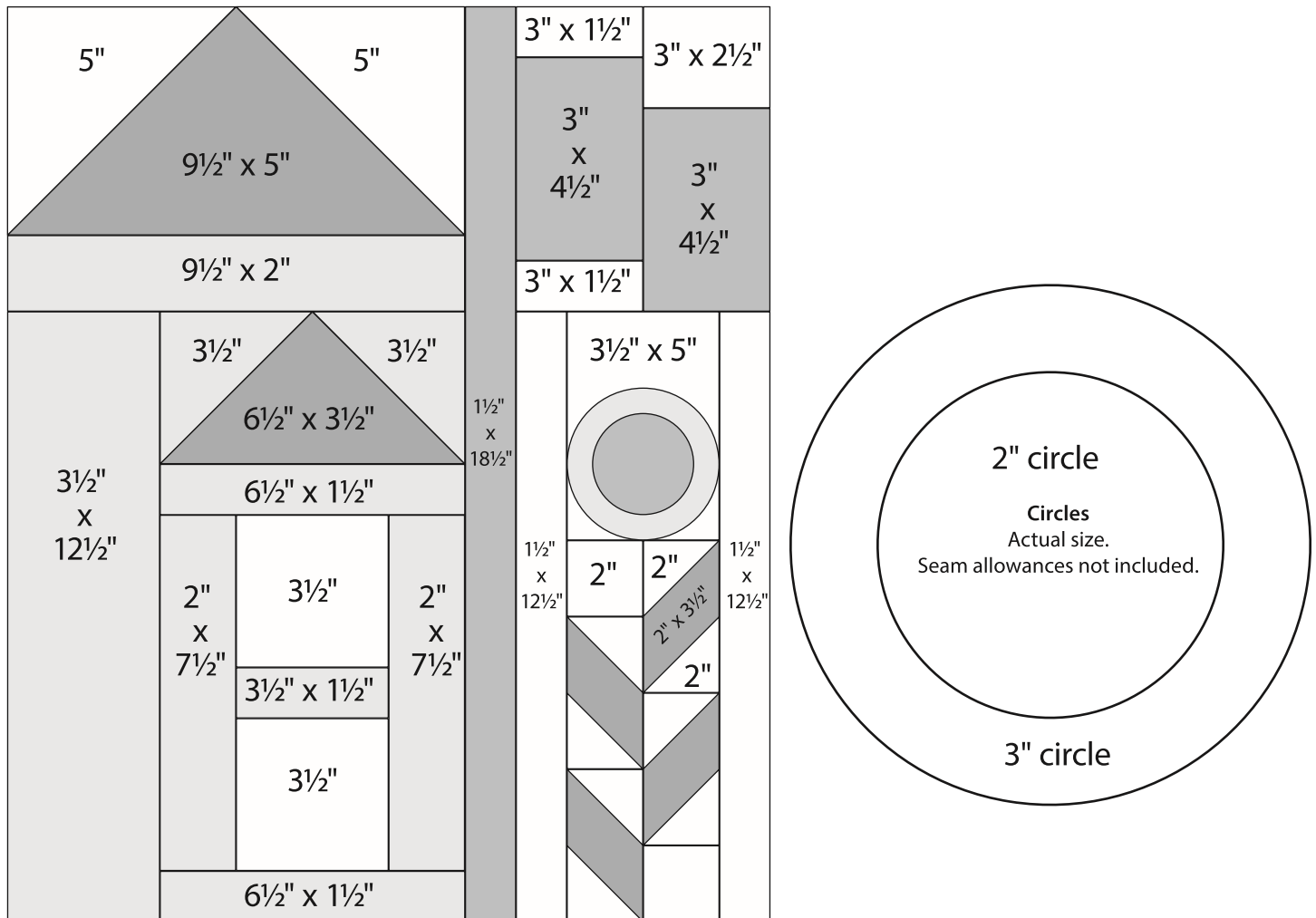

Block 8
15½" x 18½" unfinished

Cutting

Leaves

4–2" x 3½" rectangles

Flowers

2 circles

Roof

1–9½" x 5" rectangle

1–6½" x 3½" rectangle

Flag

2–3" x 4½" rectangles

Flag Pole

1–1½" x 18½" rectangle

Window

2–3½" squares

House

1–9½" x 2" rectangle

2–6½" x 1½" rectangles

1–3½" x 12½" rectangle

1–3½" x 1½" rectangle

2–3½" squares

2–2" x 7½" rectangles

Background

2–5" squares

1–3½" x 5" rectangle

2–3" x 1½" rectangles

1–3" x 2½" rectangle

10–2" squares

2–1½" x 12½" rectangles



moda Be My Neighbor

Block 8 is 15" x 18" finished.

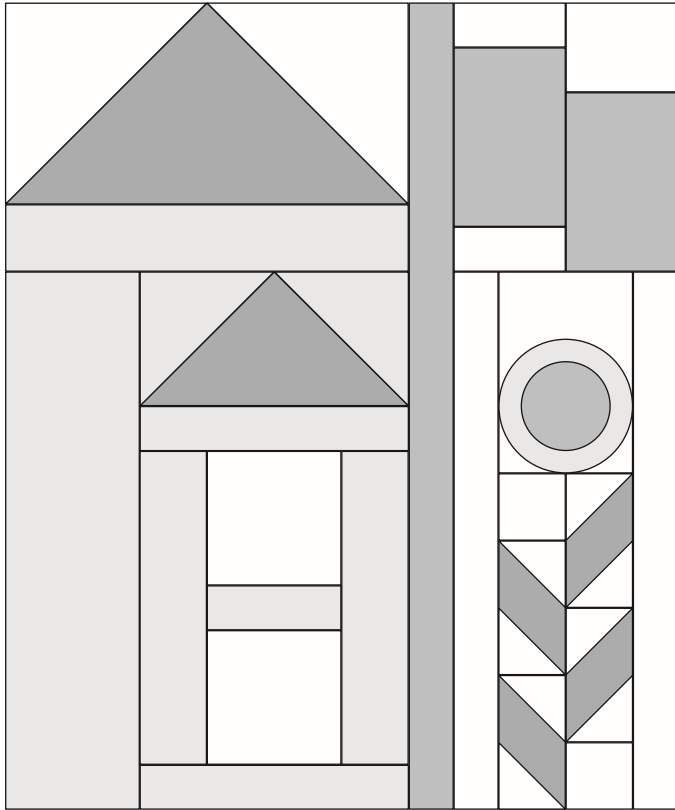

- 2 House Roof Small**
 Draw a diagonal line from corner to corner on the wrong side of 2-3½" house squares. Layer a 3½" marked house square, right sides to together, on 1-6½" x 3½" small roof rectangle as shown. Sew, trim, and press. Repeat on the the opposite end of the same rectangle. Make 1.

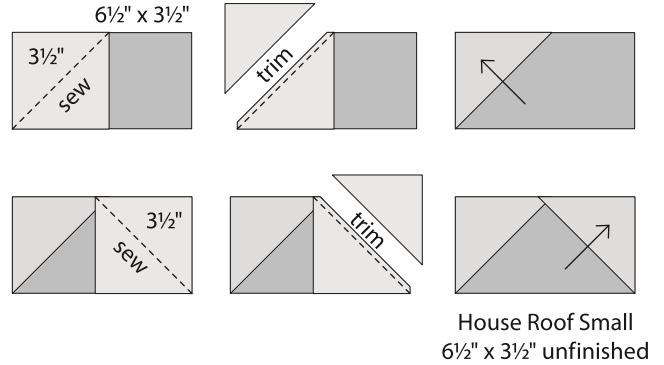

- 3** Assemble the house as shown.

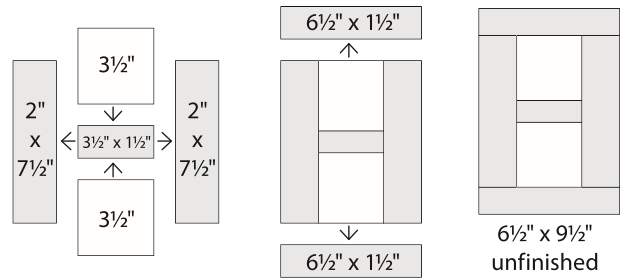

Construction

Use ¼" seams. Press in the direction of the arrows in the diagrams.

- 1 House Roof Large**
 Draw a diagonal line from corner to corner on the wrong side of 2-5" background squares. Layer a 5" marked background square, right sides to together, on 1-9½" x 5" roof rectangle as shown. Sew on the diagonal line. Trim ¼" from the sewn line. Press to reveal the triangle. Repeat on the the opposite end of the same rectangle. Make 1.

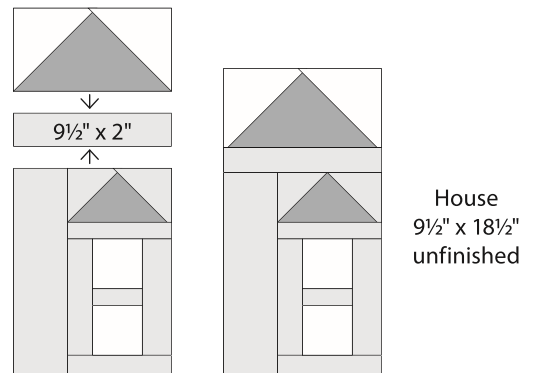
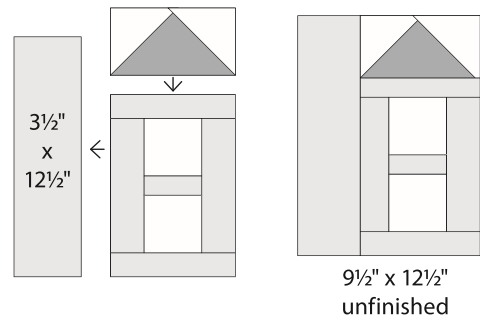
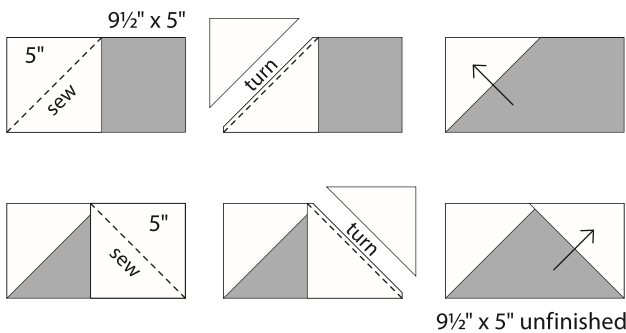

4 Flower

(A) Draw a diagonal line from corner to corner on the wrong side of 8-2" background squares. Layer a 2" marked background square, right sides to together, on 1-2" x 3 1/2" leaf rectangle as shown. Sew on the diagonal line. Trim 1/4" from the sewn line. Press to reveal the triangle. Repeat on the the opposite end of the same rectangle. Make 2 leaf As and 2 leaf Bs. *Note the 2" square placement is different.*

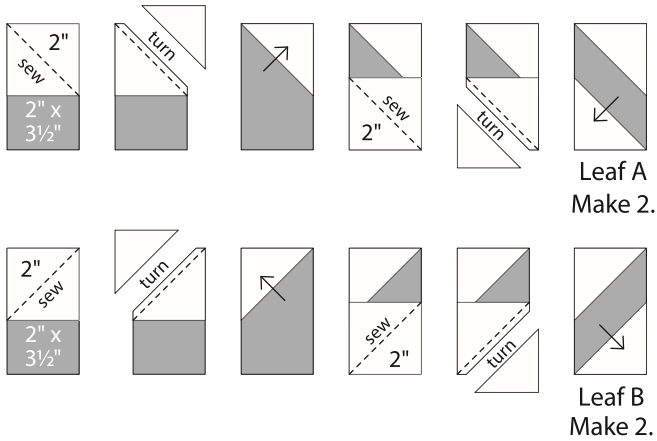

(B) Arrange and sew 2-Leaf As and 1-2" background square to make column A. Arrange sew 1-2" background square and sew 2-Leaf Bs to make column B. Join the columns, add a 3 1/2" x 5" background rectangle. Add 2-1 1/2" x 12 1/2" background rectangles. Use you appliqué method of choice to add the circles.

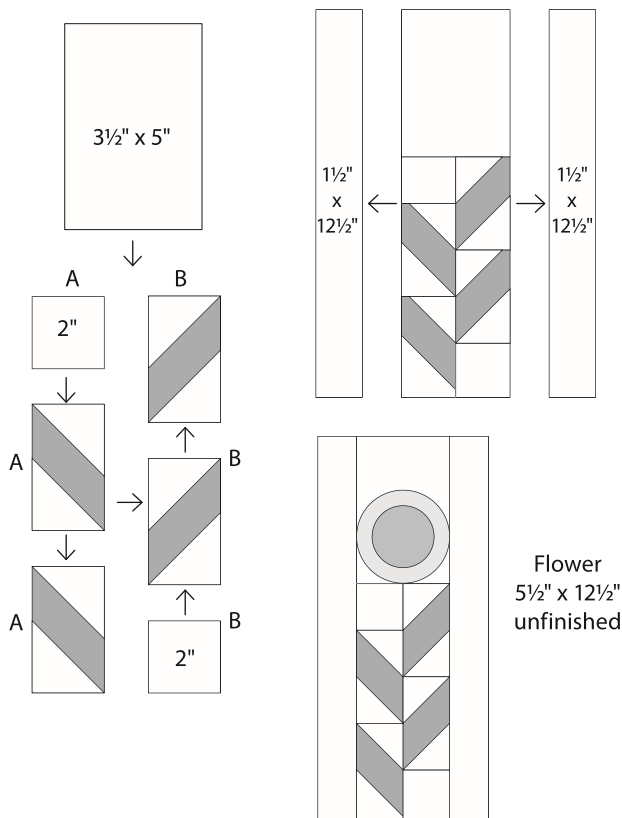

5 Assemble the flag as shown.

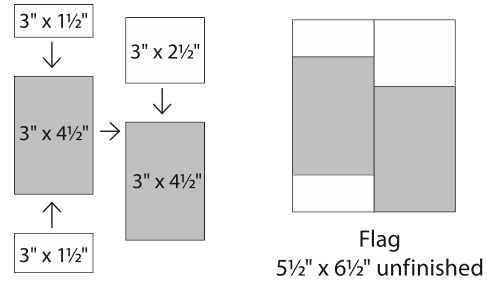

moda

6 Assemble the block as shown.

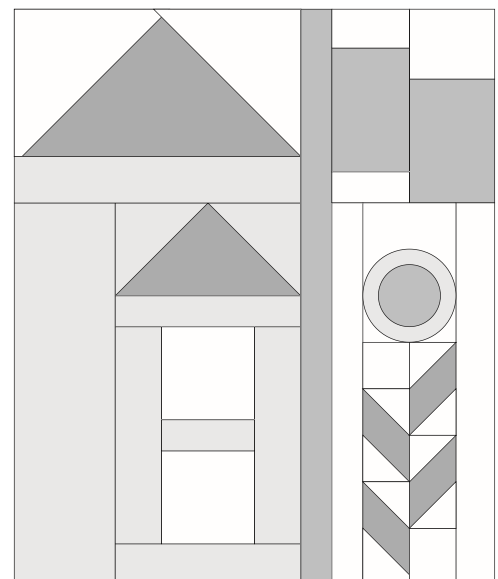
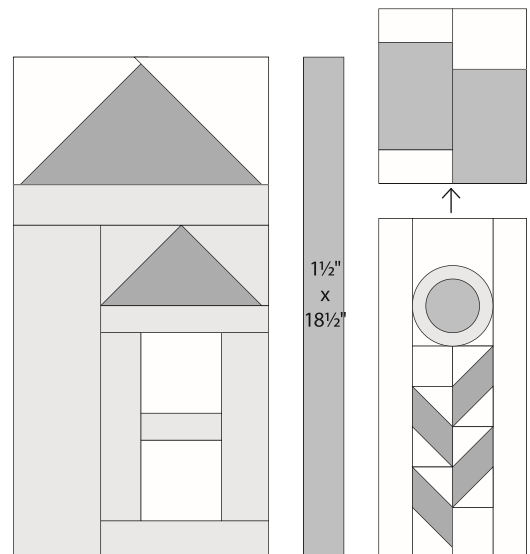

Block 8
15 1/2" x 18 1/2" unfinished

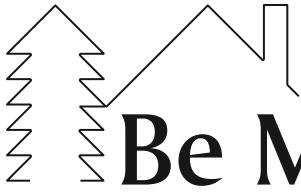

moda

Be My Neighbor

Block 9
15" x 18" finished

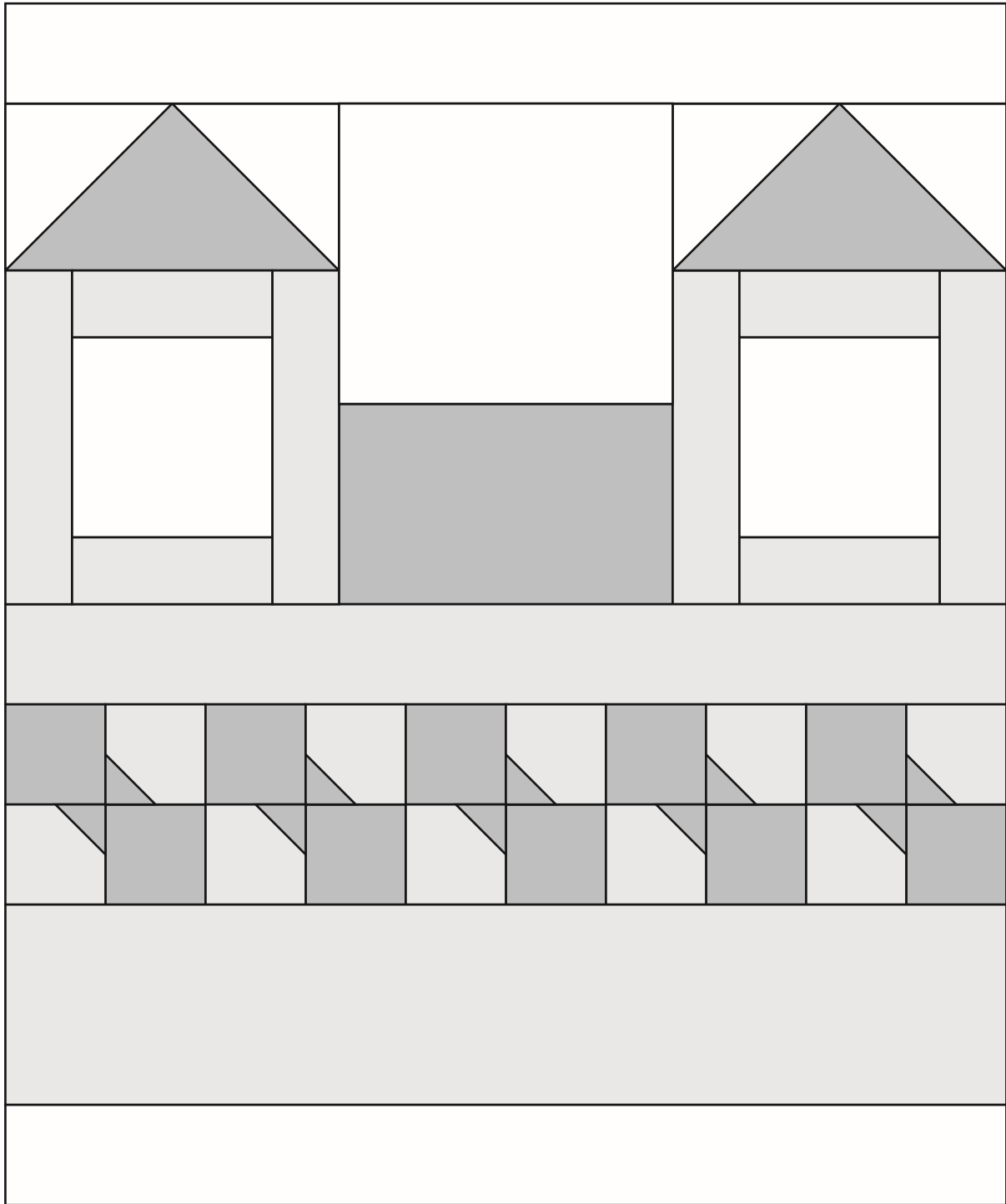

General Information

- These are very scrappy blocks. Mix your favorite Moda prints to create your colorful neighborhood!
- Share your progress and final quilt at #BeMyNeighbor. We love to see your results!!!

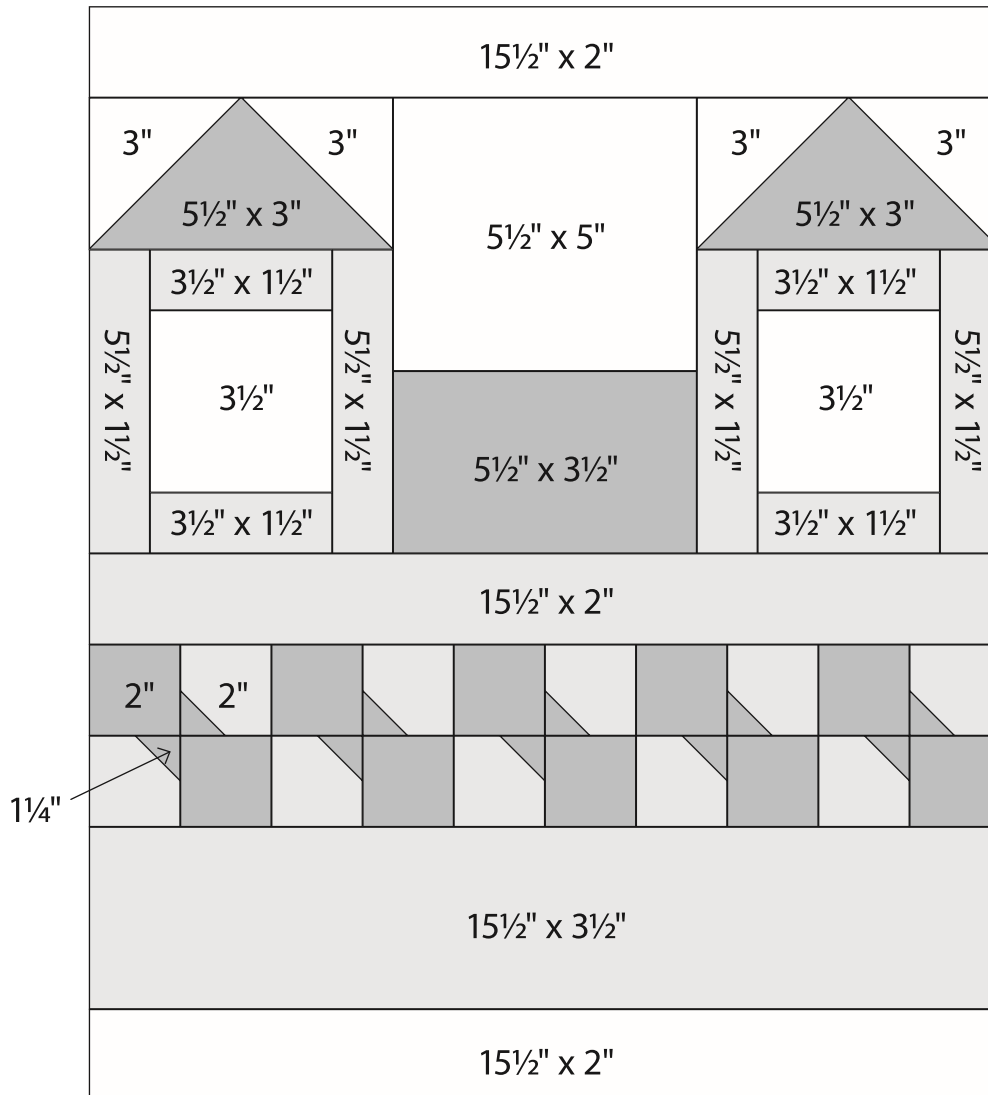

Block 9
15½" x 18½" unfinished

Cutting

House Roof

- 1–5½" x 3½" rectangle
- 2–5½" x 3" rectangles

Bowties (5 total)

- For EACH bowtie cut
- 2–2" squares and 2–1¼" squares

Windows

- 2–3½" squares

House

- 1–15½" x 3½" rectangle
- 1–15½" x 2" rectangle
- 10–2" squares
- 4–5½" x 1½" rectangles
- 4–3½" x 1½" rectangles

Background

- 2–15½" x 2" rectangles
- 1–5½" x 5" rectangles
- 4–3" squares

Be My Neighbor

Block 9 is 15" x 18" finished.

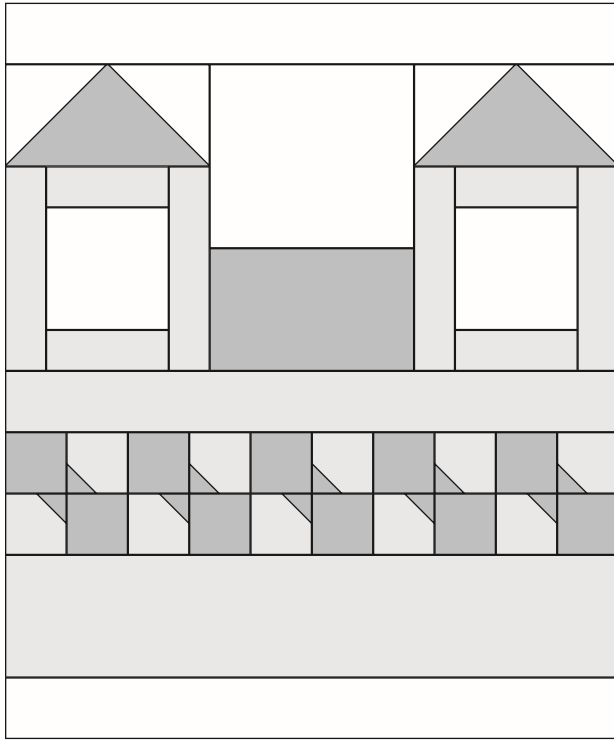

House Rooftops and Windows continued . . .

(B) Assemble windows and rooftops as shown.

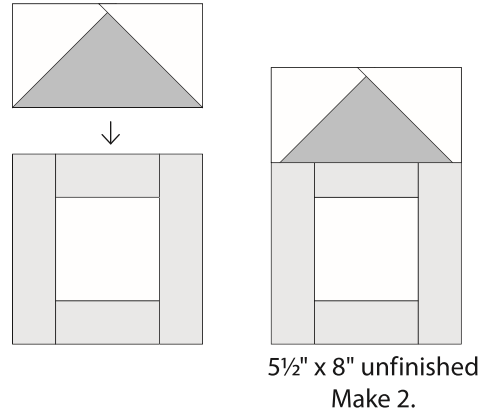
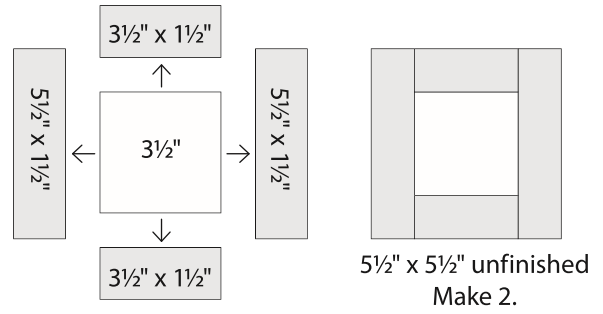

Construction

Use 1/4" seams. Press in the direction of the arrows in the diagrams.

1 House Rooftops and Windows

(A) Draw a diagonal line from corner to corner on the wrong side of 4-3" background squares. Layer a 3" marked background square, right sides to together, on 1-5 1/2" x 3" roof rectangle as shown. Sew on the diagonal line. Trim 1/4" from the sewn line. Press to reveal the triangle. Repeat on the opposite end of the same rectangle. Make 2.

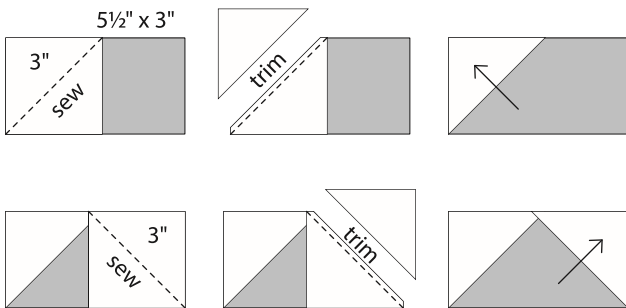

House
5 1/2" x 3" unfinished
Make 2.

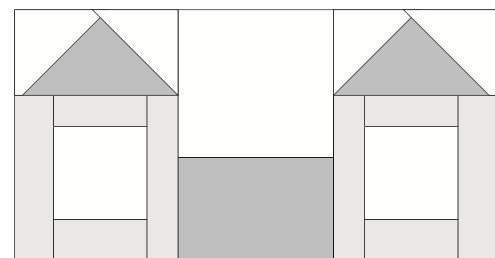
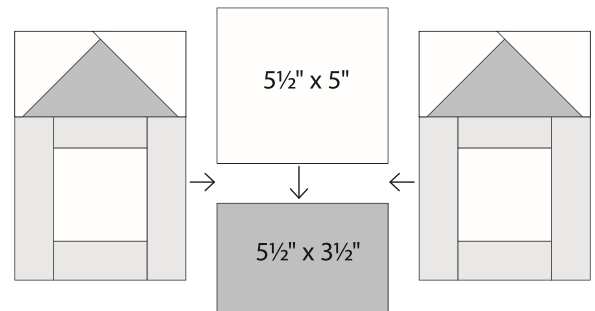

15 1/2" x 8" unfinished

2 To make one Bowtie

(A) Draw a diagonal line from corner to corner on the wrong side of 2-1 1/4" bowtie squares. Layer a 1 1/4" marked bowtie square, right sides together, on 1-2" house square as shown. Sew on the diagonal line. Trim 1/4" from the sewn line. Press to reveal the triangle.

Make 2.

Arrange and sew 2 rows of 1-2" bowtie square and 1 bowtie as shown. Join the rows. Repeat to make bowties.

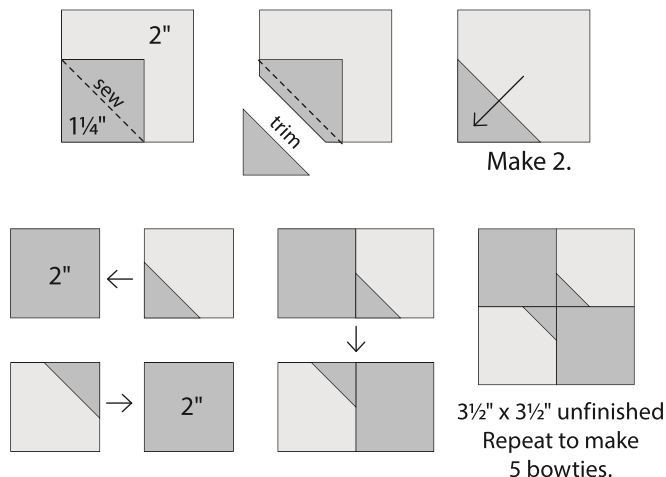

(B) Join the 5 bowties in one row.

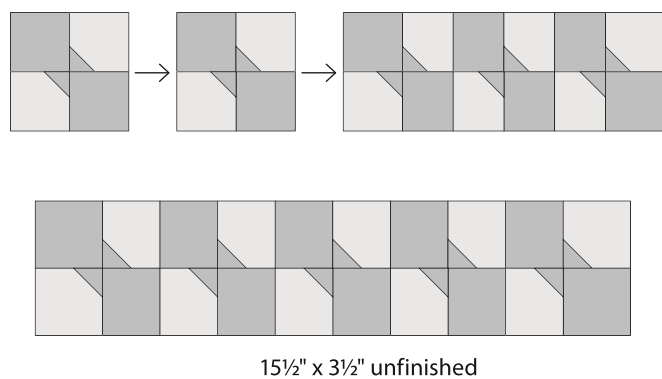

moda

3 Assemble the block as shown.

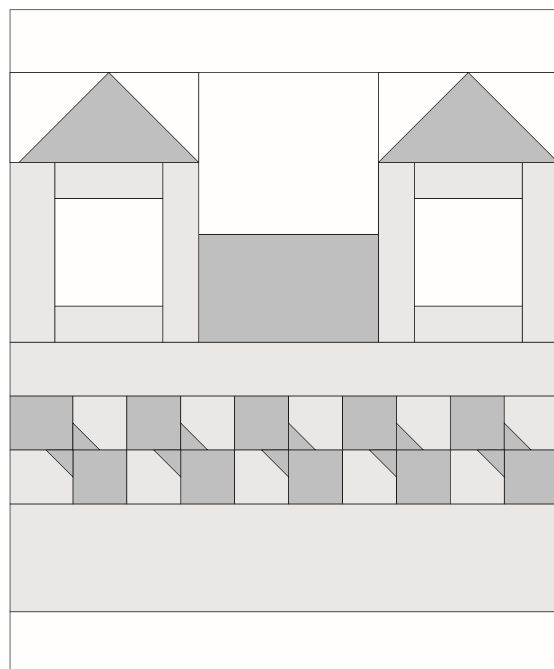
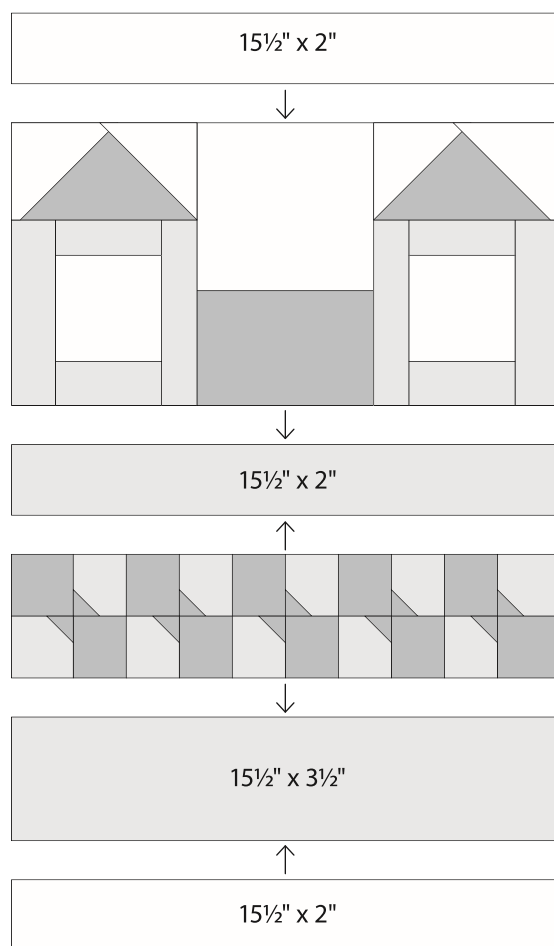

Block 9
 15 1/2" x 18 1/2" unfinished

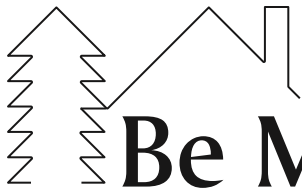

moda

Be My Neighbor

Block 10

15" x 18" finished

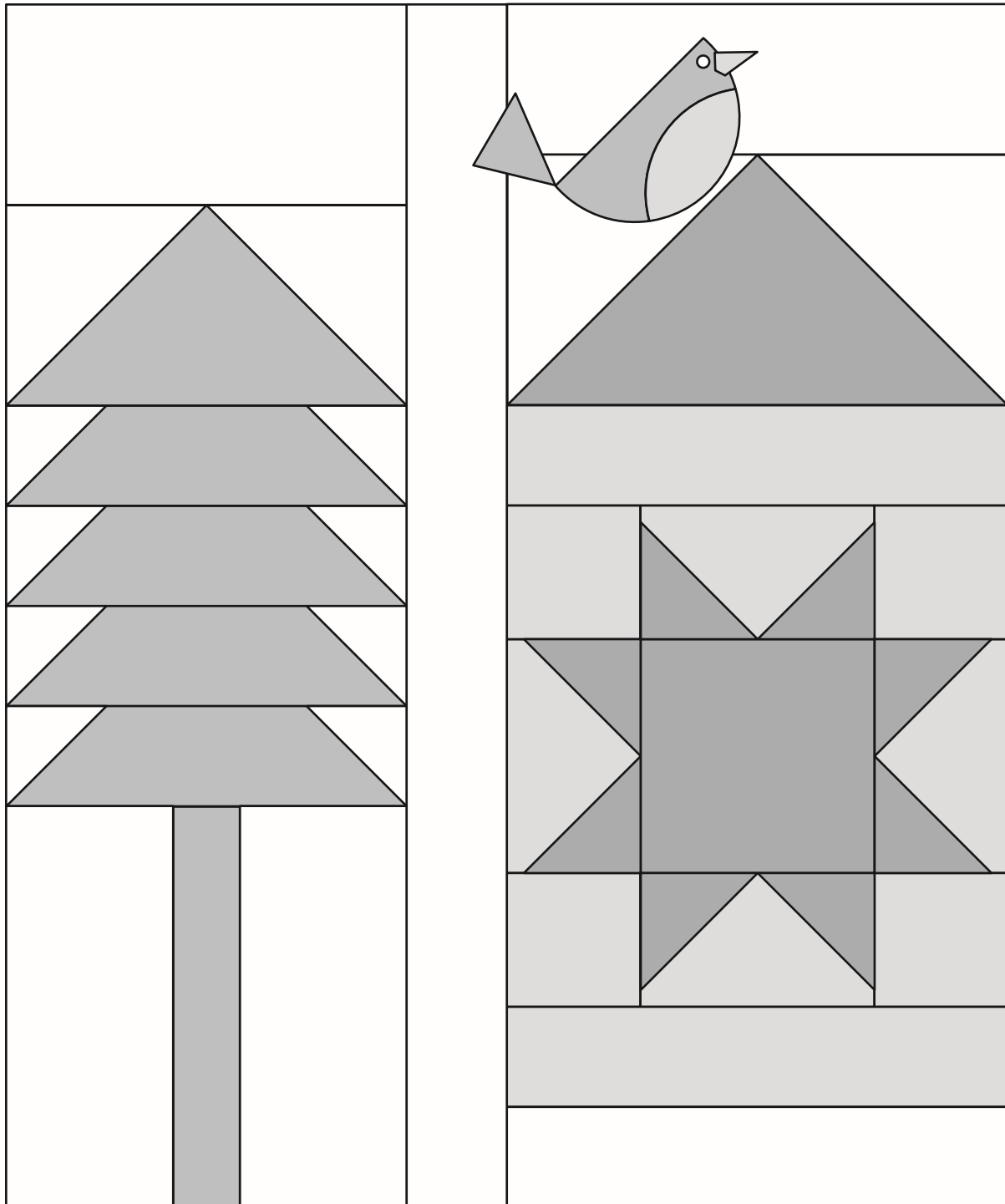

General Information

- These are very scrappy blocks. Mix your favorite Moda prints to create your colorful neighborhood!
- Share your progress and final quilt at #BeMyNeighbor. We love to see your results!!!

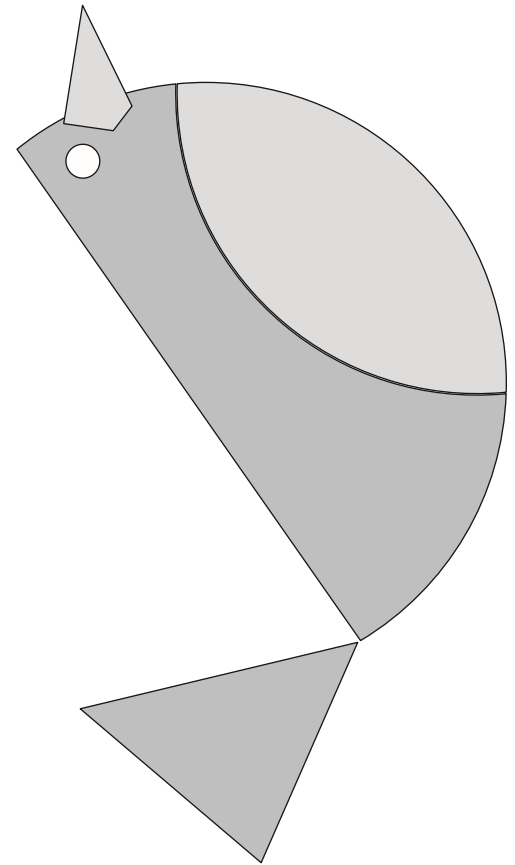
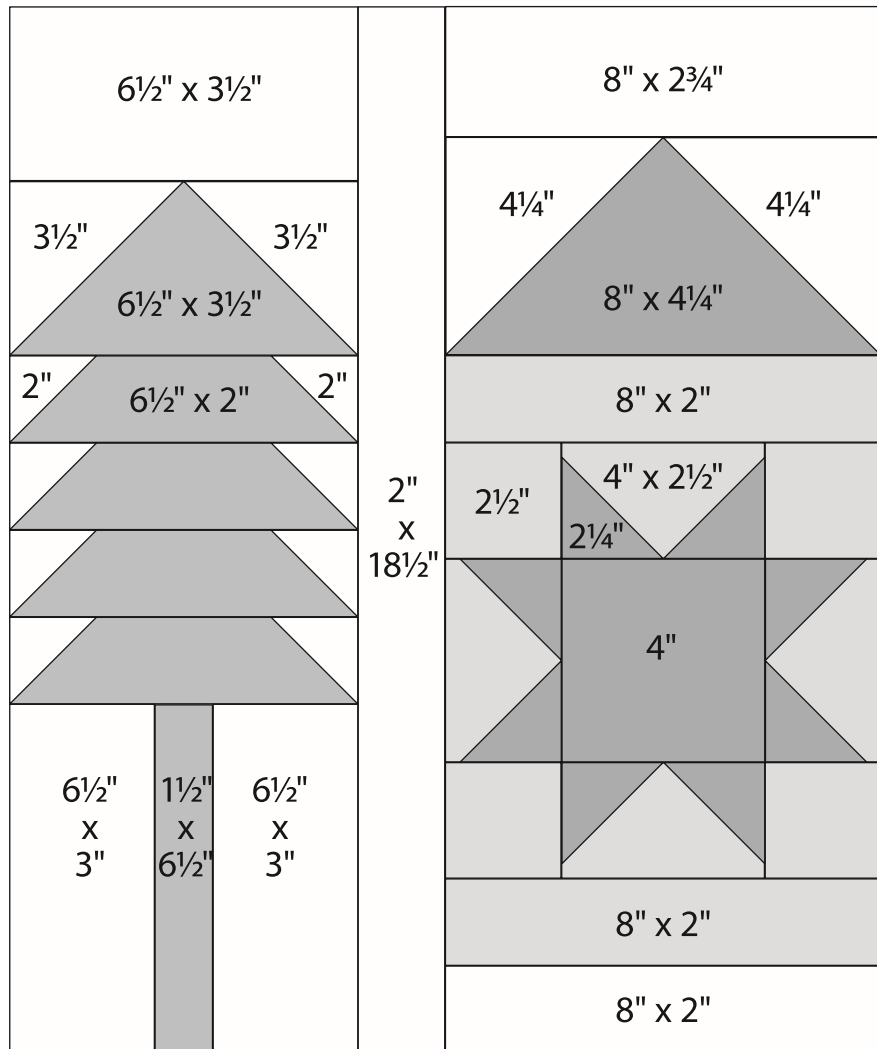

Bird Appliqué
Actual size.
Seam allowances not included.
Not reversed.

Block 10
15 1/2" x 18 1/2" unfinished

Cutting

Tree

1-6 1/2" x 3 1/2" rectangle
4-6 1/2" x 2" rectangles

Tree Trunk

1-1 1/2" x 6 1/2" rectangle

Star

1-4" square
8-2 1/4" squares

House Roof

1-8" x 4 1/4" rectangle

House

2-8" x 2" rectangles
4-4" x 2 1/2" rectangles
4-2 1/2" squares

Bird Appliqué

1-beak
1-body
1-tail
1-wing
1-eye

Background

1-8" x 2 3/4" rectangle
1-8" x 2" rectangle
1-6 1/2" x 3 1/2" rectangle
2-4 1/4" squares
2-3 1/2" squares
2-3" x 6 1/2" rectangles
1-2" x 18 1/2" rectangle
8-2 squares



Be My Neighbor

Block 10 is 15" x 18" finished.

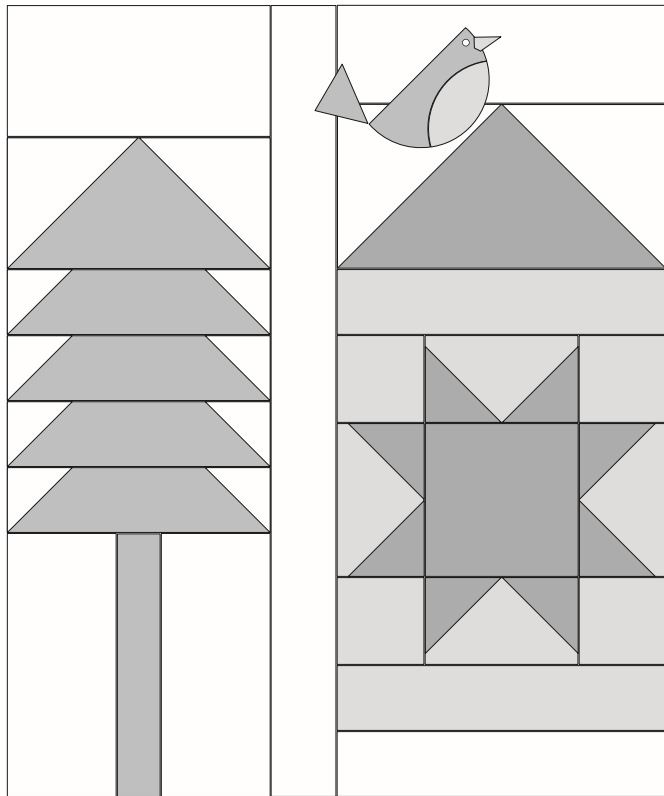

Construction

Use $\frac{1}{4}$ " seams. Press in the direction of the arrows in the diagrams.

1 Tree

(A) Draw a diagonal line from corner to corner on the wrong side of $2-3\frac{1}{2}$ " background squares. Layer a $3\frac{1}{2}$ " marked background square, right sides to together, on $1-6\frac{1}{2}$ " x $3\frac{1}{2}$ " tree rectangle as shown. Sew on the diagonal line. Trim $\frac{1}{4}$ " from the sewn line. Press to reveal the triangle. Repeat on the opposite end of the same rectangle. Make 1.

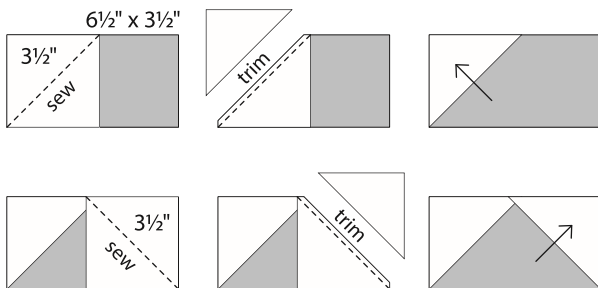

Tree Top
 $6\frac{1}{2}$ " x $3\frac{1}{2}$ " unfinished

tree continued . . .

(B) Draw a diagonal line from corner to corner on the wrong side of $8-2$ " background squares. Layer a 2 " marked background square, right sides to together, on both ends of a $1-6\frac{1}{2}$ " x 2 " tree rectangle as shown. Sew on the diagonal lines. Trim $\frac{1}{4}$ " from the sewn lines. Press to reveal the triangles. Make 4.

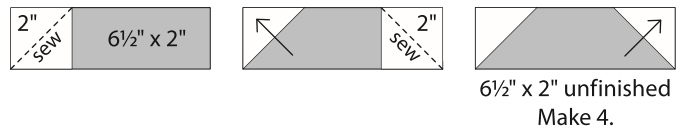

$6\frac{1}{2}$ " x 2 " unfinished
Make 4.

(C) Assemble the tree as shown.

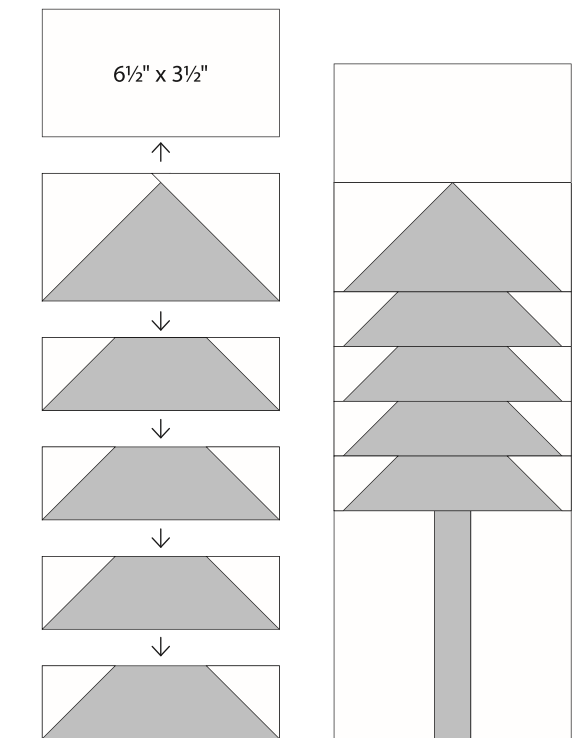

Tree
 $6\frac{1}{2}$ " x $18\frac{1}{2}$ " unfinished

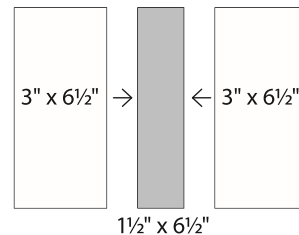

moda

2 House

(A) Draw a diagonal line from corner to corner on the wrong side of 2-4 1/4" background squares. Layer a 4 1/4" marked background square, right sides to together, on 1-8" x 4 1/4" roof rectangle as shown. Sew on the diagonal line. Trim 1/4" from the sewn line. Press to reveal the triangle. Repeat on the opposite end of the same rectangle. Make 1.

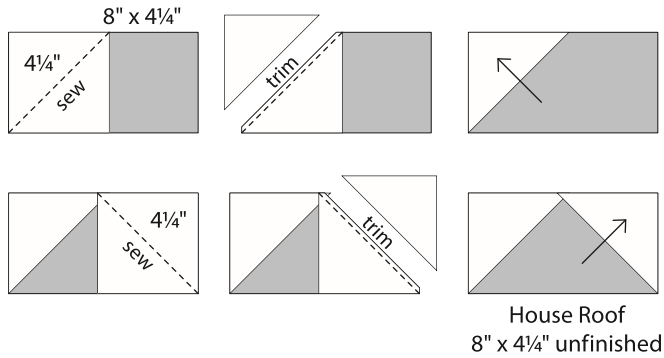

(B) Draw a diagonal line from corner to corner on the wrong side of 8-2 1/4" star point squares. Layer 2 1/4" marked star point square, right sides to together, on 1-4" x 2 1/2" house rectangle as shown. Sew on the diagonal line. Trim 1/4" from the sewn line. Press to reveal the triangle. Repeat on the opposite end of the same rectangle. Make 4 star points.

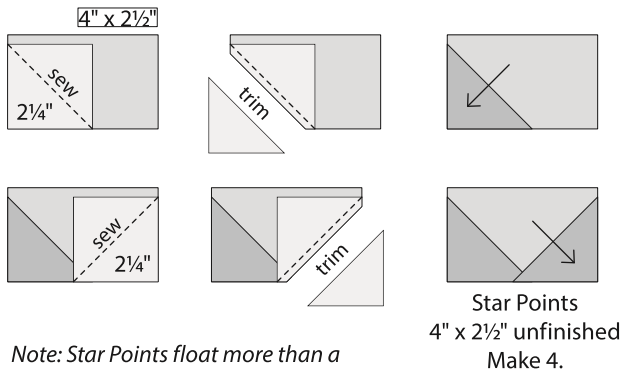

Note: Star Points float more than a 1/4" from the edges.

(C) Assemble the star as shown.

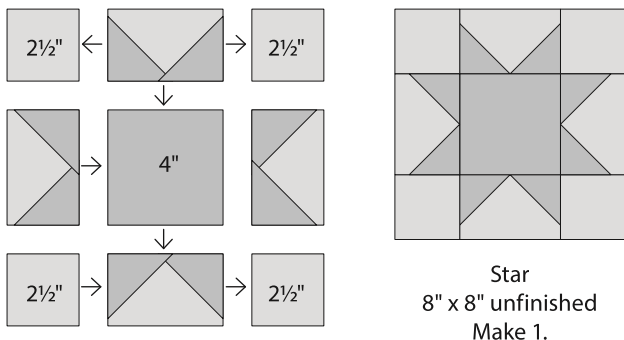

3 Assemble the block as shown. Use fusible web and a zig zag or blanket stitch to add the bird to the completed house block.

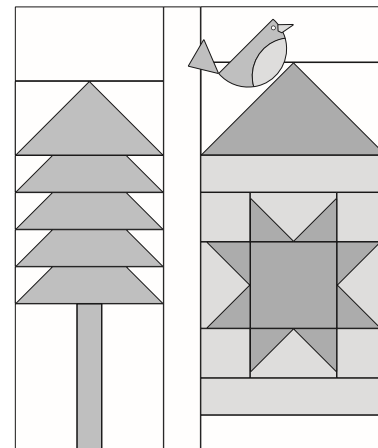
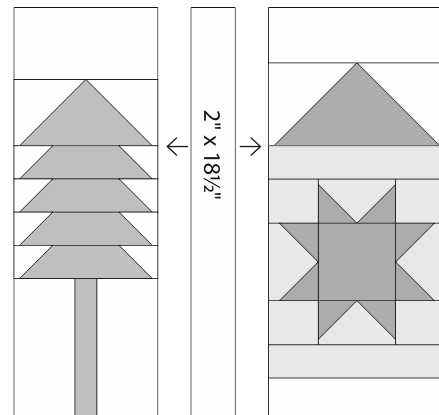
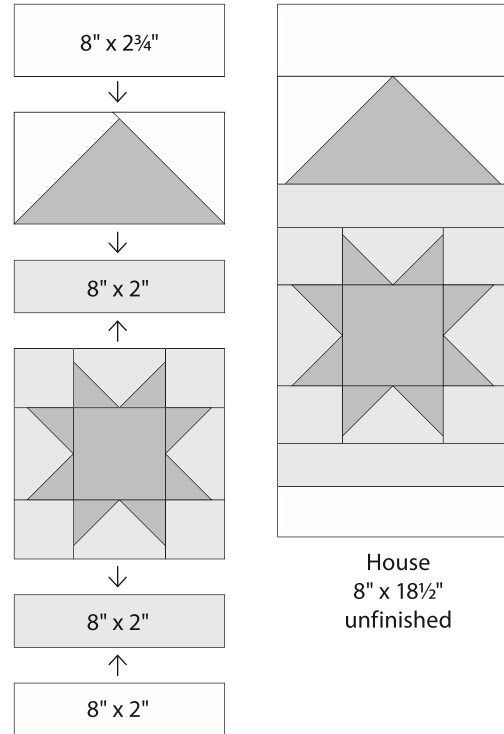

Block 10
15 1/2" x 18 1/2" unfinished

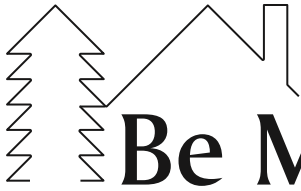

moda

Be My Neighbor

Block 11

21" x 18" finished

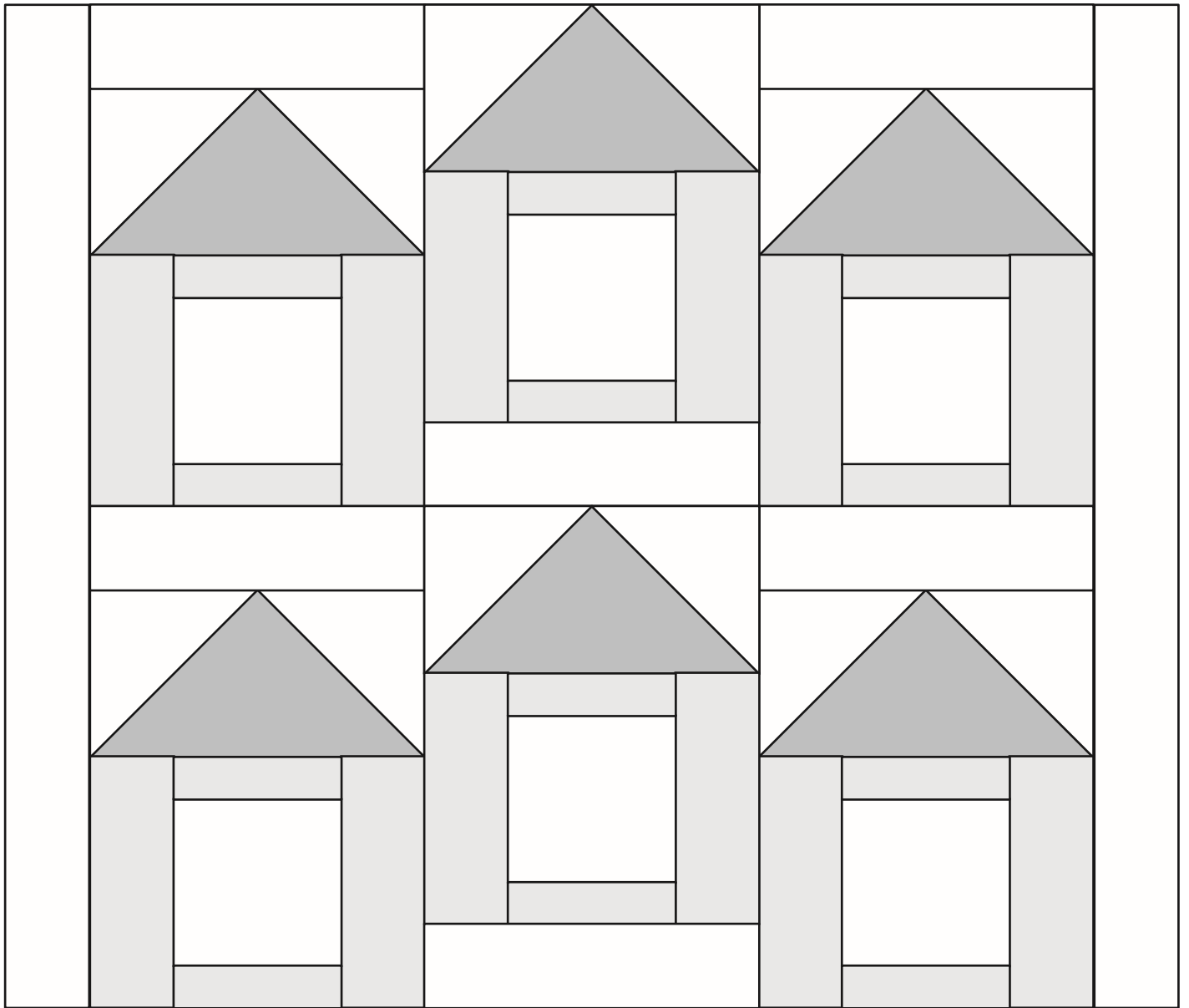

General Information

- These are very scrappy blocks. Mix your favorite Moda prints to create your colorful neighborhood!
- Share your progress and final quilt at #BeMyNeighbor. We love to see your results!!!

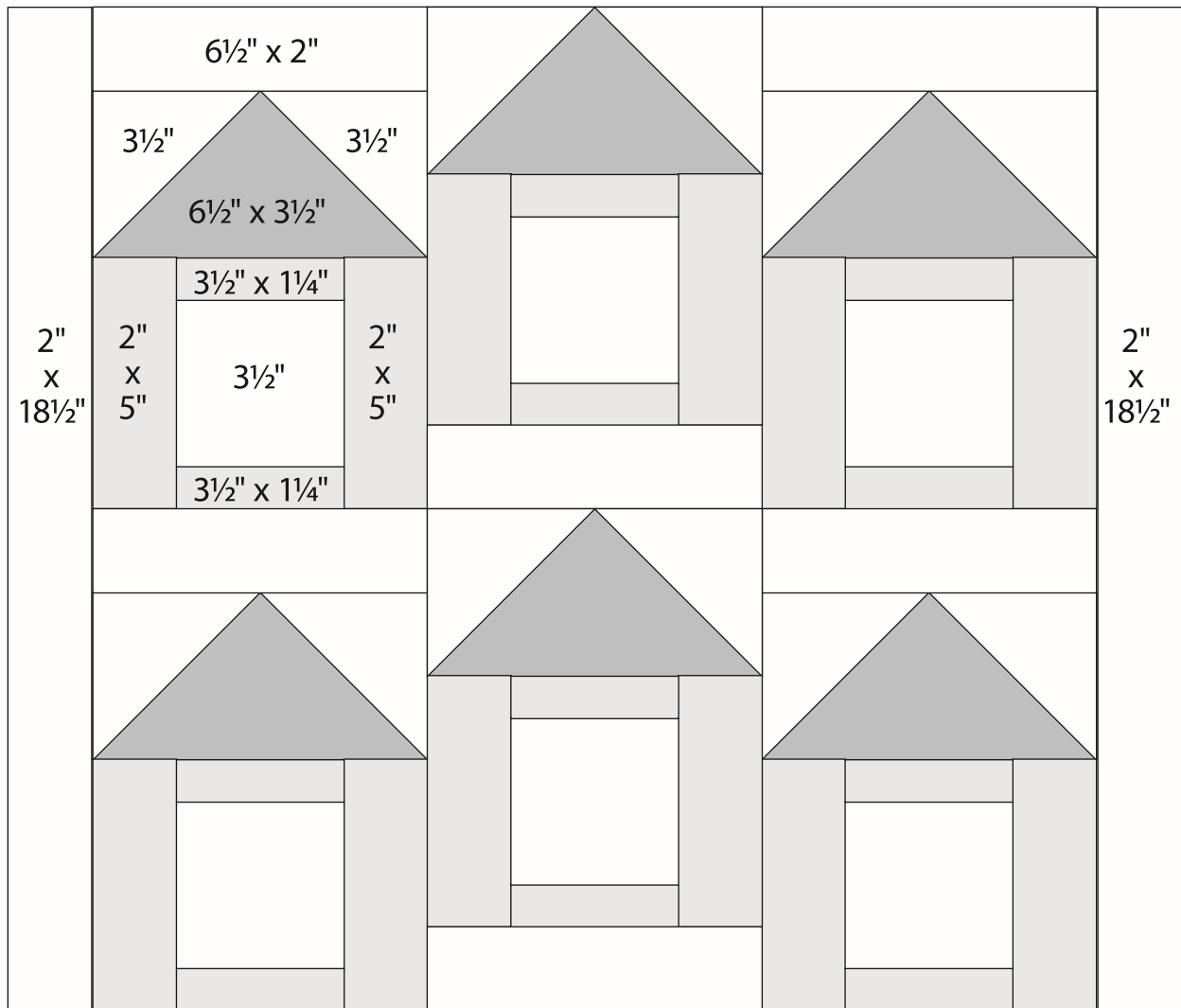

Block 11
21½" x 18½" unfinished

Cutting

House Roof

6–6½" x 3½" rectangles

Window

6–3½" squares

House

12–5" x 2" rectangles

12–3½" x 1¼" rectangles

Background

6–6½" x 2" rectangles

12–3½" squares

2–2" x 18½" rectangles

moda



moda
Be My Neighbor

Block 11 is 21" x 18" finished.

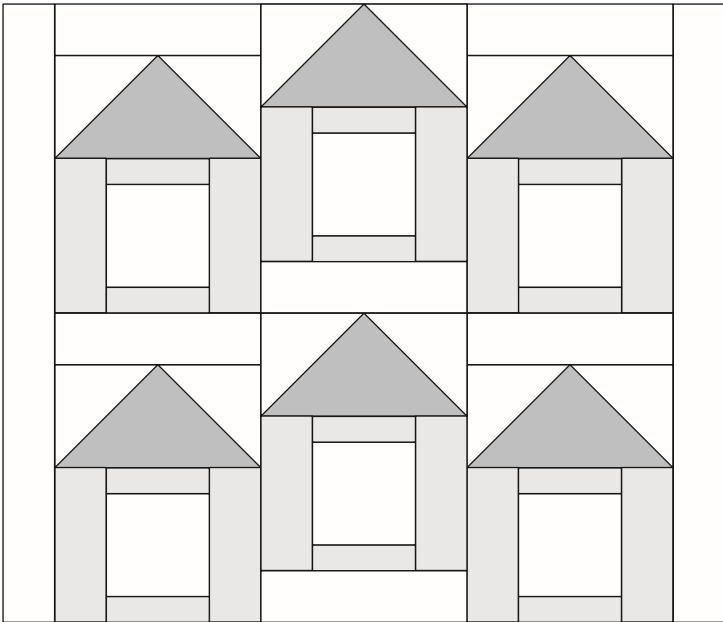

Construction

Use 1/4" seams. Press in the direction of the arrows in the diagrams.

- 1 House Roof**
Draw a diagonal line from corner to corner on the wrong side of 12-3/2" background squares. Layer a 3-1/2" marked background square, right sides together, on 1-6-1/2" x 3-1/2" roof rectangle as shown. Sew on the diagonal line. Trim 1/4" from the sewn line. Press to reveal the triangle. Repeat on the the opposite end of the same rectangle. Make 6.

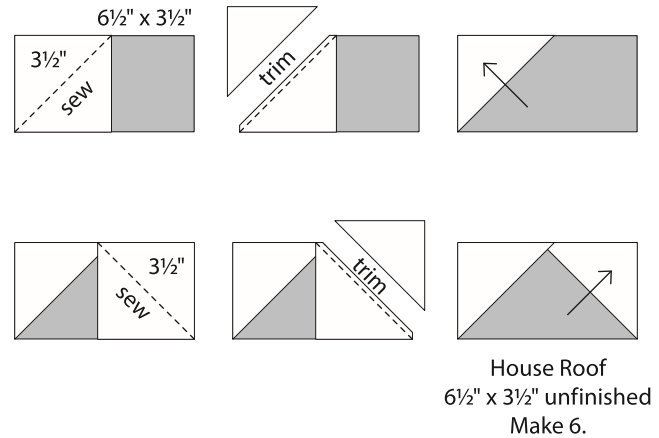

- 2 Assemble the house as shown.**

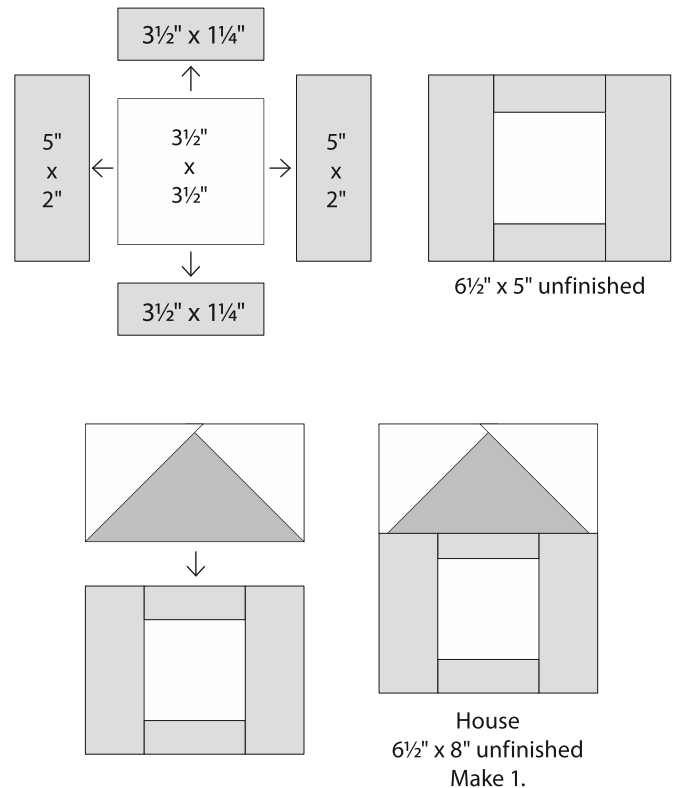

moda

3 Assemble the block as shown.

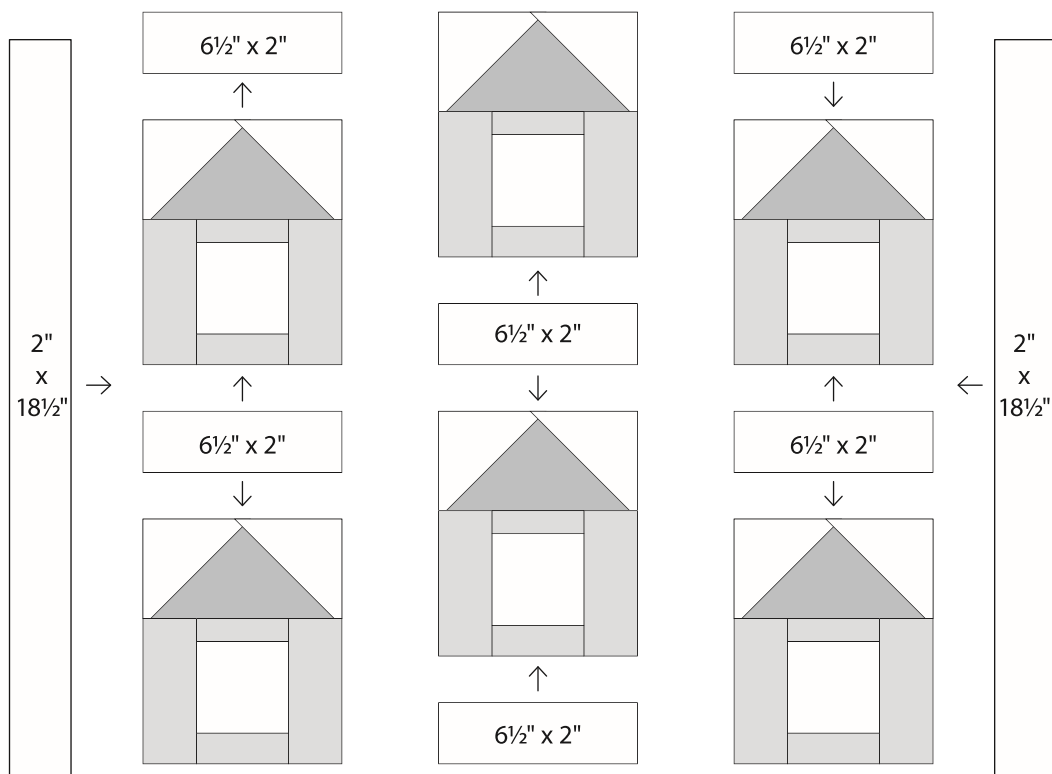

moda

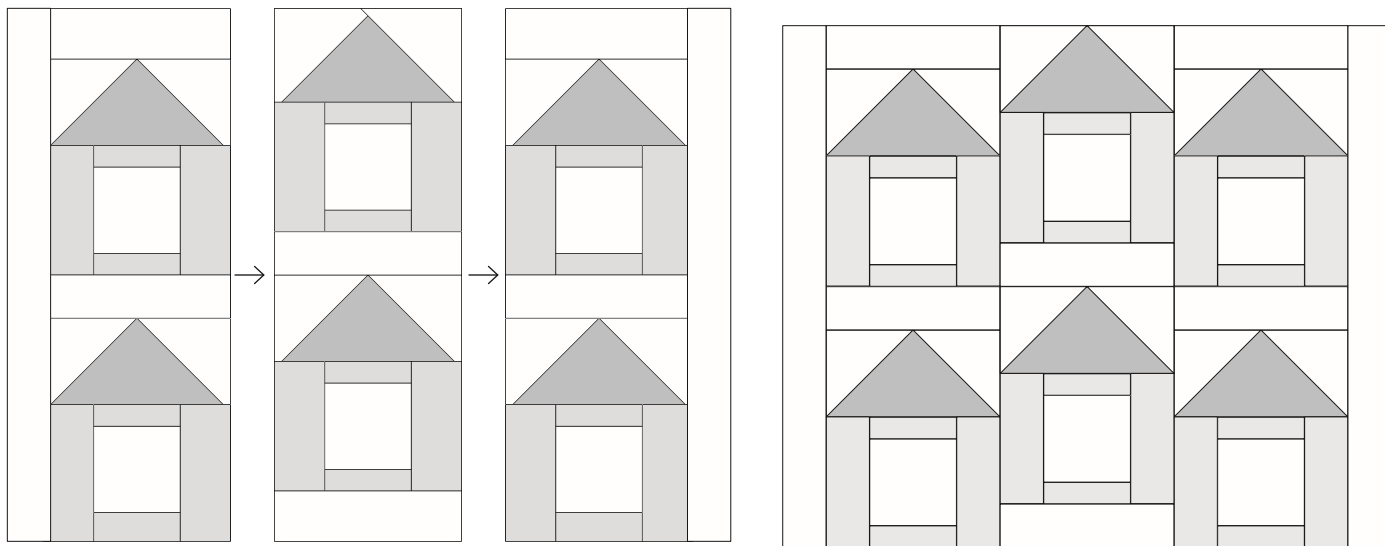

Block 11
21 1/2" x 18 1/2" unfinished